

EXPERIMENTAL FULL SCALE TESTS ON VORTEX GENERATORS FOR HEAVY VEHICLES DRAG REDUCTION

Ramon Miralbes Buil, David Ranz Angulo, Juan Antonio Peña Baquedano

Universidad de Zaragoza, Escuela de Ingeniería y Arquitectura, Departamento de Ingeniería de Diseño y Fabricación, Profesor Contratado Doctor, DIDYF C/María de Luna s/n 500018 Zaragoza, 876765069, miralbes@unizar.es

Received: 22/Feb/2017--Reviewed: 27/Feb/2017--Accepted: 7/Jun/2017- DOI: <http://dx.doi.org/10.6036/8321>

ABSTRACT:

This article details the analysis of experimental tests regarding the behavior of some vortex generators (VGs) for heavy vehicles. The correlation between numerical and experimental tests, including road tests, smoke and water jet tests, etc. will be highlighted.

Two types of vortex generators have been tested, from which high decreases in the drag coefficient in the virtual tests by means of CFD tools were obtained. These vortex generators are one co-rotational with blade shape VG and the other one with a complex geometry, manufactured by the Air Tab Company.

On the other hand, some new low-cost experimental tests have been planned. They do not include the use of a wind tunnel. It has also been necessary to build some functional prototypes of the VGs. It must be highlighted that the use of these types of tests stems from the need to obtain experimental test results to be compared with the numerical results. It must also be pointed out that, due to their high costs, wind tunnel tests have not been conducted to validate the numerical results. However, road test results have proved useful in obtaining the behavior and aerodynamic improvements of the VGs.

Keywords: → vortex generators, aerodynamic, heavy vehicle, articulated, experimental, trailer.

RESUMEN:

El objetivo de este artículo es el análisis experimental del comportamiento de diversos generadores de vorticidad (VG) existentes en el mercado utilizando herramientas experimentales como ensayos en ruta, ensayos de chorro de agua, etc. y su correlación numérico-experimental

Se han comparado dos tipologías diferentes de generadores de velocidad en las que se han obtenido altas reducciones en el coeficiente de penetración aerodinámica utilizando herramientas virtuales CFD. Estos generadores de vorticidad son por un lado uno co-rotacionales con forma de aleta y otro con forma compleja de la empresa AirTab. Por otro lado se han desarrollado diversos ensayos experimentales de bajo coste para evitar el uso del costoso túnel de viento y se han desarrollado diversos prototipos funcionales utilizando la tecnología de la impresión en 3D. Se debe indicar que, debido al alto coste del túnel de viento ha sido imposible realizar este tipo de ensayo pero se han realizado ensayos reales en ruta para obtener el comportamiento real y la mejora aerodinámica de los diversos generadores de vorticidad.

Palabras clave: generador de vorticidad, aerodinámica, vehículo articulado pesado, experimental, tráiler.

1. - INTRODUCTION / STATE OF ART

Nowadays, several factors, such as the high price of fuel, the greenhouse effect and dwindling non-renewable energy sources to name but a few, have had an impact on the automobile industry and encouraged the production of more energy-efficient, less polluting vehicles. In turn, this has led to modifications in vehicle-design criteria, as well as to the development and application of techniques suited to such purposes. Aerodynamics, which allows the optimization of vehicles by merely varying their external design, modifying their superficial finish, adding aerodynamic improvements and diminishing tolerance between component parts, are examples of such techniques and design strategy.

Great changes have been made regarding the external appearance of vehicles with the purpose of reducing both their transversal area and their aerodynamic drag coefficient, replacing their straight lines of yesteryear with new, sinuous shapes and more stylized profiles, as the studies by Morelli (2000)[1] indicate. These developments are the result of the application of strict efficiency and economic profitability criteria, since approximately half of the energy used by a

vehicle goes towards counteracting the resistance of the atmosphere. This in itself would suffice to prove the importance of improving aerodynamics, as the only way to overcome this invisible obstacle.

The studies by Wood and Bauer (2003)[2] indicate that over the last thirty years, the average drag coefficient of more energy-efficient models has gone down by 40%, an improvement entailing a 19% reduction in fuel consumption; As for heavy vehicles, as indicated in the studies by Velury et al.[3] the energy used by a vehicle to overcome aerodynamic drag depends on the vehicle's speed; for heavy vehicles, it is generally estimated that 1/3 of the total drag is caused by aerodynamic drag.

It is essential for the development of more environmentally friendly vehicles that further improvements be carried out, entailing a feasible 15% reduction in fuel consumption.

Today there are some research applications of aerodynamic improvements (patents and commercial parts) for trailers, like nosecones (NOSECONE tm company) [4] (to reduce aerodynamic losses in the kingpin gap), boat tails (for the end of the vehicle studied by Visser (2005) [5], under-skirts and the use of vortex generators (for the kingpin gap and for the rear end of the vehicle). Nevertheless, these improvements, as the IRTE [6] indicate, have usually not been tested, or on many occasions, just one, usually insufficient type of test has been conducted: road tests, scale prototype tests in a wind tunnel or Computer-aided Fluid Design (CFD) analyses.

This is so because while road tests indicate real fuel consumption of the vehicle, they do not provide the engineer with any other additional useful data regarding wind flow and thus, do not allow for vehicle optimization. In the case of CFD analyses, a variety of data is provided (flow lines, pressures, turbulences, particle velocities, etc.) However these data must be validated through other types of tests, as indicated by Chowdhury, Moria, Ali, et al. (2012) [7]. Wind tunnel tests, the best validation approach for numerical simulation, tend to be used as it is possible to control boundary conditions. This is due to the fact that computational domain boundaries naturally mimic the tunnel walls which do not exist in the open road test, as well as the fact that both wind tunnel and numerical models are not affected by open road uncertainties. Cheli, et al. (2011) [8] pointed out that with full-scale wind tunnels to test these kinds of vehicles being non-existent, there is a need to validate scaled model tests given the fact that, despite their similar behavior, results do not fully match. Wind tunnel tests are too costly (due to manufacture of the prototype and the use of the wind tunnel) and usually, real life behavioral patterns of the wheel movement and ground effect cannot be reproduced, as indicated by Soderblom, Lofdahl, E., et al. (2009) [9].

The aim of this article is to compare data which has been obtained from actual road tests with the numerical results found in the previous article "Aerodynamic Analysis of Some Vortex Generator Improvements for Heavy Vehicles" by Miralbes (2012) [10], in order to validate the behavior and aerodynamic improvement of vortex generators.

VGs are elements that modify the airflow from an uncontrolled turbulent flow to control. The main conventional VGs are co-rotational rectangular-type vane ones, which have been studied profusely by means of numerical and experimental tools, as pointed out by authors like Zamorano-Rey, G. et. al. [11]. This study compares numerical simulations using CFD with analytical models for two different VG angles (12.5 ° and 18.5°). It obtained a high degree of correlation which indicates that a CFD model can predict VG behavior. VGs are used in many other fields such as in the control of air flow over airplane wings and in the new, highest power wind turbines to monitor turbulence in the blades, with an ensuing reduction in maintenance costs as indicated by Aramendia-Iradi, I. et. Al. [12].

A secondary objective of this article is to analyze the methodologies used in experimental tests with a view to disseminating more affordable possible alternatives with which to obtain real behaviors of aerodynamic improvements through numerical and experimental methods; it must be pointed that a correlation of the results obtained with those from a wind tunnel would be necessary. However, this is usually quite expensive.

In summary, the main objective is to obtain the real behavior of the previous numerically studied VGs and compare results by using both methods; in addition, the obtained results have been compared with other similar sources and will be described in the article.

When looking at results from “Aerodynamic Analysis of Some Vortex Generator Improvements for Heavy Vehicles” by Miralbes [10], it can be noted that CFD tools were used to analyze and design vortex generators for heavy vehicles including semi-trailers and rear-box trucks. Sub-boundary layer VGs were analyzed with some configurations (see fig 1 and 2): co-rotational (model 1), counter-rotational (model 2) and alternated (model 3), as well as the VGs that the Air Tab company marked (model 4). Alternated VGs are similar to those studied by Fernandez, U., et al [13].

Numerical results showed that the models with the best behavior, (see fig 3) are model 4 or Air Tab model (9.46%) and model 1 or co-rotational model (12.46%).

In this article, the zones with the highest aerodynamic losses have been determined by analyzing the results of airflow and particle track and movement as well as turbulent energies and type of flux (laminar/turbulent). It was observed, as indicated by Miralbes and Castejon (2009) [14], that the main turbulent zones in a heavy vehicle are the inferior zone, the wheels zone, the frontal zone and the rear zone / and both the front and rear ends of the vehicle, where the wake appears. In addition, in heavy vehicles another zone appears in the gap between the cab and semi-trailer, the so-called kingpin gap, where the airflow stagnates due to bodywork discontinuity.

Numerical testing was carried out using the commercial CFD software Fluent with the GAMBIT pre-processor tool. However, the same results can be obtained, with the same accuracy, by using other free software, as indicated by Ambrosinol and Funnel (2006) [15], at a similar computational cost. Other studies such as Zamorano-Rey, G. et al. [11] also used the free software package Open Foam, with a high degree of accuracy.

The previous study used a mesh of linear Lagrangian elements meshed together using GAMBIT. To simulate the boundary layer, with a determined thickness of 23 mm, wedge elements were used with an initial size of 6 mm, 3 elements in this thickness and a growth factor of 1.05. The rest of the mesh is composed of tetrahedral elements with a grown factor of 1.2 and a maximum size of 200 mm.

A segregated solution model with a turbulence model based on k- ϵ type realizable RANS equations was used. Non-equilibrated flow equations and the simple-C resolution algorithm were applied to the walls. A study was carried out to archive an independence of the mesh. Six different meshes were used in the study, with the VG model 1 (1M, 5M, 10 M, 20 M, 30 M and 40 Million elements analyzing the drag coefficient, the pressures in the zone and the velocities. It has been determined that with more than 10,000,000 elements, the results are mesh independent and used for the other VGs.

Figure 4 shows a schematic diagram of the co-rotational VGs (model 1) which should be installed with a distance between them of 80 mm, and with an inclination of 15°.

Co-rotational VG has a *rectangular vane type* that has been designed using Lin, 2002 [16] design principles and results for race cars with VGs found by Kuya, Y.; Takeda, K.; Zhang, X.; Beeton, S.; Pandaleon, T. [17]. Thus, a device height (h_{vg}) of 20 mm equal to the height of the boundary layer (previously determined) has been used, with a separation between them of 80 mm ($4 h_{vg}$). The aspect ratio of the vanes has been fixed at 1:4. The angle has been established at the optimum that those authors determined: 15°. On the other hand, the study by Fernandez-Gamiz, G., et al. [18] on sub boundary layer VGs establishes the optimum height at 40% of the height of the boundary layer for single VGs. This variation must be studied in the future.

There are also some previous tests that the Air Tab Company and the MIRA Institute conducted to compare the behavior of some kinds of vehicles, both with and without vortex generators, which are going to be summarized in this section.

The MIRA (Motor Industry Research Association) carried out two high-speed tests as the “Air tabs™ Vortex Generators Technical Trials Articulated HGV” [7] report indicates, using a 28 Tn. trailer with Air Tab only fitted to tractor-trailer gap and a repeat test without.

The MIRA Institute uses a high-speed track that is roughly 4.55 km in length, with lanes for 40mph, 50mph, and higher speeds. The 40 and 50mph sections are not banked, whereas the higher speed section is.

Each study used two tractors with two different drivers; for the tests, the tractors were warmed up prior to the tests runs, the fuel quantity in special tanks weighed, and fuel temperature measured before and after the runs. Each truck did one run while fitted with VGs and one run without the VGs. For each tractor, 15 laps in total were done with, and another 15 without VGs. Of every 15 laps, 5 were made at 40 mph, 5 at 50 mph and 5 at 55 mph, with an average speed of 76 Km/h. As figure 5 indicates, there was an improvement in fuel consumption of 1.53% and 1.81% for each tractor.

Another test is reflected in the “Lockheed Georgia Low Speed Wind Tunnel Honda Civic Hatchback Air Tab Modification Results” [19], a report that was made from results of tests done in the Lockheed Low Speed Wind Tunnel facility in the State of Georgia, USA. The author’s aim was to confirm that the introduction of forced, arrayed, stream-wise, near-wake vorticity would serve to increase pressure at the base area of a moving vehicle, thereby reducing aerodynamic drag force. A series of unmodified (baseline) and modified (with Air Tab vortex generators) wind tunnel runs were conducted. The runs were made at a constant speed (55mph/88 Km/h) and over a fixed range of yaw angles, with a 1982 Honda Civic Hatchback. This vehicle in particular was chosen for two reasons: The vehicle had a small enough cross-sectional area to permit statistically valid, un-corrected data runs in the chosen wind tunnel without turbulent side wall interference problems, and the vehicle design offered a generous base area enabling the acceptance of an approximately 50 sensor pressure grid to measure base pressure data for each run. The vehicle was fixed with this pressure sensor grid and mounted on metric plates embedded in a large turn table inside the wind tunnel to allow the vehicle to experience different yaw angles (-4° to 30°).

Results indicated that the use of Air Tab reduces the coefficient of drag (Cd) for any yaw angle and is greater at higher yaw angles (see figure 6); on the other hand, pressure sensors showed a decrease in pressure for all sectors with the vortex generator, which indicates a reduction of the drag forces. Furthermore, the tests indicated that the horsepower required to maintain 55mph dropped from 9.79 to 9.38 with Air tabs installed, a reduction of 0.41 HP or 4%. Air tabs were omitted from the roofline in order to obtain the most symmetrical data runs possible. A conservative extrapolation of these test results indicate that roof mounted Air tabs™ would improve on these findings by about 50% and translate to a further HP reduction of 2%, resulting in an overall reduction of 6%.

Another set of tests were conducted in a wind tunnel. This time, with the vehicle moving from left to right, with a scale trailer model with and without Air tabs in the tractor near the gap, to compare the airflow behavior. Figure 7 shows the results; in the left hand photograph, note how much smoke is in the gap between the tractor and trailer without Air tabs being fitted. This represents aerodynamic inefficiency and drag, which takes horsepower to overcome. When Air tabs are fitted, as in the right hand photograph, the vortices generated by the Air tabs carry most of the smoke past the tractor/trailer gap; this is a much more efficient aerodynamic configuration.

There is more evidence of the benefits of vortex generators like Air tab, described on its web site. It indicates that its use results in fuel savings between 2 and 5% while improving vehicle stability, reducing lane excursions and roll over risk as well as improving handling in gusty wind conditions. Additionally it enhances rear view mirror visibility and safer lane changes in rain or snow.

Fuel economy improvements are achieved by aerodynamic drag reduction at two key locations: the tractor-trailer gap and the back-facing surface of any square backed vehicle or trailer, including RVs, buses, straight trucks and cube vans. Air tabs improve vehicle stability by altering the airflow at the vehicle’s rear: the large random swirls at the rear doors are changed into dozens of small vigorous “stream-wise” counter-rotating vortexes that trail behind the vehicle; this increases stability, improves handling, reduces driver workload and fatigue and moreover, improves driver safety margins by reducing adjacent lane incursions.

Mirror visibility in rain or snow is also improved as Air tabs help suppress vehicle spray, thus improving safety through better mirror visibility, yielding safer lane changes.

The vortex generator also reduces snow (weight) and grime accumulation at the vehicle rear, so cleaning costs are reduced and safety is improved by keeping conspicuity tape, tail and brake lights cleaner.

Ken Slaughter [20] indicates that he made, with a trailer, some real road tests with and without Air tab and similarly obtained a reduction in fuel consumption from 22-23 MPG to 21-22 MPG (4-5%).

2. - MATERIAL AND METHODS

The main objective of the experimental tests is to obtain the real-world behavior of VGs and compare it with numerical results. It must be pointed out that although numerical models and prototypes used in wind tunnel tests are usually similar, they are not equal to real vehicles (as windshields, mirrors, underbody structure, rotating tires, etc. tend not to be included) Therefore, while results are similar to those of a real vehicle they are not equal either. They are more similar to those results coming from a real heavy vehicle which includes windshields, mirrors, underbody structure, and rotating tires than those obtained from wind tunnel scaled models or numerical models.

It must be pointed out that numerical results should be validated and the most similar method of validation would involve the use of an air tunnel. There arise some drawbacks and problematic areas for heavy vehicles as it is impossible to test a non-scaled model due to shortcomings regarding dimensions and power of the wind tunnel. Thus vehicles must be scaled with the necessity to build a functional prototype of the vehicle, with ensuing economic and time costs. Furthermore, it is difficult to obtain the behavioral patterns of a vehicle on a real road by means of a wind tunnel given the fact that these patterns are difficult to reproduce (especially the effects of the rotation of the wheels in the air); in addition, road tests conditions tend to be uneven, owing to external factors which may influence final results (speed, vehicle speed, temperature, atmospheric pressure, etc.), with all this making it difficult to achieve repetitiveness. Due to these constraints, aerodynamic studies and optimizations include CFD analysis in some phases of the design, since it allows easy and lost-cost modification of geometry, and test repetitiveness is fully achieved. This way results and models can be easily compared in order to obtain the best design. On the other hand, the real behavior of the design must be validated by means of experimental tools in order to carry out its comparison with the numerical behavior of the vehicle. Nevertheless, it is simpler and more economical to stick to the comparison of the initial and final design. Two types of test have been carried out: road tests using a car; and road tests using a van, all with a view to obtaining their actual behavior to be subsequently compared with experimental behaviors. For that, prototypes of co-rotational VGs had to be built.

For these tests, a reference vehicle was required. It was necessary, therefore, to select a car and a van with a similar shape; the car had to have the same transversal area as the one for the Honda Civic model used in the Lockheed experimental test.

For both types of test, it is necessary to control vehicle speed by means of a cruise control and to monitor it by means of a GPS device. Additionally, atmospheric parameters with an influence on the aerodynamic behavior of the vehicles have to be controlled, and this necessitates making use of a meteorological station.

The influence of atmospheric conditions can be avoided by testing during good weather, and if possible, over consecutive days. Testing should commence each day at the same hour. Testing must include the vehicle without VG, with the Air vortex VG and with the co-rotational VG. Testing should be done over consecutive days while keeping the same schedule so as to obtain valid comparable results.

When testing, the same vehicle with the same weight and quantity of fuel must be used; vehicles must be refueled with their total weight verified for each test, each day. Tire pressure must also be verified, and to avoid the influence of a cold engine, a 30 minute road trip must be made each day of testing prior to the actual testing.

A season and time of the day with favorable weather conditions must also be selected in which temperature variations are slight.

Another important aspect of the test is the selection of the track. A road without heavy traffic and with small variations in orography must be used. To avoid the influence of traffic on results, motorways should be used.

The results that must be obtained are those accounting for fuel consumption, average speed, and meteorological data.

3. - RESULTS

3.1. - ROAD TESTS USING A REFERENCE CAR VEHICLE

The first tests have been carried out using a car similar to the Honda Civic used in the Lockheed test. For the experimental tests, a car with an on-board system controlling and recording variables such as real-time instantaneous consumption, total consumption, distance run and duration, along with average speed was used. The vehicle was equipped with a cruise control system enabling constant speed independently of the driver with a precision of ± 2 Km/h. A portable GPS was used to monitor some of the parameters of the on-board computer. The vehicle selected was a Renault Megane CC (see fig. 8) with no spoiler at the rear and whose geometrical lines change abruptly. This vehicle has been selected since it has similar transversal area and rear end geometry to the Honda Civic.

To select the route, prerequisites were as follows: A high capacity road such as a motorway should be used, with a predominantly flat orography and with low vehicle density to reduce traffic influence. Approximately 60 Km were to be made in each test, in 30-40 minutes. Cruise control was set at 120 km/h trying to minimize driver's input in order to obtain valid result for repetitiveness.

In accordance with these restrictions, a stretch of the Spanish highway system was selected. Prior to testing, the vehicle was warmed up over a distance of 50km. Testing was carried out with a specific starting and ending point for the route (both indicated by a road sign, with the vehicle keeping a constant speed of 120 Km/h, controlled by the journey controller and the on-board computer, with the on-board computer/ cruise control being reset at this point). 18 tests were carried out (3 days x 3 journeys x 2 directions) in successive days; during the same day the vehicle was tested with and without each VG since the atmospheric conditions were to be similar (temperature, pressure as well as wind direction and intensity were monitored by using a portable meteorological station and the temperature sensor of the vehicle). Testing days were previously selected by using the information gathered from the Spanish Meteorological Agency (AEMET). Some weeks were selected in spring (May) as testing days were to be sunny, with low wind and consistent air pressure. Thus the influence of environmental factors like wind, temperature and air pressure on fuel consumption could be minimized or avoided while obtaining more consistent test conditions from which to compare results.

Test results are shown in Table III. (An improvement of 1.76% in fuel consumption and 3.12% for the co-rotational VG can be seen when analyzing the results with the use of Air Tab VGs) *and as if it has been obtained analyzing these results with the Air Tab VGs, it has been obtained an improvement of the 1.76% in the fuel consumption and for the co-rotational VG 3.12%.*

All types of vortex generators were installed using Air Tab's recommended installation procedure. [21]

For fuel consumption data, on-board CPU results were used. Additionally, the fuel tank was totally re-filled to a previous established level and the fuel required to that aim measured. Total fuel consumption was thus obtained with both of these measurements.

It must be pointed out that, when all round trips and all return trips are compared, the uncertainties in the test results, calculated in the average fuel assumptions, are ± 0.1 L. On the other hand, under similar road conditions, the results with VGs tend to be better than without, and the results of co-rotational tend to be better than results for Air Tab VG, so results can be used to establish the approximate improvement in fuel consumption.

3.2. - ROAD TESTS USING A REFERENCE VAN VEHICLE

The desired outcome of these tests is to be able to correlate the results / The objective of these tests is the correlation of the results obtained in the numerical tests for a reference box trailer by using an equivalent vehicle. Thus, a van with a

box configuration has been selected as well as an IVECO DAILY of 10 m³ (see fig. 9). This vehicle was rented and fitted with equipment with similar capabilities to those for the car, and the same portable GPS from section 4.2. The road tests performed were similar to those of section 4.2 (route, time frame, atmospheric conditions, season, etc.) but with a constant speed of 100 km/h.

As we can see in figure 10, an improvement in fuel consumption of 1.74% with Air Tab VGs and 3.74% with the co-rotational VG has been obtained. (These are the average results of six trips).

All types of vortex generators were installed using Air Tab's recommended installation procedure. [21] To obtain fuel consumption, on-board CPU results were used, and the fuel tank totally re-filled to a previous established level with the fuel needed measured to obtain fuel consumption. With both measurements, from the CPU and measurements of fuel refills, fuel consumption was obtained.

It must be pointed that if all round trips and all return trips are compared, the uncertainties in the test results, calculated in the average fuel assumptions, are ± 0.1 L. On the other hand, with similar road conditions (consecutive test), results with VGs tend to be better than without and the results of co-rotational tend to be better than results for Air Tab VG, so results can be used to establish the approximate improvement in fuel consumption.

4. - RESULTS ANALYSIS AND DISCUSSION

The results can be analyzed from two different perspectives: flow consumption and flow analysis.

4.1. - FUEL CONSUMPTION RESULTS

When analyzing those results collected in Table I and summarized in figure 11, a series of conclusions can be drawn. On the one hand, when comparing car results with those results from the Honda Civic with Air Tab, we can see a reduction in drag coefficient (CD) of 4.14%. If it is assumed that the test speed, accounting for approximately 40% of the consumption of fuel, is used to achieve greater aerodynamic forces for a car, as indicated by Canet, Bugada and Oñate [22] then improvement in fuel consumption will be approximately 1.65%. On the other hand, the road tests of section 4.2 with a Renault Megane yielded an improvement of 1.76% with the Air Tab VG and 3.12% for the co-rotational VG.

Furthermore, when comparing results for trailer type vehicles, it has been observed that the MIRA tests where some Air Tab VGs were installed in the kingpin gap, an improvement of 1.66% in fuel consumption ensued, with a 3.76% improvement for numerical test, using VG in the rear part and in the kingpin gap. Then it can be assumed (based on a 50% improvement in each zone; and similar to the numerical results obtained for co-rotational VGs), that the improvement obtained numerically for the kingpin gap is approximately 1.8%, quite similar to the experimental results. On the other hand, the results obtained from the road tests with the IVECO van, where both types of VG in the rear zone simulate the rear zone of a trailer, an average improvement of 1.74% has been obtained for the Air Tab VG and 3.76 for the co-rotational VGs. These experimental results are higher than the numerical ones for the rear zone of the vehicle (2.37%). Nevertheless, it must be pointed out that the van was carrying no load; therefore, the aerodynamic influence on fuel consumption should be lower and then the results more similar.

Ken Slaughter indicated that he had obtained a 4% improvement in fuel consumption using Air Tab in both zones; whereas numerical results indicate an improvement of 3.78%.

4.2. - FLOW ANALYSIS RESULTS

In the upper part of figure 7, it can be observed that, regarding the model without VGs, smoke appears in the kingpin gap area. This accumulation of smoke is caused by its shape, which indicates a zone where air flow accumulates. We can see high energy losses in this area due to this effect, which can be reduced by using VGs as seen in the second

image (figure 7) Therefore, this indicates that the VG controls air flux outside the kingpin gap, thus decreasing turbulence and energy losses in this area.

Numerical results (see figure 11) indicate the same behavior for the kingpin gap, with lower turbulent energy for the VG models 1 and 4 when compared with models with VG. The same occurs in the rear part of the vehicle where VGs are also installed. This reduction in turbulent energy indicates that VGs can control airflow to reduce the effect of suction in the rear part of the vehicle (due to a zero air velocity and high turbulence zone) and in the kingpin gap. As for VG models 2 and 3, it can be observed that turbulent energy in these zones increases, resulting in higher energy losses.

5. - DISCUSSION

The main conclusion reached in this paper is, as indicated in the previous article “Aerodynamic Analysis of Some Vortex Generator Improvements for Heavy Vehicles”, the fact that the use of vortex generators allows reduction in fuel consumption in heavy vehicles in both key zones: the area of the kingpin gap and the rear zone of the trailer. Furthermore, a high degree of accuracy has been obtained between the numerical results, some previous experimental results and the new experimental results, as reflected in section 5. All this leads to the affirmation of the benefits of well-designed VGs for heavy vehicle consumption.

Furthermore, when comparing both types of selected vortex generators, it can be pointed out that the co-rotational type shows a better behavior than the Air Tab’s one, with fuel consumption reductions of 4-5% in a trailer. This improvement is also possible for cars (in this case, car shape is a key factor, and some more detailed analyses must be made, comparing diverse types of cars) and for vans.

BIBLIOGRAPHICAL REFERENCES

- [1] Morelli, A.; “A New Aerodynamic Approach to Advanced Automobile Basic Shapes”; SAE. Technical Paper n° 2000-01-0491. 2000.
- [2] Wood, R.M.; Bauer S.X.S.; “Simple and Low Cost Aerodynamic Drag Reduction Devices for Tractor-Trailer Trucks”; SAE Paper n° 2003-01-3377; 2003
- [3] Veluri, S. P.; Roy, C. J.; Ahmed, A.; Rifki, R.; Worley, J. C.; Recktenwald, B.; “Joint Computational/Experimental Aerodynamic Study of a Simplified Tractor/Trailer Geometry”; ASME Journal of Fluids Engineering; Vol. 131, No. 8; 2009
- [4] NOSECONE™, <http://www.nosecone.com/apvan.htm>
- [5] Visser, K.; “Drag Reduction of Tractor Trailers”; Clarkson University, Potsdam New York; 2005
- [6] “Air tabs™ Vortex Generators Technical Trials Articulated HGV, Tractor-Trailer Gap Tests”; IRTE (Institute of Road Transport Engineers) - BTAC Brewing Transportation Advisory Committee; 2007.
- [7] Chowdhury, H.; Moria, H.; Ali, A.; et al.; “A study on aerodynamic drag of a semi-trailer truck”; 5th Bangladesh-Society-of-Mechanical-Engineers (BSME) International Conference on Thermal Engineering (ICTE). Islam Univ Technol, Dhaka, Bangladesh. 2012
- [8] Cheli, F.; Corradi, R.; Sabbioni, E.; et al.; “Wind tunnel tests on heavy road vehicles: Cross wind induced loads-Part 1”; Journal of Wind Engineering and Industrial Aerodynamics; Vol 99, Issue 10, pp 1000-1010; 2011
- [9] Soderblom, D; Lofdahl, L.; Elofsson, P. et al; “An Investigation of the Aerodynamic Drag Mechanisms due to Ground Simulation in Yawed Flow Conditions for Heavy Trucks”; ASME Fluids Engineering Division Summer Meeting, Vail, CO.; Vol 2, pp 313-319; 2009.
- [10] Miralbes, R.; “Aerodynamic analysis of some vortex generator improvements for heavy vehicles”; International Journal of Heavy Vehicle Systems; Vol 19, Issue 4 pp 355-370; 2012
- [11] Zamorano-Rey, G.; Garro, B; Fernández-Gámiz, U; Zulueta, E; “A Computational Study of the Variation of the Incidence Angle in a Vortex Generator”; DYNA; Vol 13. 2015
- [12] Aramendia-Iradi, I.; Fernandez-Gamiz, U.; Sancho-Saiz, J.; Zulueta, E; “Estado del Arte Sobre Dispositivos Activos y Pasivos de Control de Flujo para Turbinas Eólicas”; DYNA; Vol 91, pp 512-516; 2016
- [13] Fernandez, U.; Velte, C.M.; Réthoré, P.E.; Sørensen, N.N.; Self-similarity and helical symmetry in vortex generator flow simulations”, Wind Energy; Vol 19, pp 1043–1052; 2012.
- [14] Miralbes, R.; Castejon, L.; “Aerodynamic Analysis of a Vehicle Tanker”; Journal of Fluids Engineering; Vol 131; 2009
- [15] Ambrosino F.; Funel A.; “OpenFOAM and Fluent Features in CFD Simulations on CRESCO High Power Computing System”; Final Workshop of Grid Projects, Pon Ricerca; 2006
- [16] Lin J.C.; “Review of Research on Low-Profile Vortex Generators to Control Boundary Layer Separation”; Progress in Aerospace Science; Vol 38, Issue 4, pp 389-420; 2012.
- [17] Kuya, Y.; Takeda, K.; Zhang, X.; Beeton, S.; Pandaleon, T.; “Flow Physics of Race Car Wing in Ground Effect with Vortex Generators”; Journal of Fluids Engineering; Vol 131; 2009.
- [18] Fernandez-Gamiz, U.; Zamorano, G.; Zulueta, E.; “Computational study of the vortex path variation with the VG height”. Journal of Physics Conference Series; Vol 65, pp 18-25; 2017

- [19] Ducats, D.J.; "Lockheed Georgia Lowspeed Wind Tunnel Honda Civic Hatchback Airtab(R) Modification Results"; 2009.
 [20] Slaughter, K.; "An Expediter and His AIRTABS"; www.ExpeditorsOnline.com
 [21] Air Tab's recommended installation procedure. <http://www.airtab.com/installation-removal.htm>
 [22] Canet, J.M., Bugeda, G. and Oñate, E. "Simulación Numérica de la Aerodinámica de Vehículos", Centro Internacional de Métodos Numéricos en Ingeniería; 1991.

		Vehicle used	Velocity (Km/h)	None	AirTab	Co-rot VG
Honda Civic Wind Tunnel Test	CD	Car Honda Civic	88	0,4543	0,4355	
	Improvement (%)				4,14	
	Air HP			9,79	9,38	
	Improvement (%)				4,19	
High Speed Mira Test	Fuel Consumption (l/100 Km)	Two Trailers VG Only in Gap	76	30,8	30,29	
	Improvement (%)				1,66	
Ken Slaughter	Fuel Consumption (l/100 Km)	Own Trailer	---	11,2	10,7	
	Improvement (%)				4,46	
Road test with car	Fuel Consumption (l/100 Km)	Car Renault Megane cc	120	7,7	7,6	7,5
	Improvement (%)				1,76	3,12
Road test with van	Fuel Consumption (l/100 Km)	IVECO Van	100	7,9	7,8	7,6
	Improvement (%)				1,74	3,74
Numerical Results	Drag Forces (N)	Trailer with VG rear	80	1709		1607
	Drag Force improvement (%)					5,97
	Fuel Consumption Improvement (%)					2,37
	Drag Forces (N)	Trailer with VG in GAP		1709		1604
	Drag Force improvement (%)					6,14
	Fuel Consumption Improvement (%)					2,56
	Drag Forces (N)	Trailer with VG rear and in GAP		1709	1548	1496
	Drag Force improvement (%)				9,42	12,46
	Fuel Consumption Improvement (%)				3,78	4,98

Table I. Resume Table of results

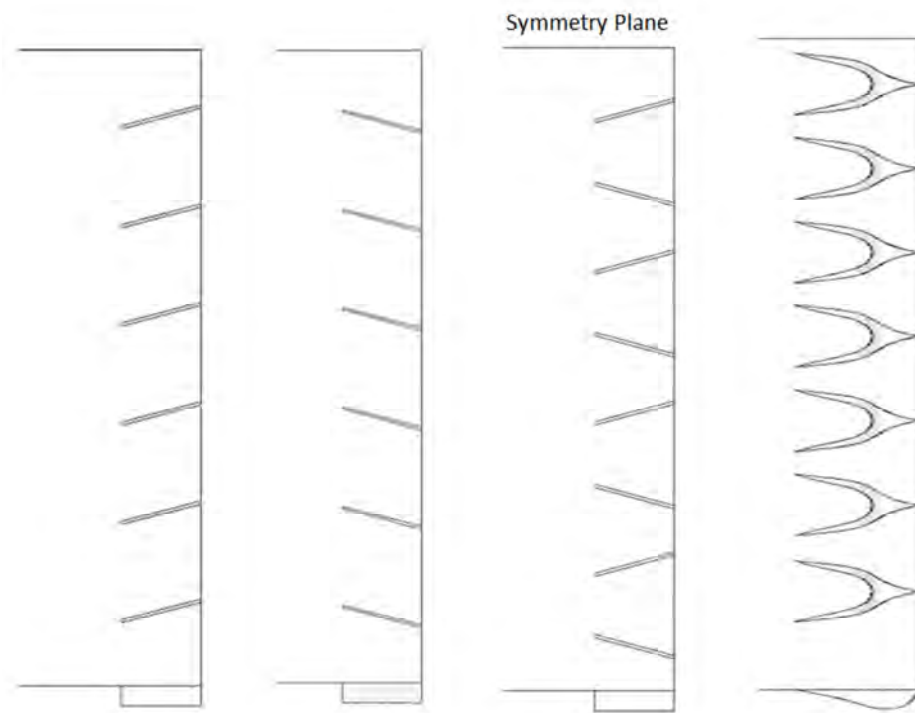

Fig 1: Models 1 (left), 2 (middle-left), 3 (middle-right) and 4 (right). Source: 10



Fig 2. Rectangular shape VG (up) and Air Tab VG (down)

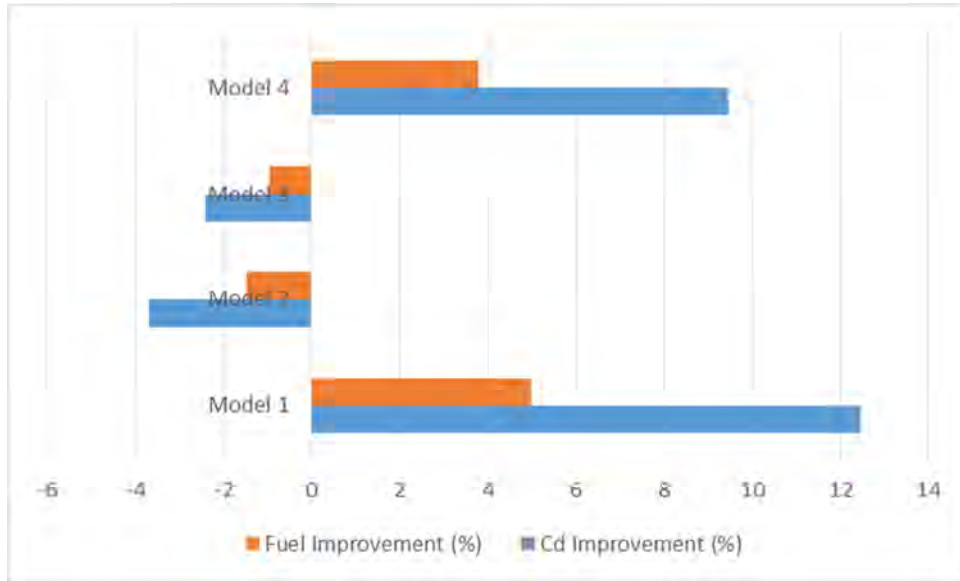

Fig. 3. Total force and fuel improvement for all the models for CFD analysis.

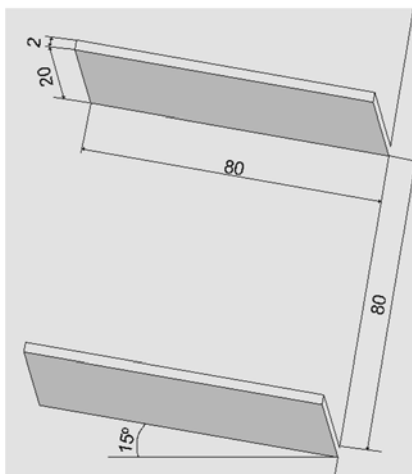

Fig. 4. Schematic diagram of the vortex generator model 1 and 2 and main dimensions (in mm)

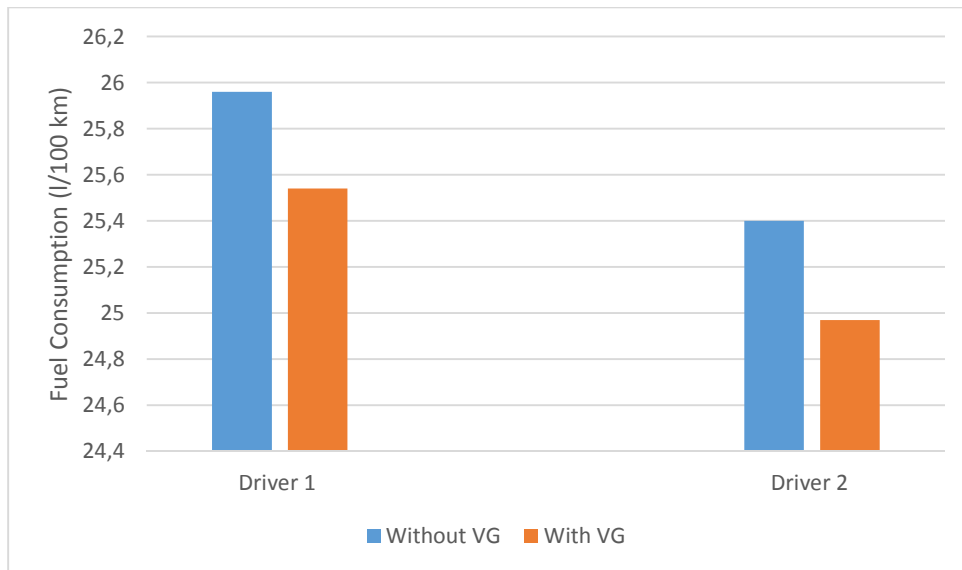

Fig. 5. MIRA experimental results for heavy vehicles with and without Air TAB Bibliographical source: IRTE6

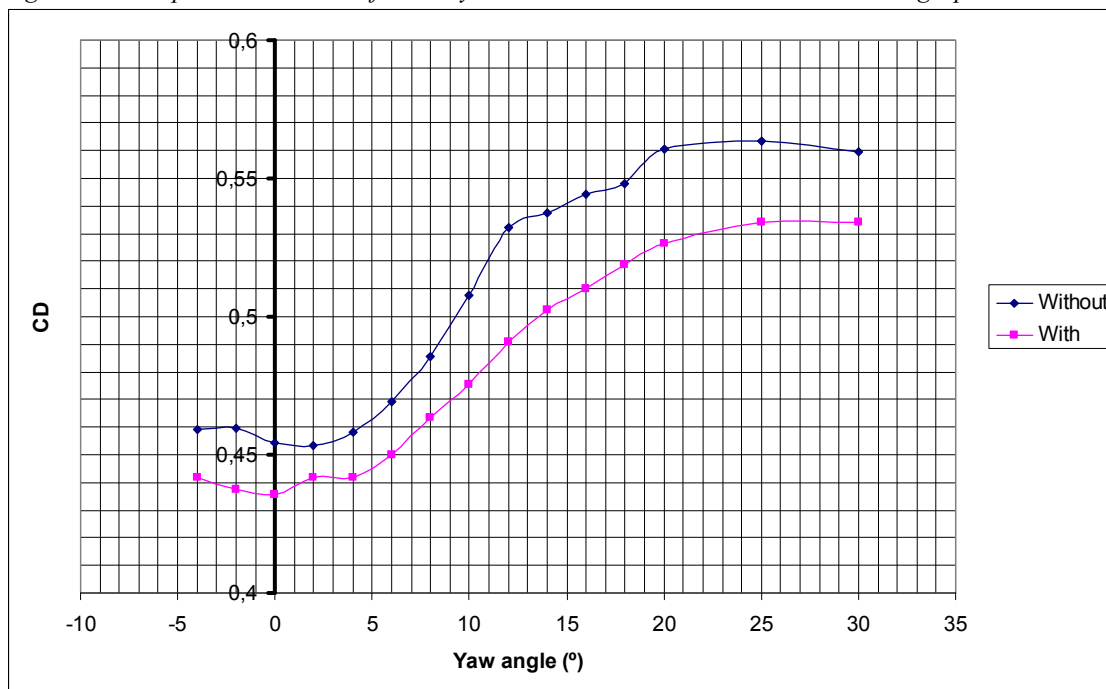

Fig. 6. Plot of yaw angle versus Cd for the Honda Civic Wind Tunnel Tests. Bibliographical source: "Lockheed Georgia Low Speed Wind Tunnel Honda Civic Hatchback Air tab(R) Modification Results"13

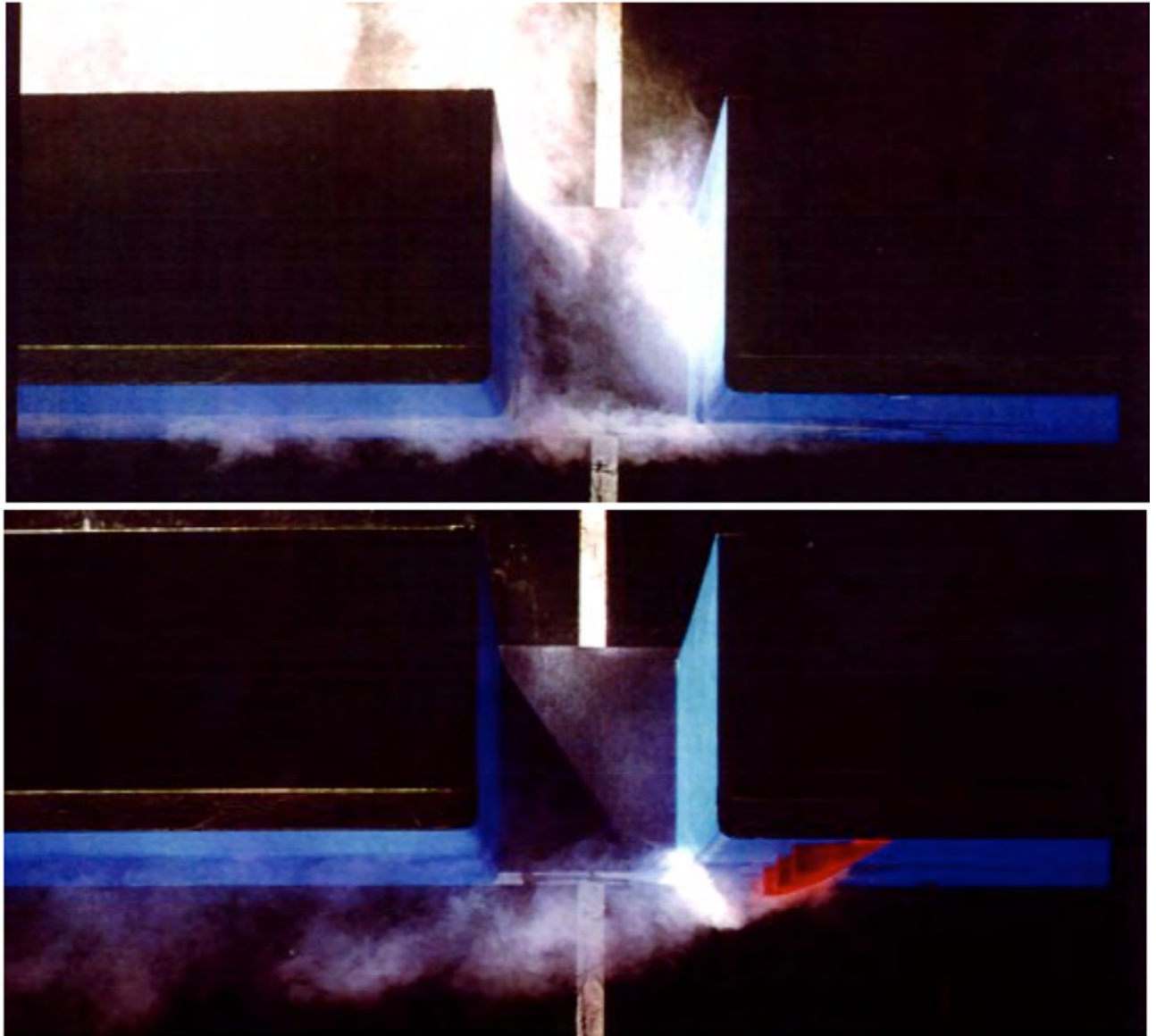

Fig. 7. Airflow for the kingpin gap in a wind tunnel without VG (up) and with VG (down). Bibliographical source: 7



Fig. 8: Renault Megane CC with co-rotational VG (model 1)



Fig 9: IVECO Van with co-rotational Vg (left) and with Air Tab (right) for the road tests

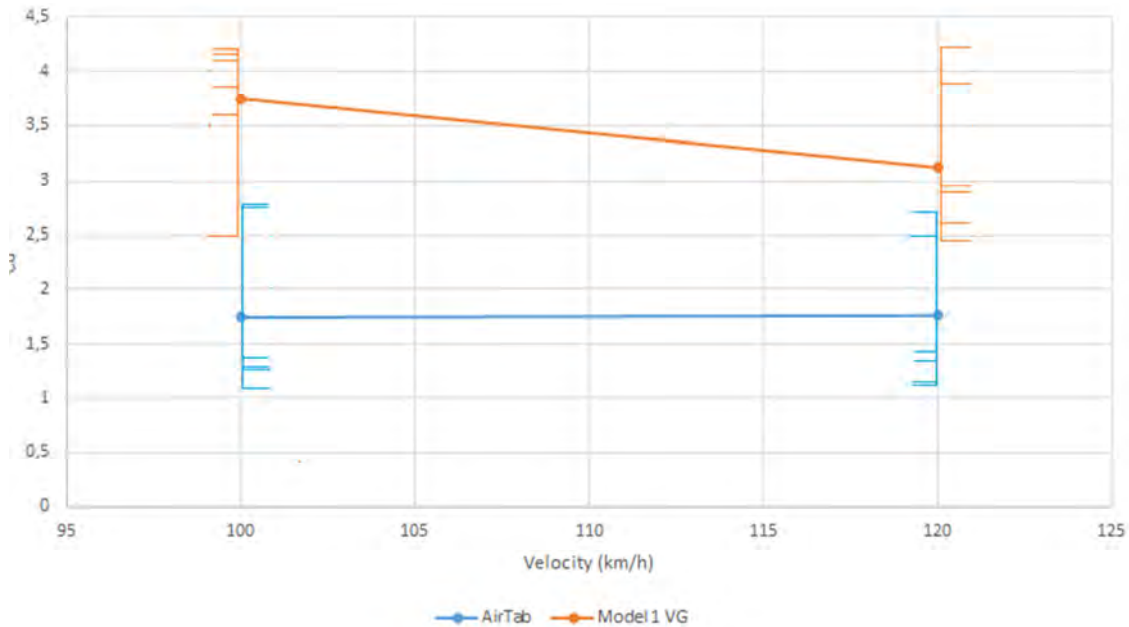

Fig. 10. Road Tests car (120 Km/h) and van (100 km/h) vehicle results for each VG. Big Points: average result; horizontal line: each test result.

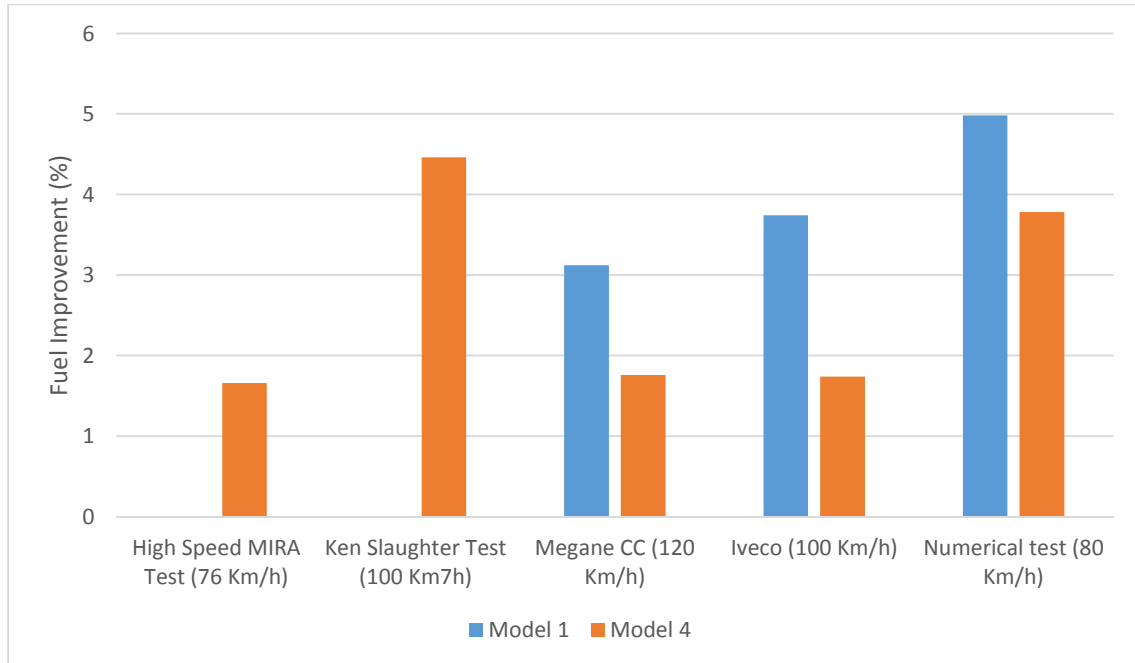

Fig. 11: Resume of Table I. Improvement (%) of fuel consumption for all cases,

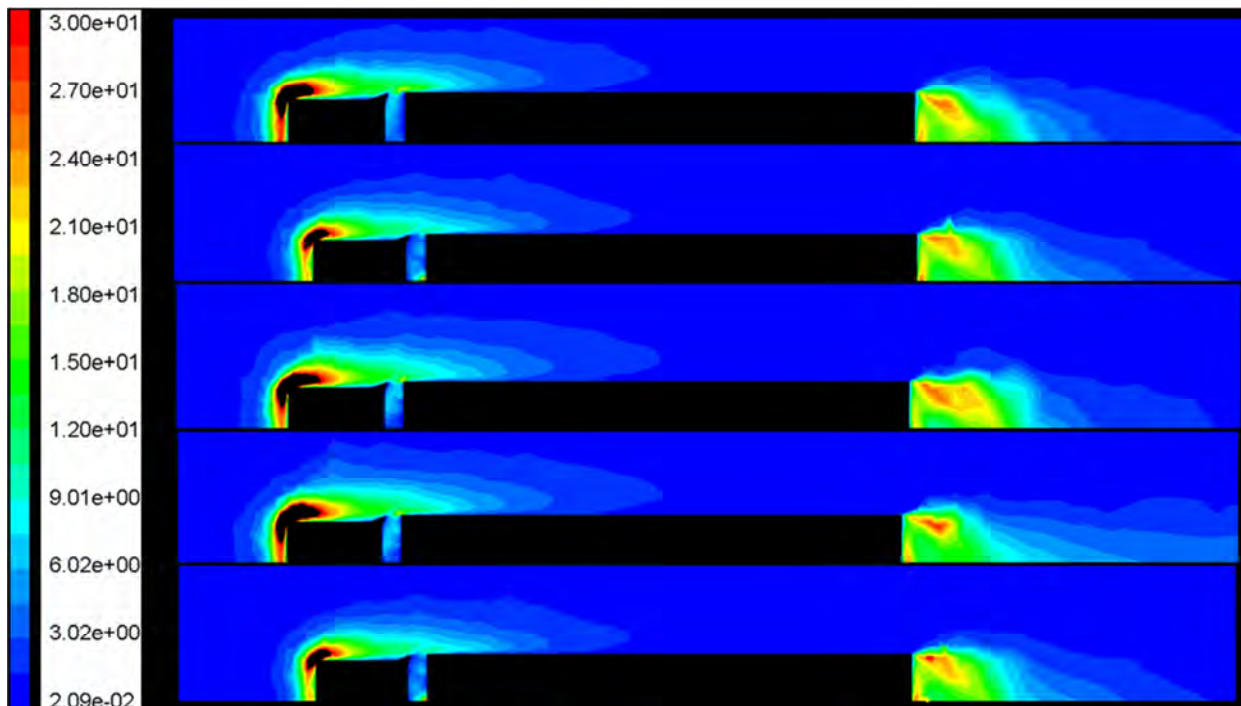

Fig 11: Turbulent energy (J) for a vertical plane in the zone of the lateral VGs. Original (top), model 1, model 2, model 3 and model 4 (bottom)