

M<sup>a</sup> Aranzazu Mendivil Uceda

Alfajar assaraqusti:  
Cerámica andalusí en el  
Teatro romano de  
Zaragoza  
Anexo II

Director/es

Magallón Botaya, María de los Ángeles

<http://zaguan.unizar.es/collection/Tesis>





**Universidad**  
Zaragoza

Tesis Doctoral

**ALFAJAR ASSARAQUSTI: CERÁMICA ANDALUSÍ  
EN EL TEATRO ROMANO DE ZARAGOZA  
ANEXO II**

Autor

**M<sup>a</sup> Aranzazu Mendivil Uceda**

Director/es

Magallón Botaya, María de los Ángeles

**UNIVERSIDAD DE ZARAGOZA  
Escuela de Doctorado**

Programa de Doctorado en Ciencias de la Antigüedad

2019





**Universidad**  
Zaragoza

## Tesis Doctoral

*Alfajār assaraqustī*: Cerámica andalusí en el Teatro romano de Zaragoza

Autora

M.<sup>a</sup> Aránzazu Mendivil Uceda

Directora

M.<sup>a</sup> Ángeles Magallón Botaya

ANEXO II: Láminas

Facultad de Filosofía y Letras de la Universidad de Zaragoza

Departamento de Ciencias de la Antigüedad

2018

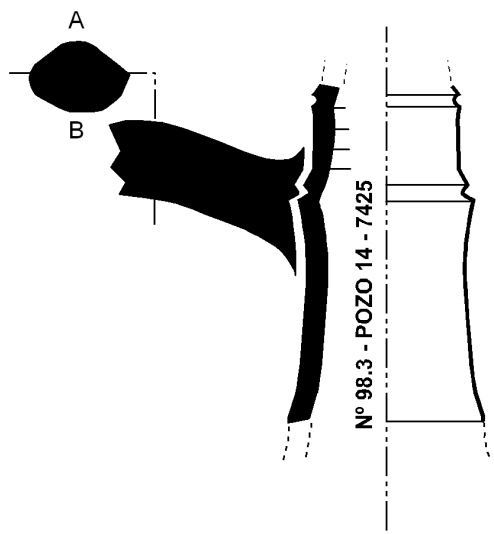
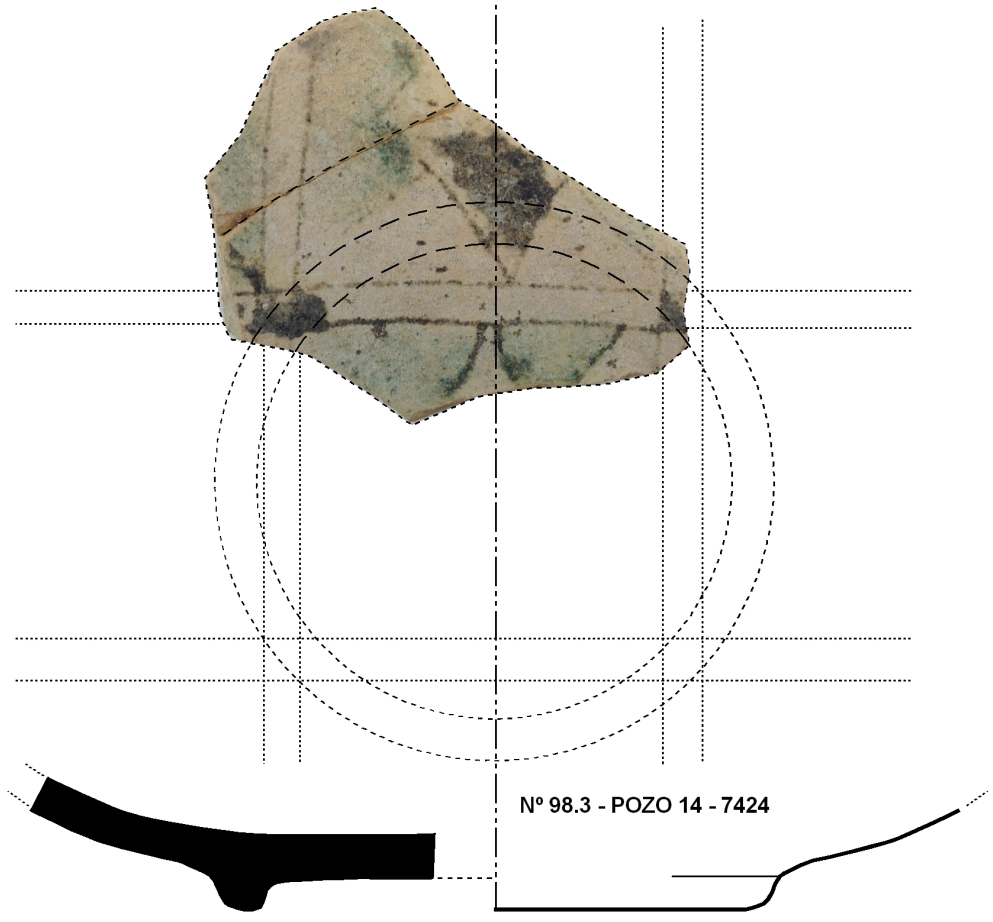

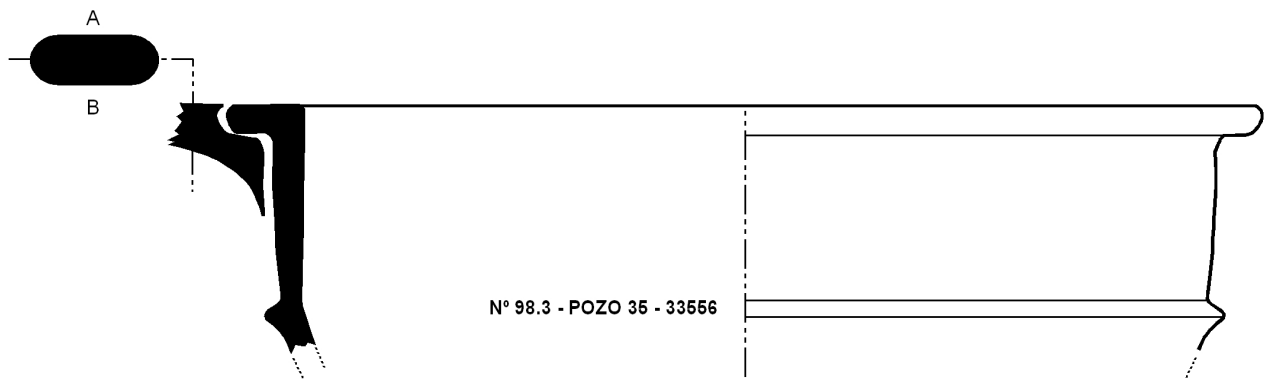
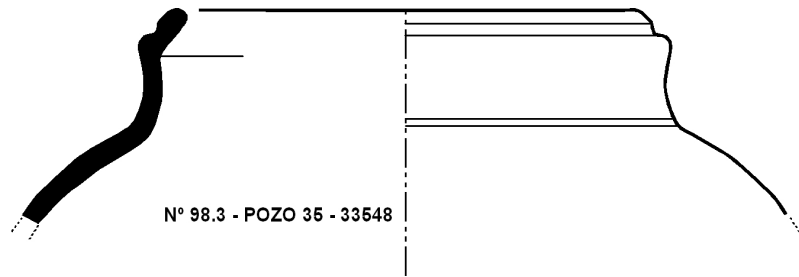
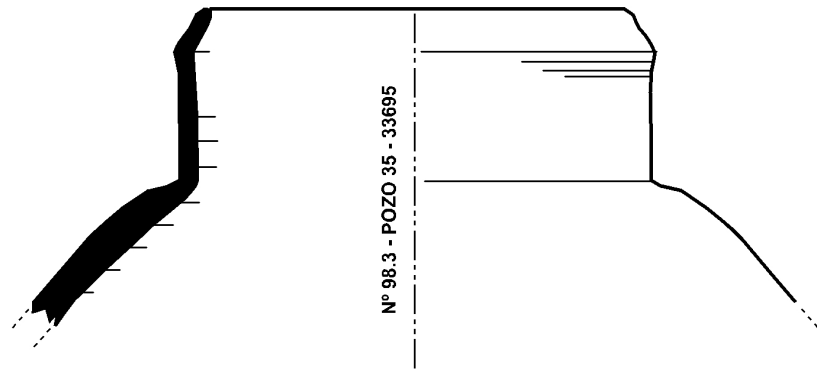



LÁMINA POZO 38

ESCALA: 5 cm.





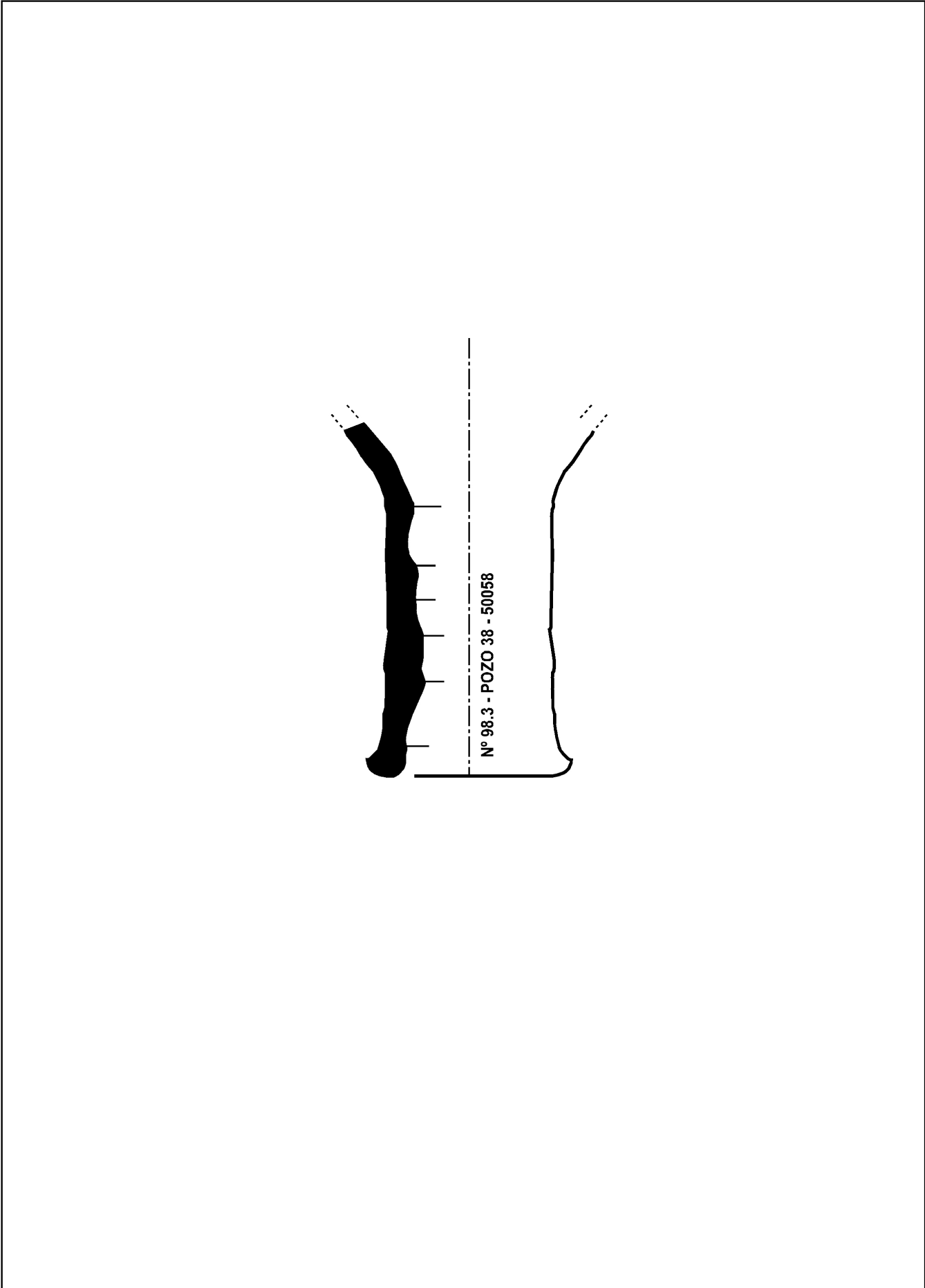

LÁMINA POZO 42

ESCALA: 5 cm.



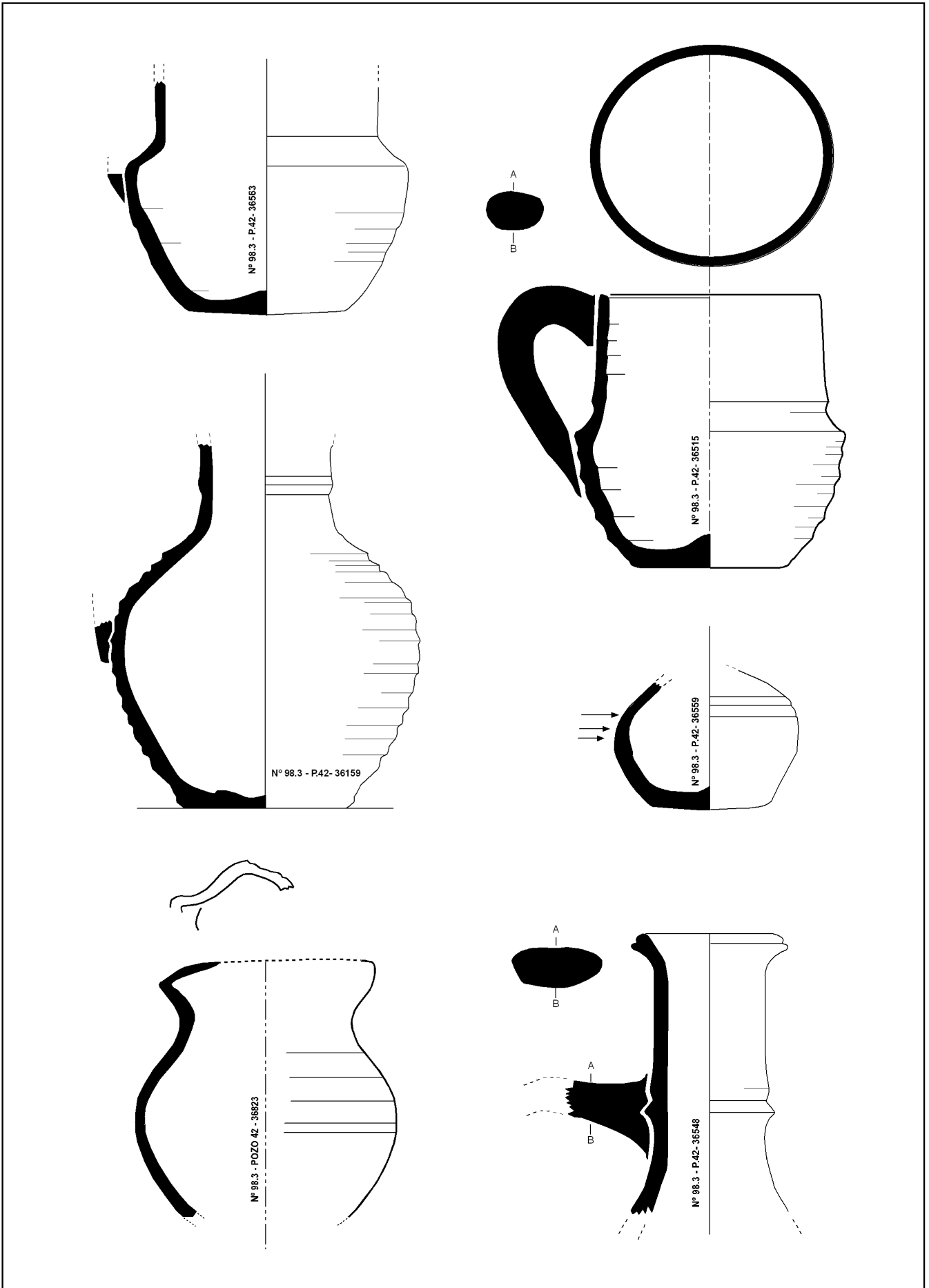
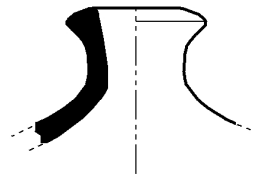
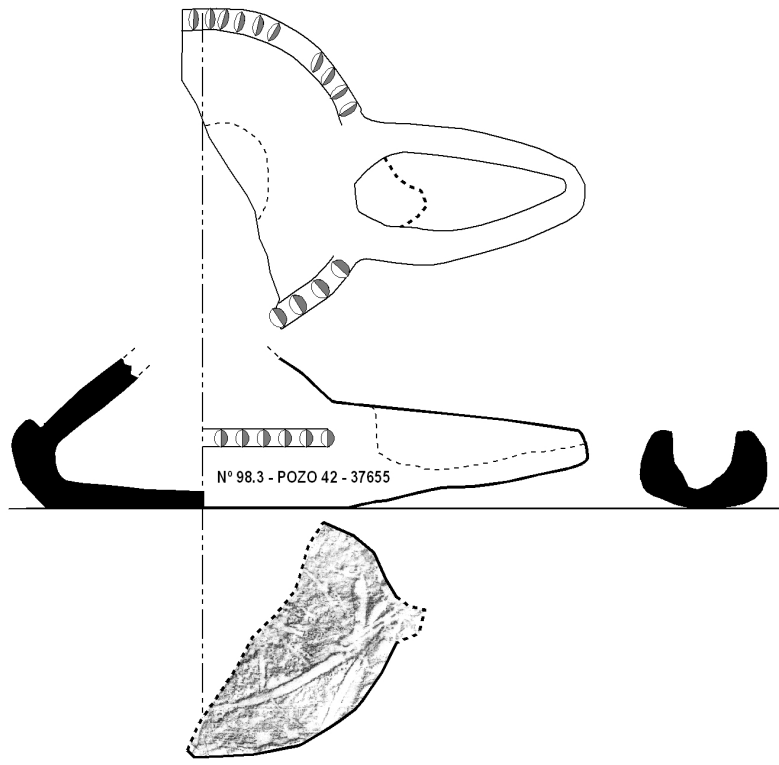

Nº 98.3 - POZO 42 - 37250

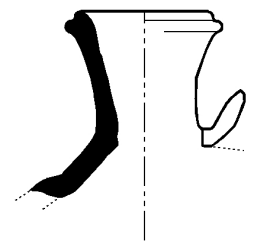

Nº 98.3 - POZO 42 - 36903



Nº 98.3 - POZO 42 - 36908

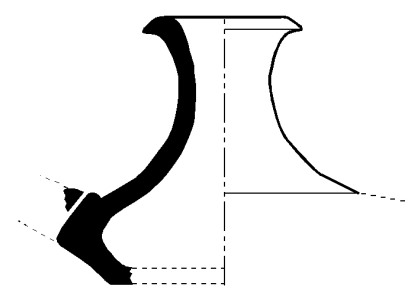

Nº 98.3 - POZO 42 - 36904

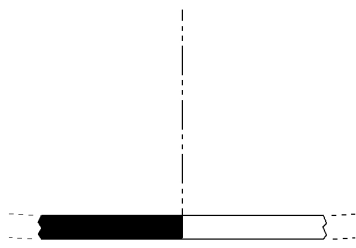

Nº 98.3 - POZO 42 - 37613

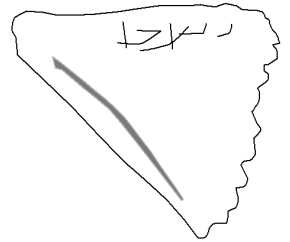
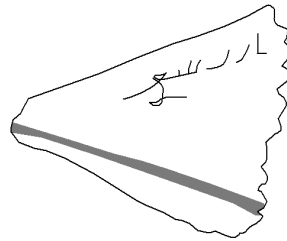
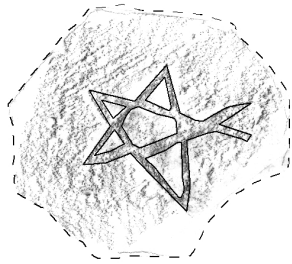

Nº 98.3 - P-42 - 36926

huella  
asa

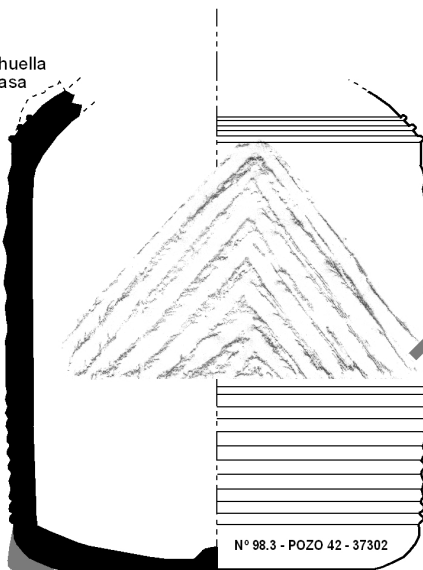

Nº 98.3 - POZO 42 - 37302

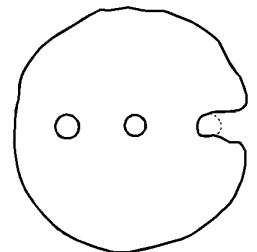

Nº 98.3 - POZO 42 - 37661

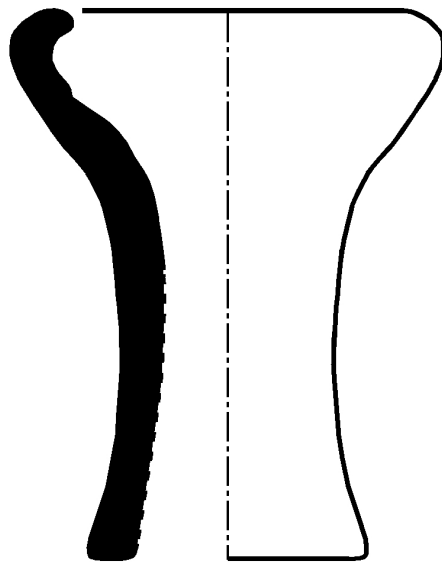

Nº 98.3 - POZO 52 - 42026

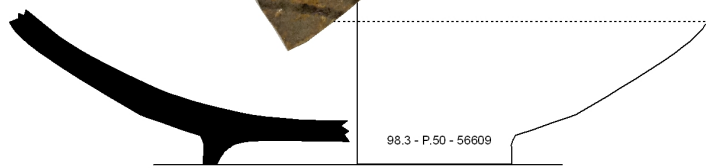
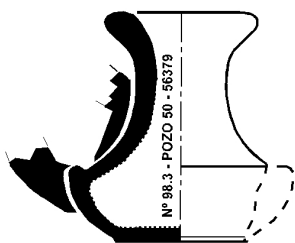
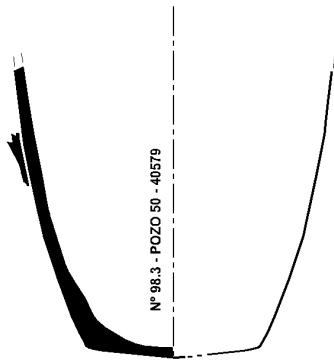
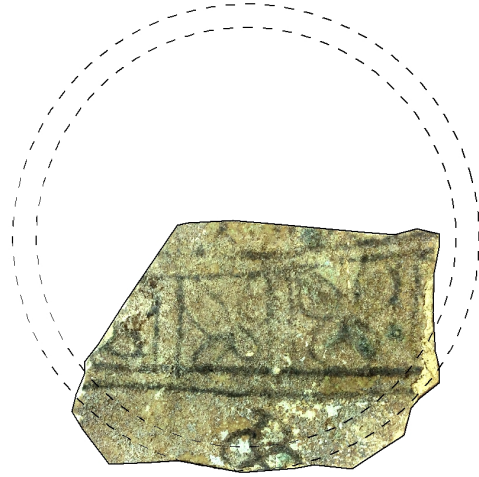
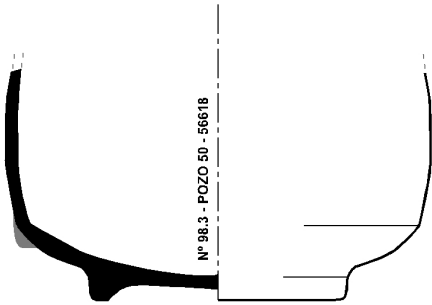

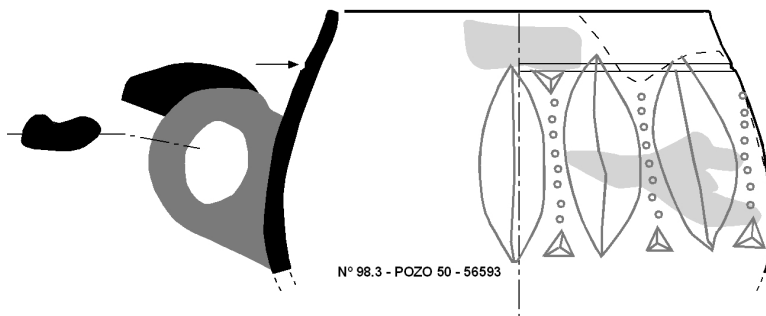
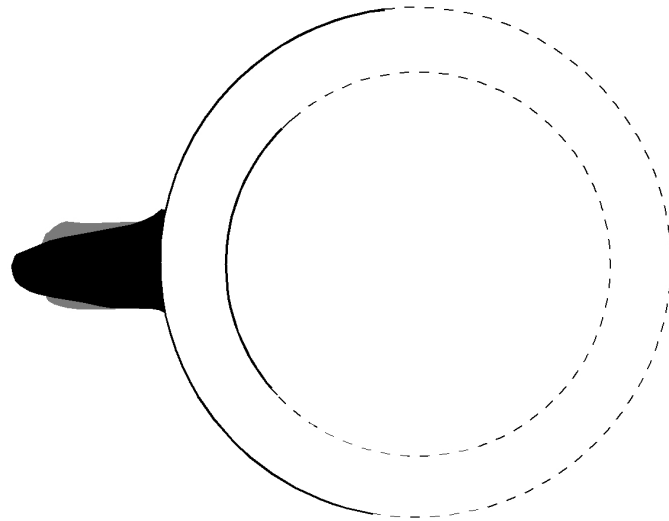
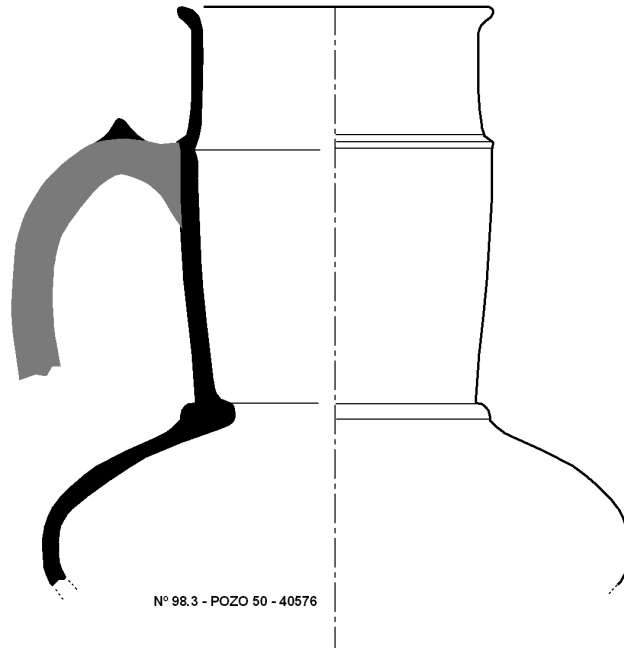

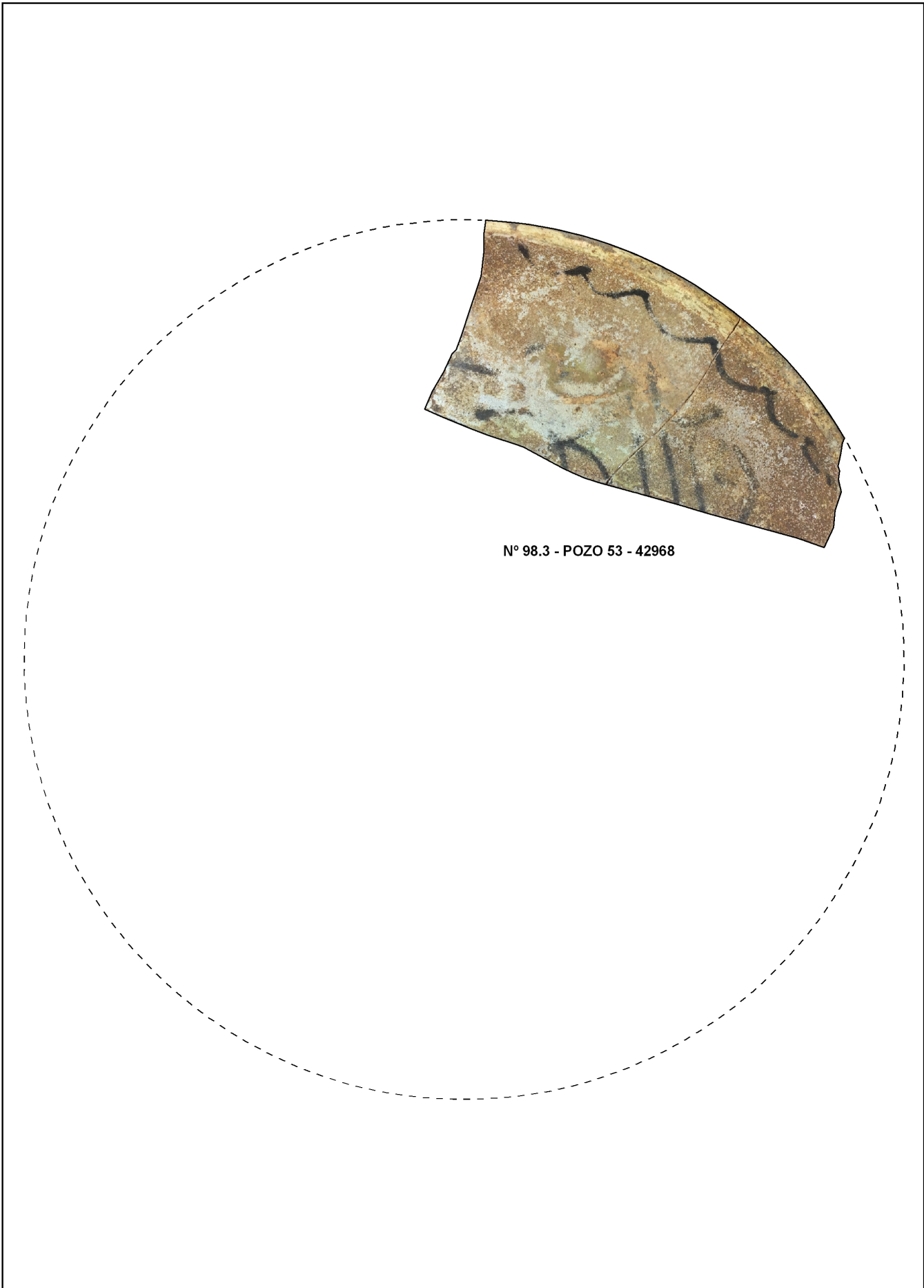

Nº 98.3 - POZO 53 - 42968

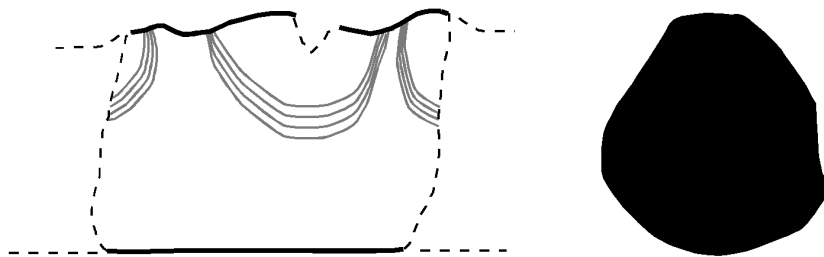

Nº 98.3 - POZO 55 - 45082



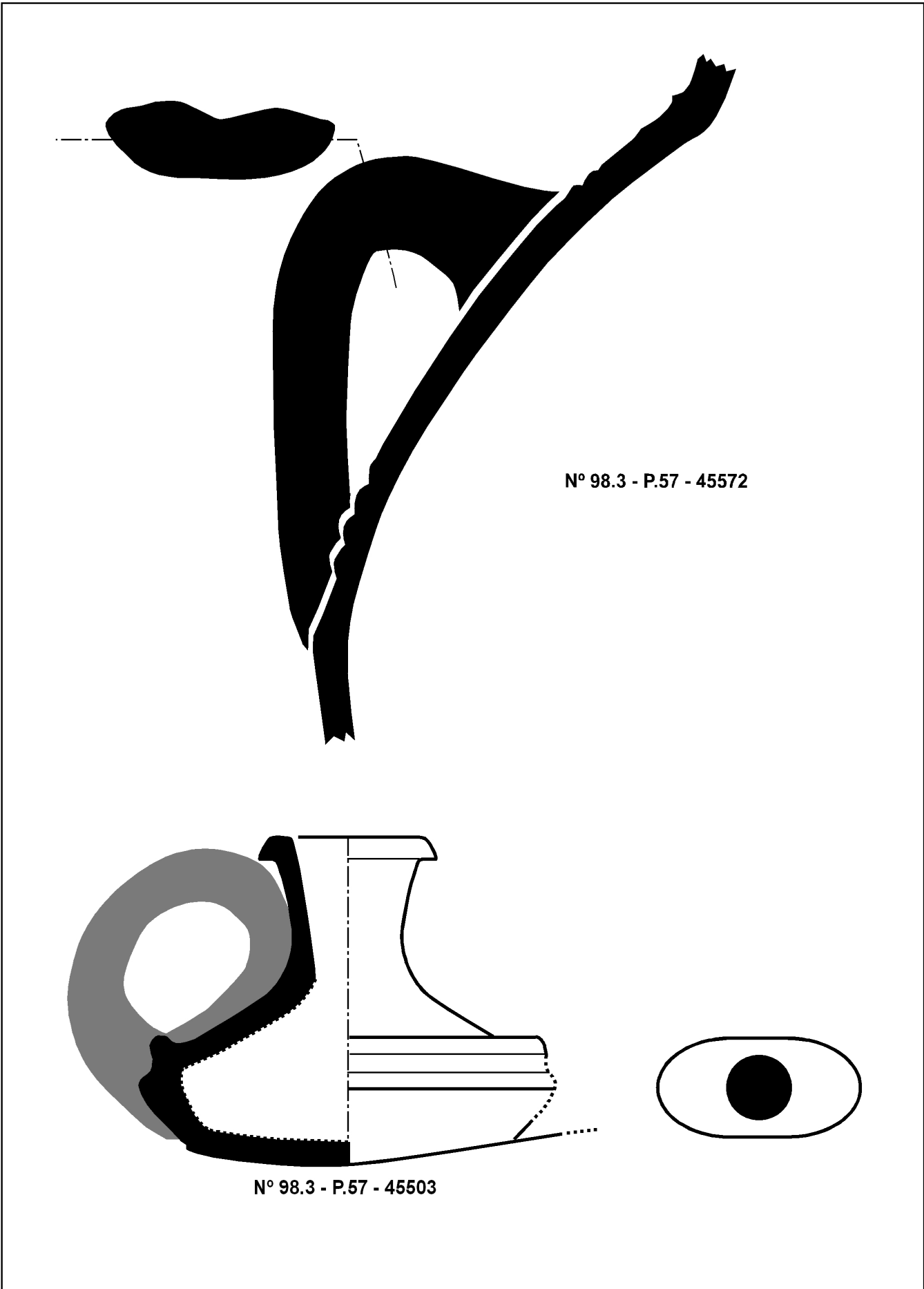

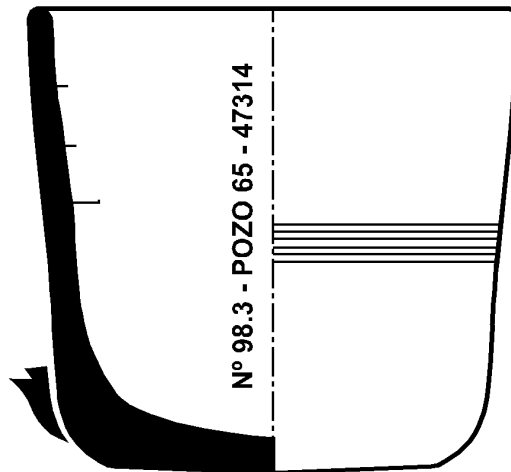



LÁMINA POZO 70

ESCALA: 5 cm.



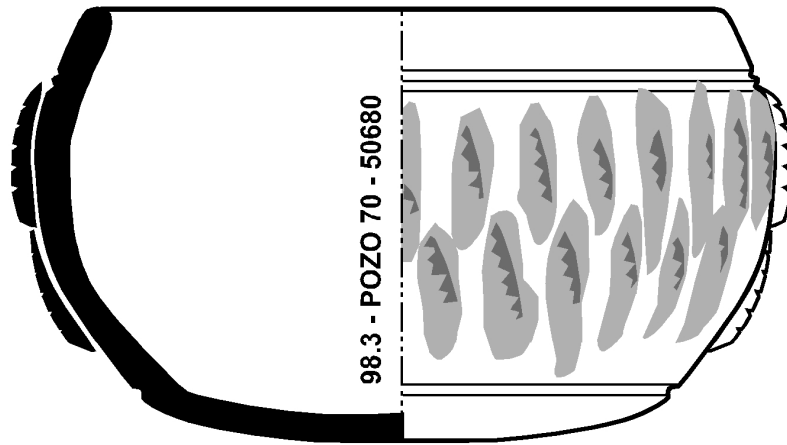
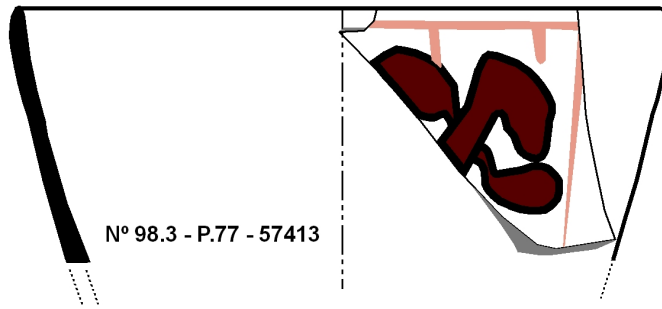

Nº 98.3 - P.77 - 57413

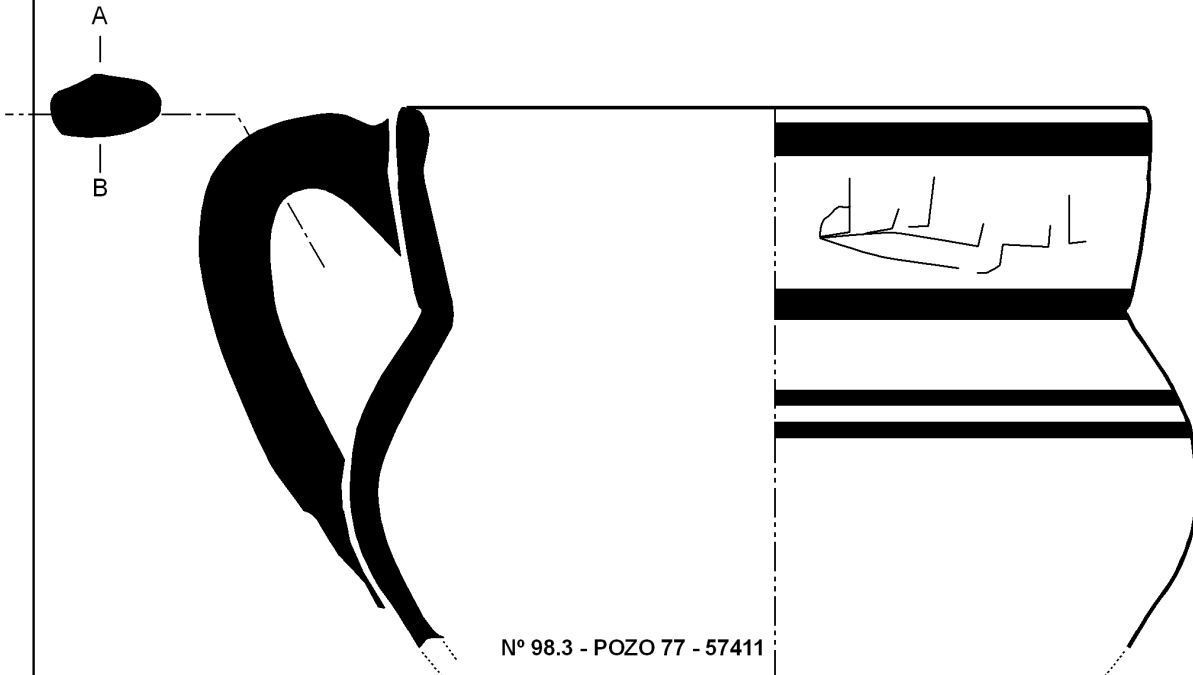

Nº 98.3 - POZO 77 - 57411

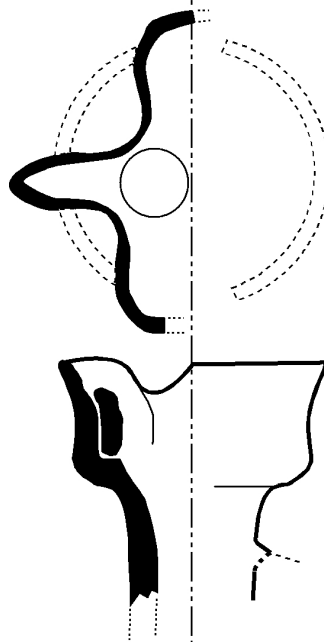

Nº 98.3 - POZO 77 - 57438

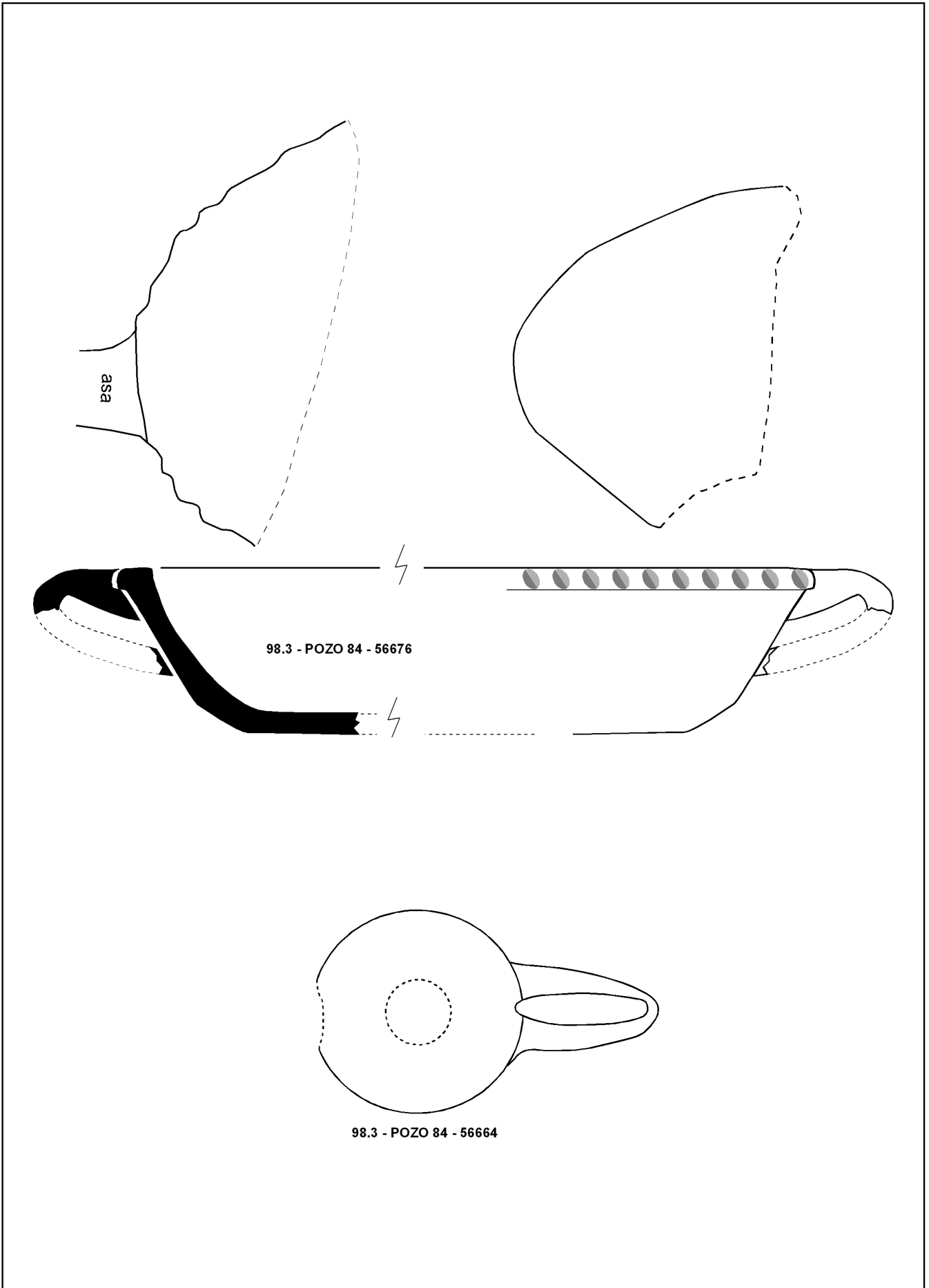

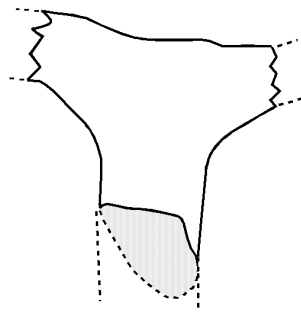

98.3 - POZO 86 - 58070

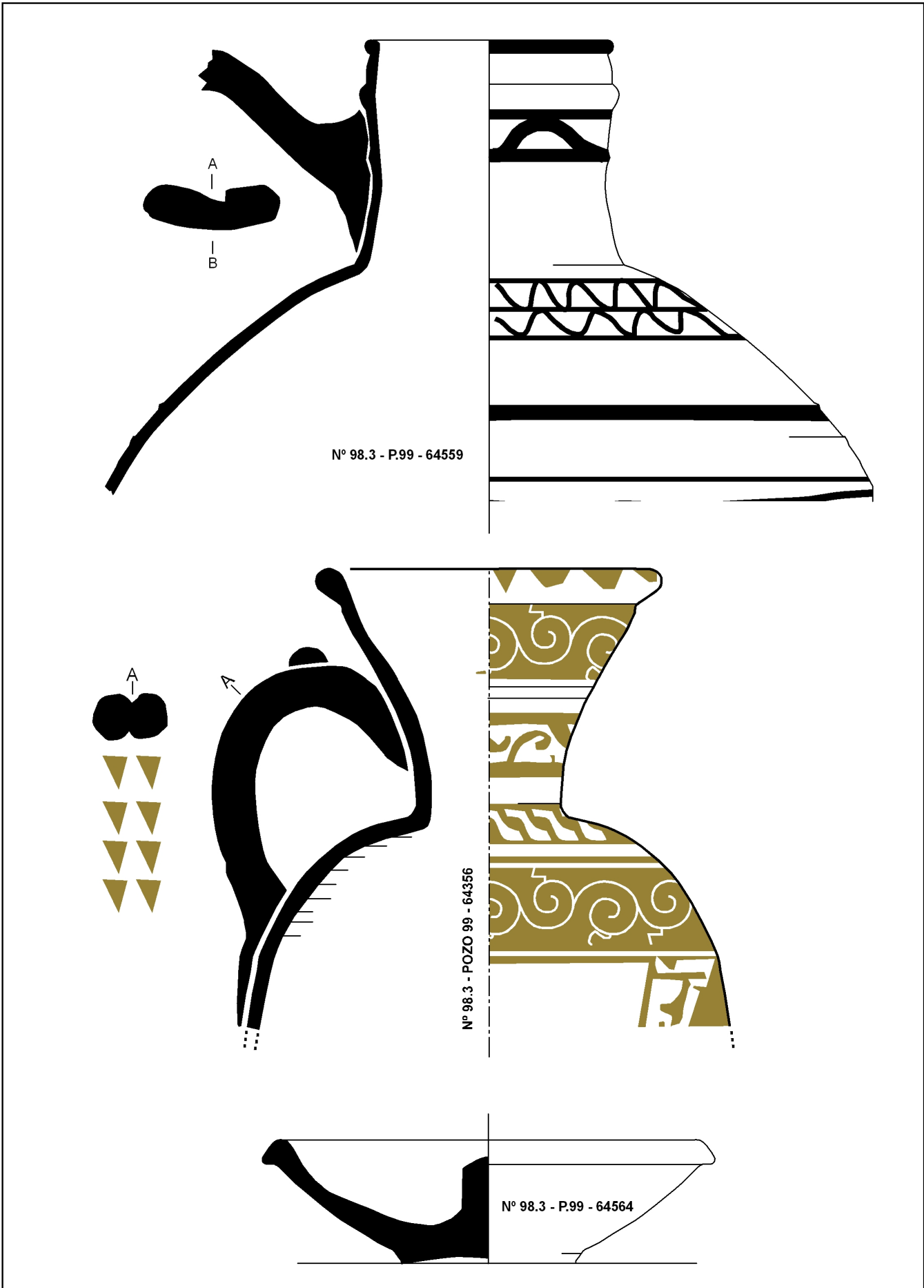

Nº 98.3 - P.99 - 64559

Nº 98.3 - POZO 99 - 64356

Nº 98.3 - P.99 - 64564

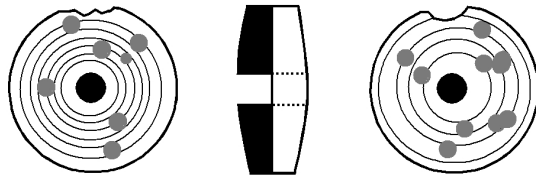

Nº 98.3 - P.100 - 65709



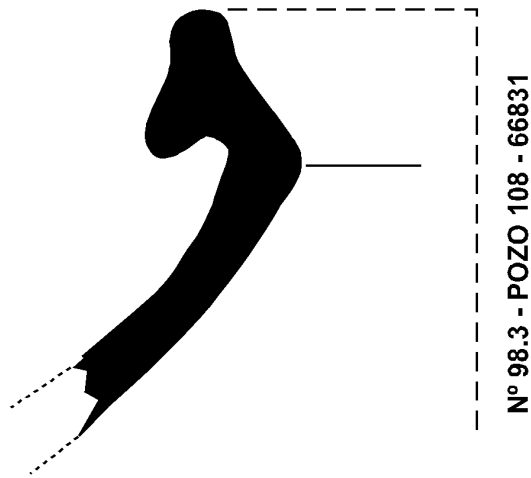

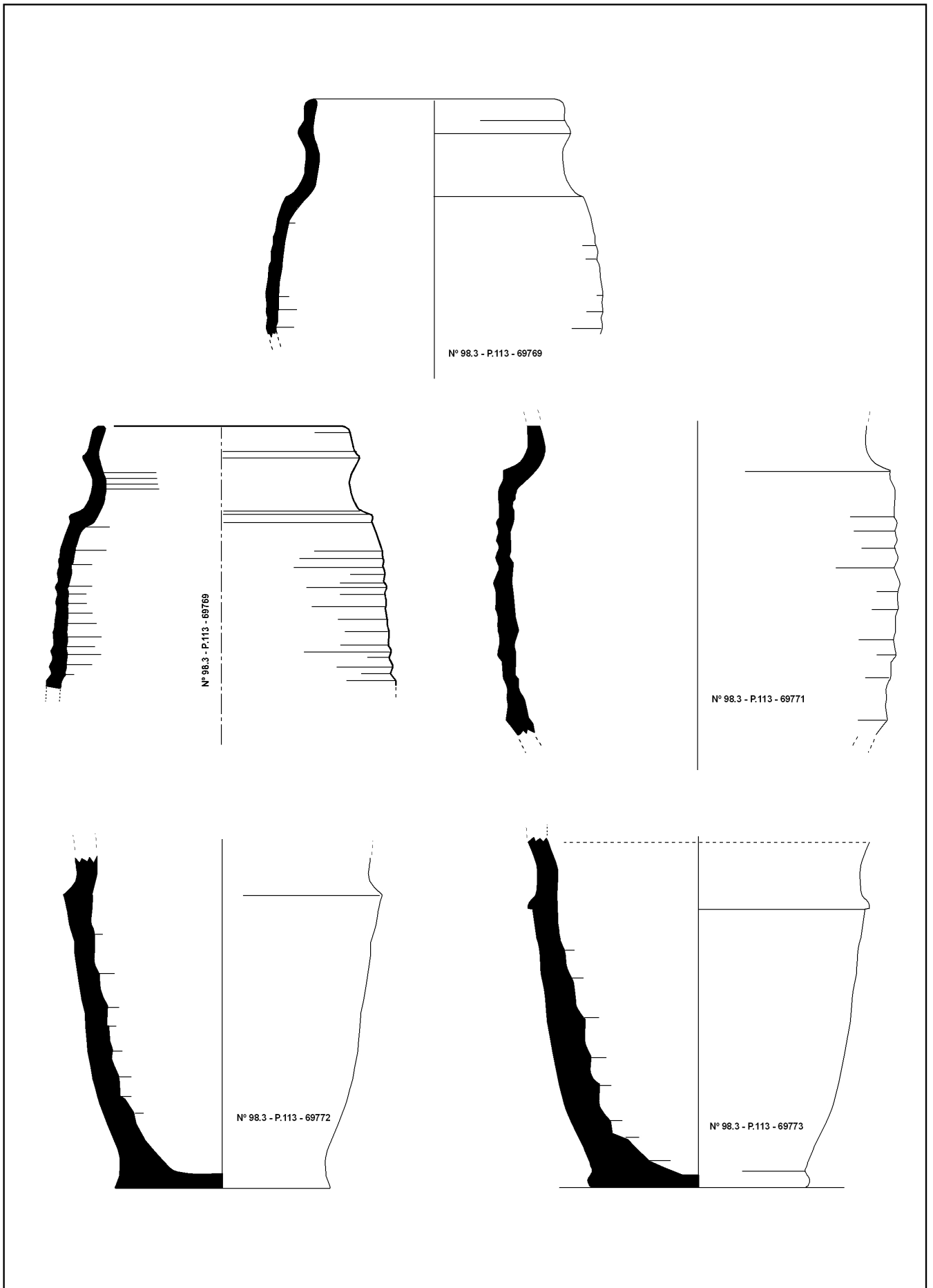

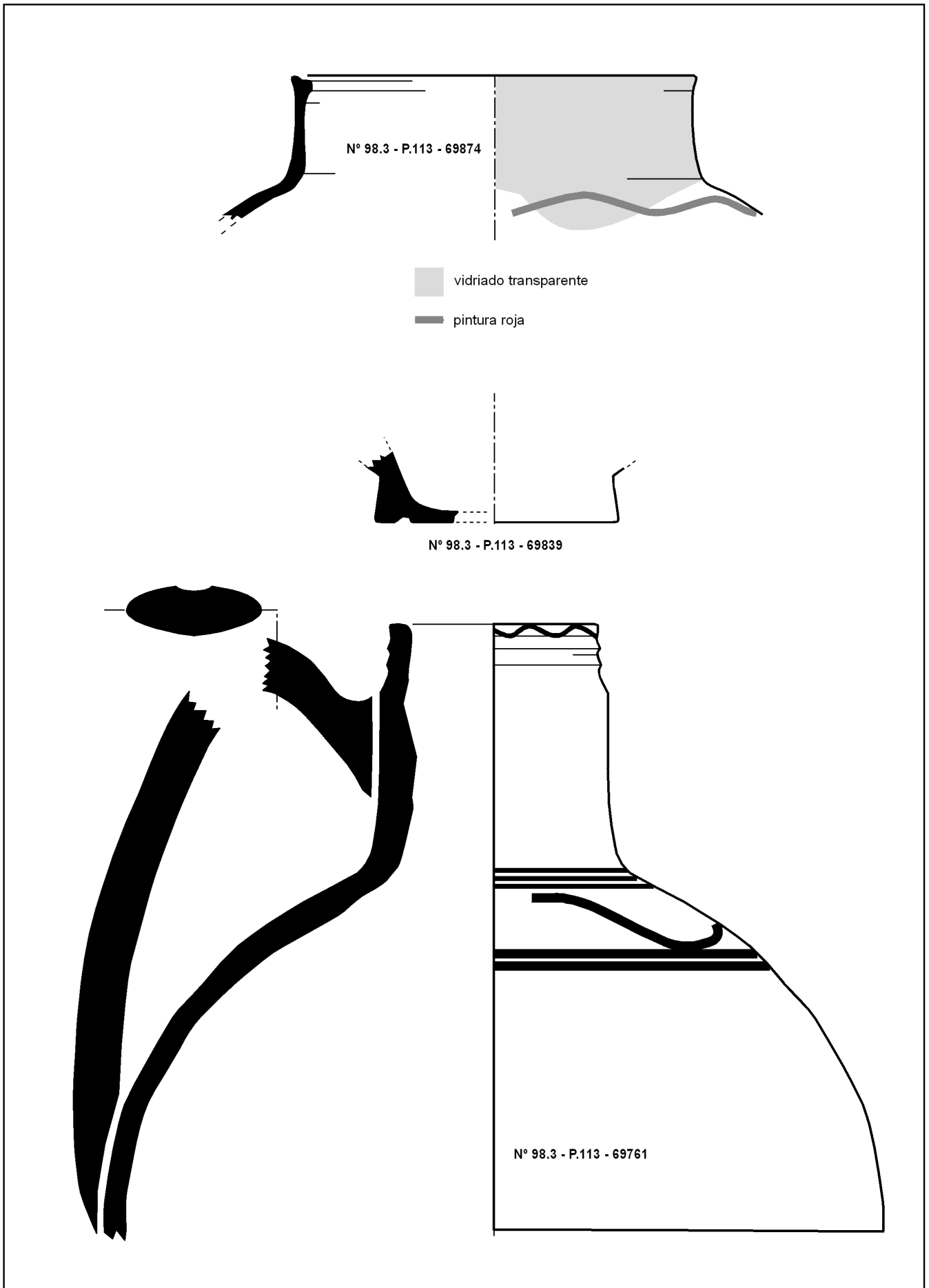

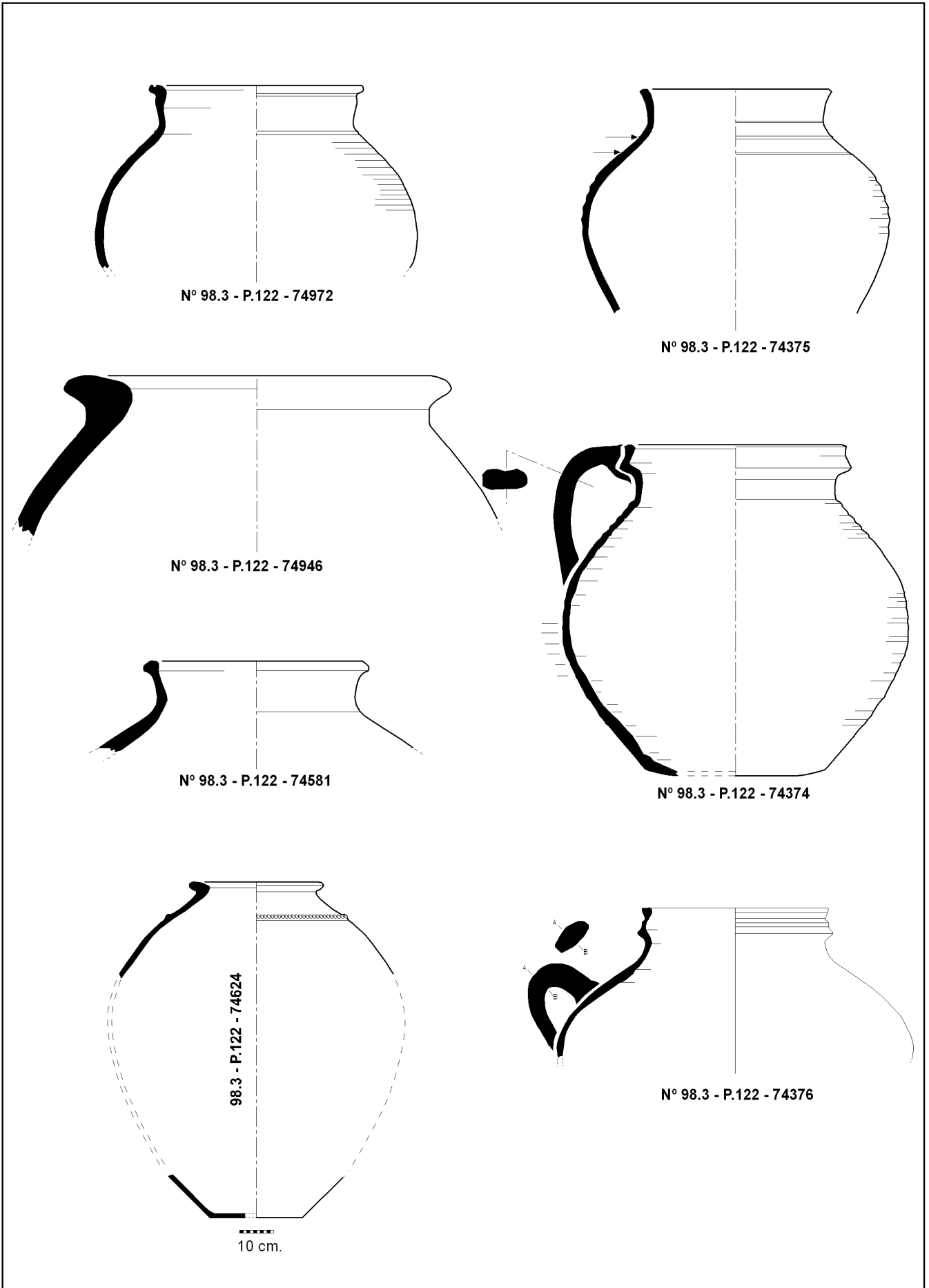

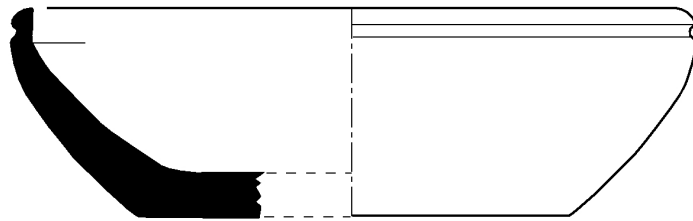

Nº 98.3 - P.122 - 74558

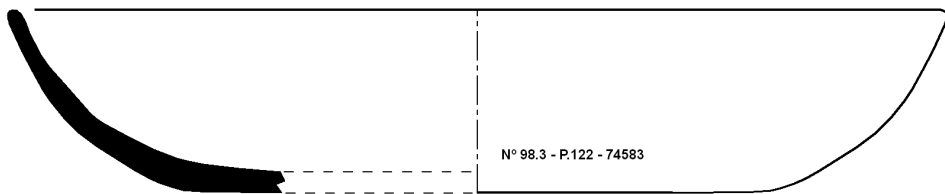

Nº 98.3 - P.122 - 74583

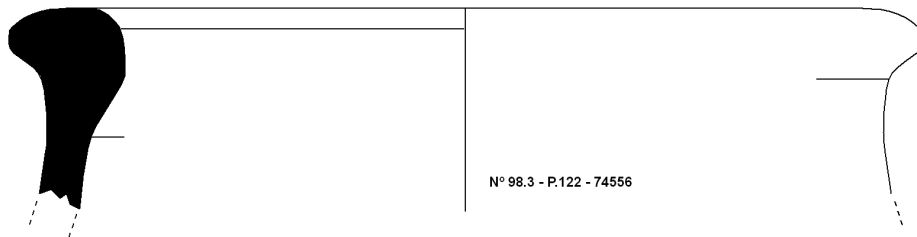

Nº 98.3 - P.122 - 74556

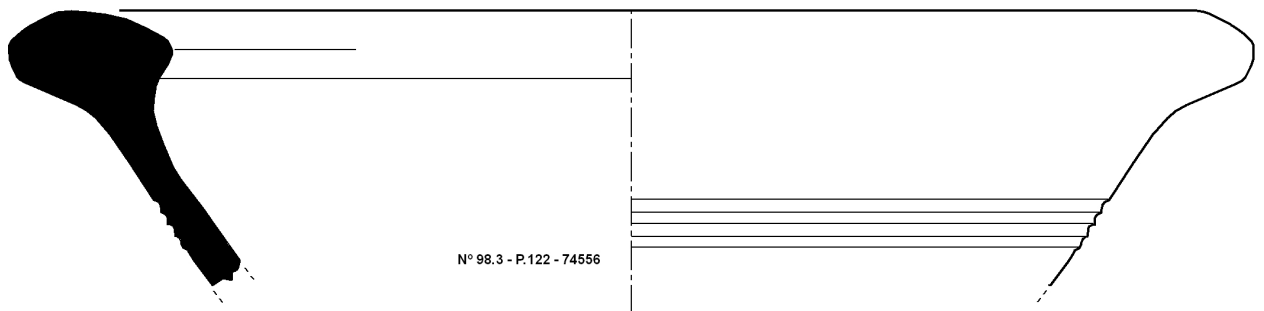

Nº 98.3 - P.122 - 74556

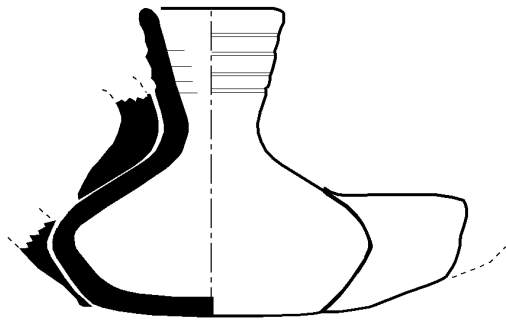
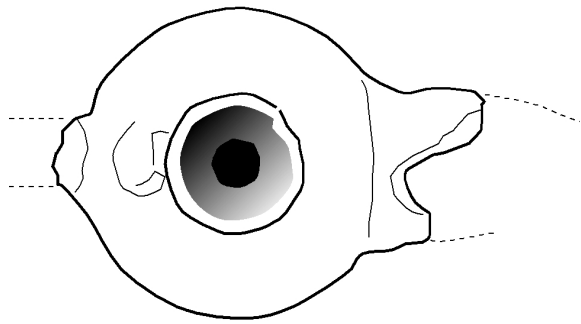

Nº 98.3 - P.122 - 74616

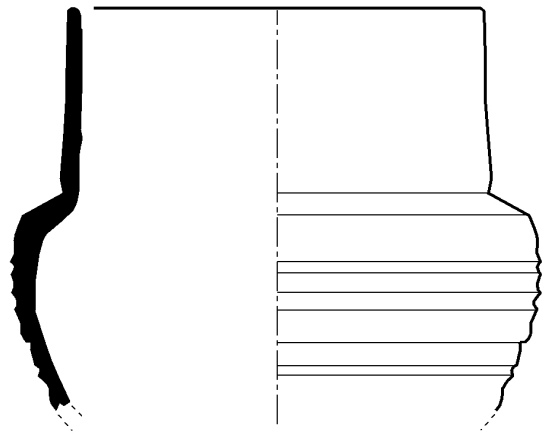

Nº 98.3 - P.122 - 74549

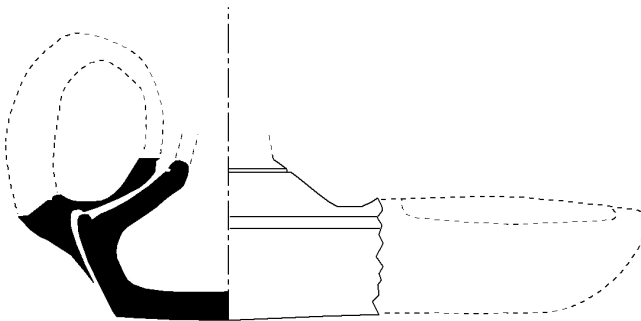

Nº 98.3 - P.122 - 74371

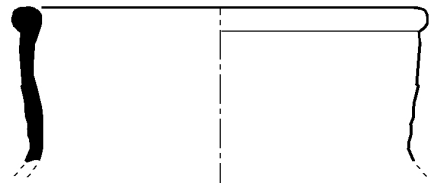

Nº 98.3 - P.122 - 74377

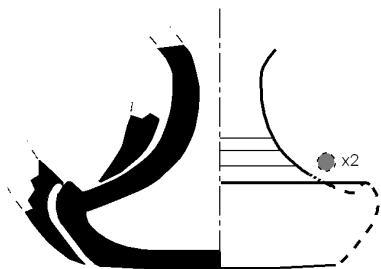

Nº 98.3 - POZO 122 - 74372

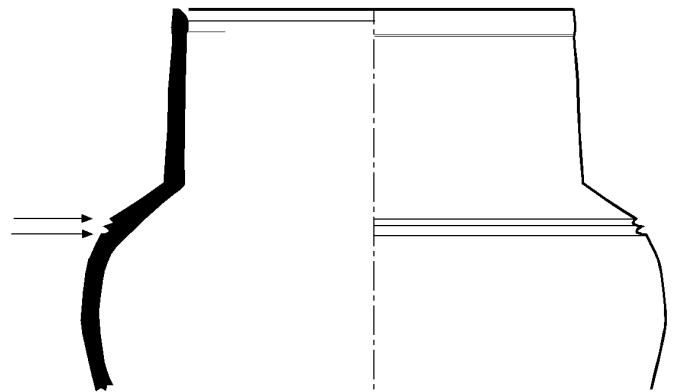

Nº 98.3 - P.122 - 74551

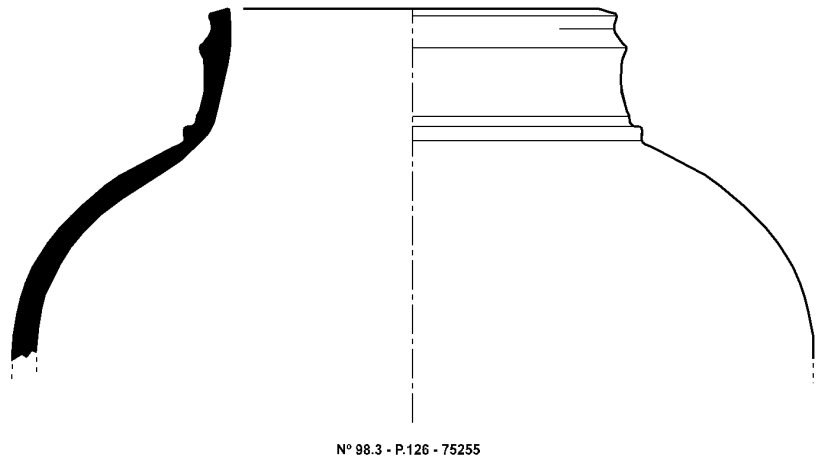
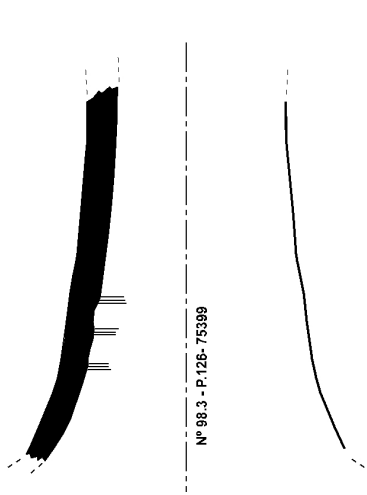
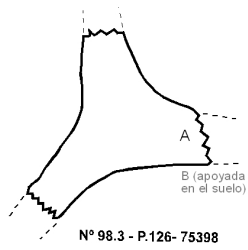

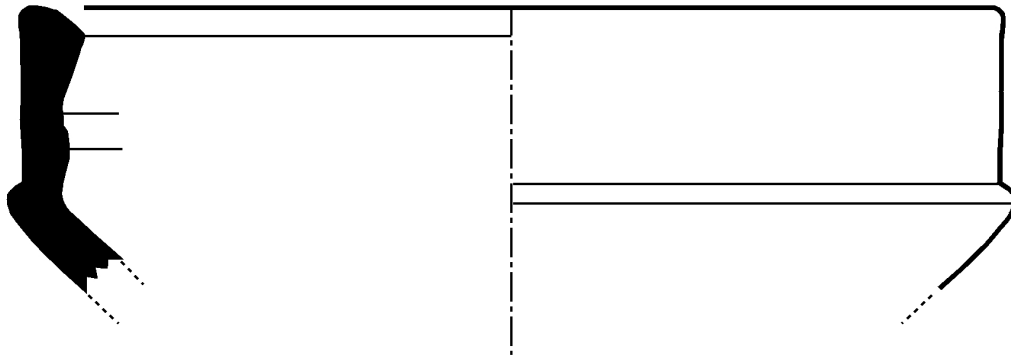

Nº 98.3 - P.129- 88043

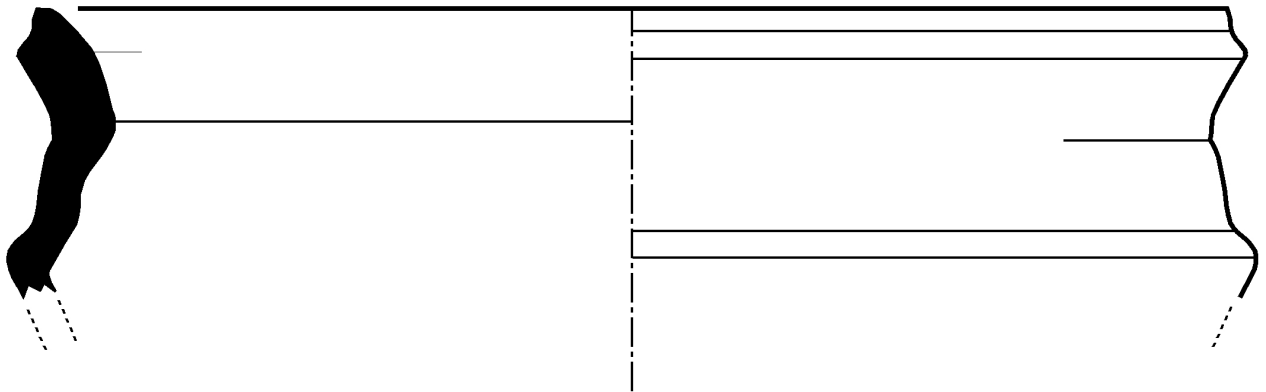

Nº 98.3 - P.129- 88042



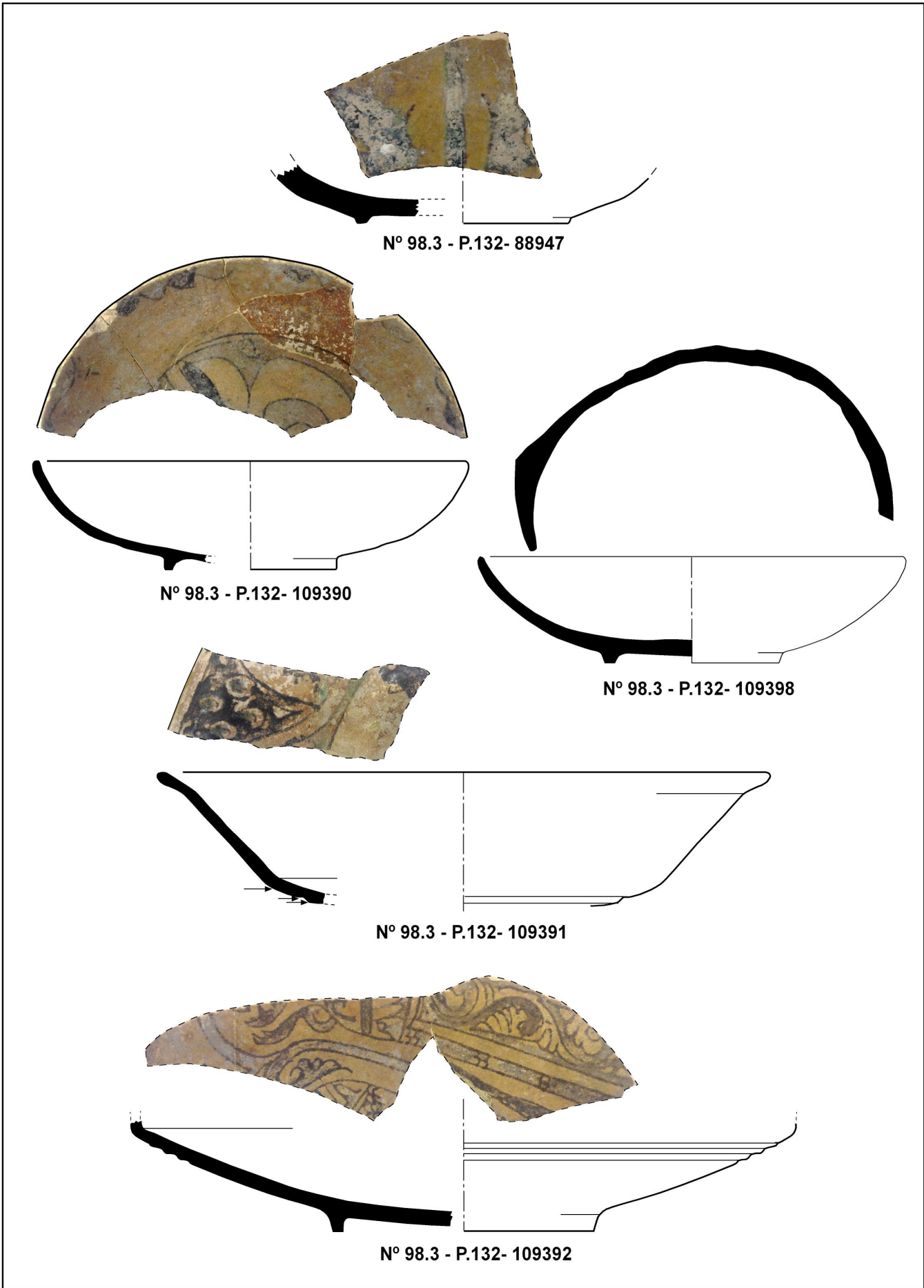

VIDRIOS

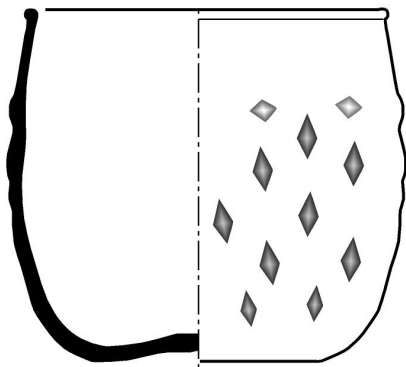

Nº 98.3 - P.132 - 88989

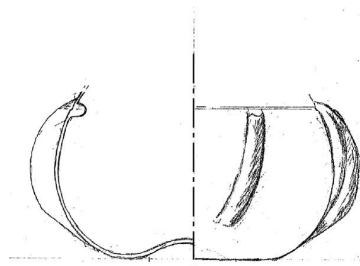

Nº 98.3 - P.132- 109451



Nº 98.3 - P.132- 109259

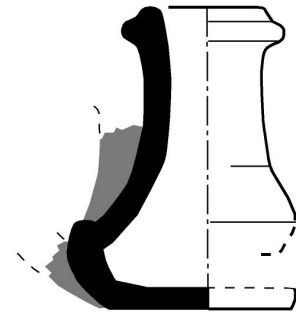

Nº 98.3 - P.132- 109250

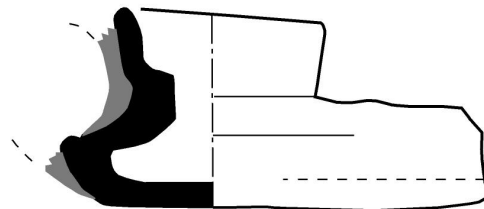
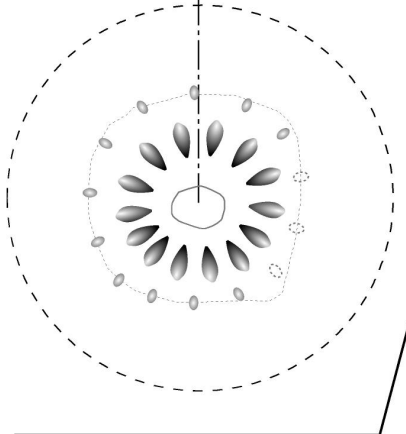

Nº 98.3 - P.132- 109249

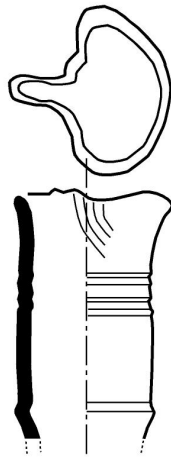

Nº 98.3 - P.132- 109433

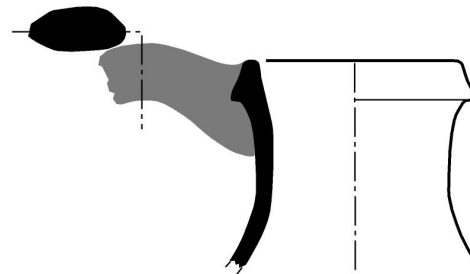

Nº 98.3 - P.132- 109253

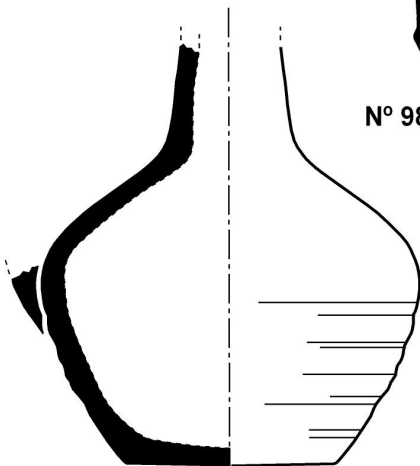

Nº 98.3 - P.132- 109437

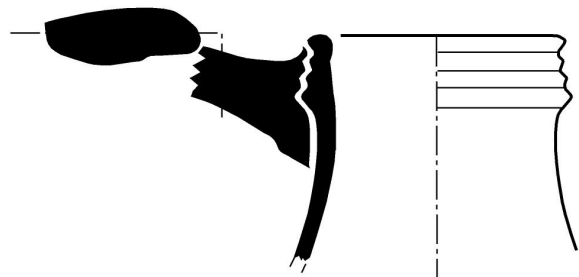

Nº 98.3 - P.132- 109254

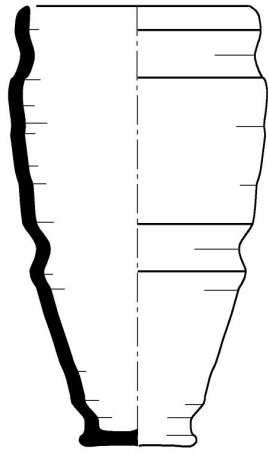

Nº 98.3 - P.132- 91846

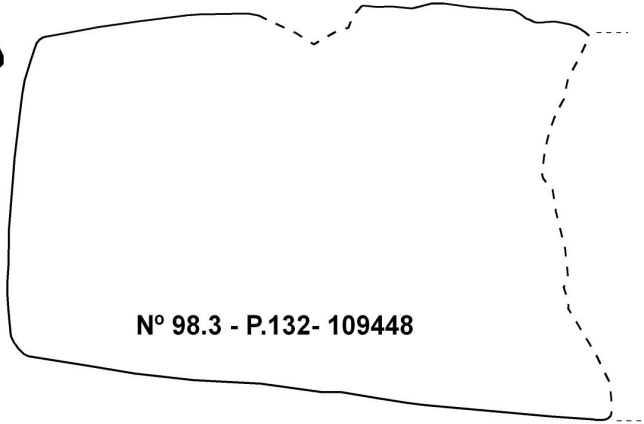
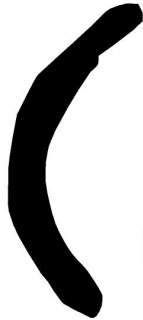

Nº 98.3 - P.132- 109448

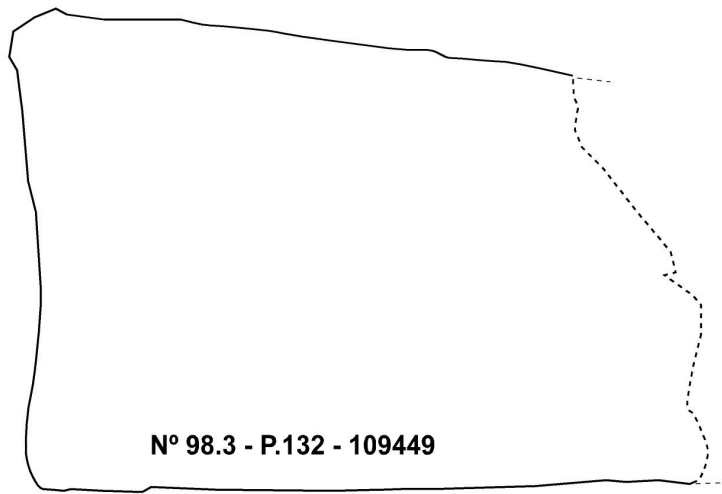
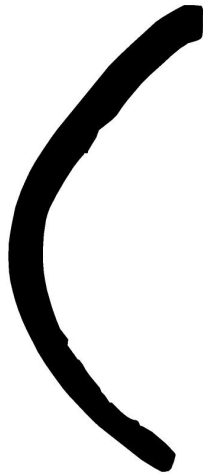

Nº 98.3 - P.132 - 109449

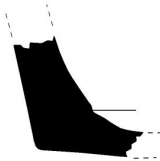

Nº 98.3 - P.132- 91849



Nº 98.3 - P.132- 88935

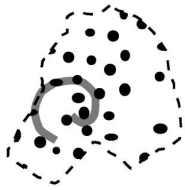

Nº 98.3 - P.133- 95375

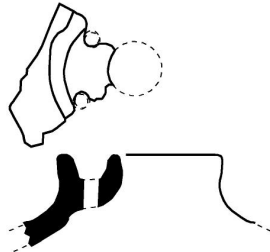

Nº 98.3 - P.133- 95661

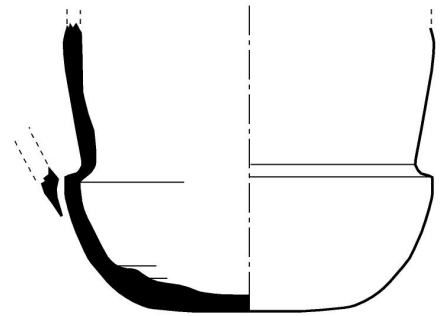

Nº 98.3 - P.133- 95383

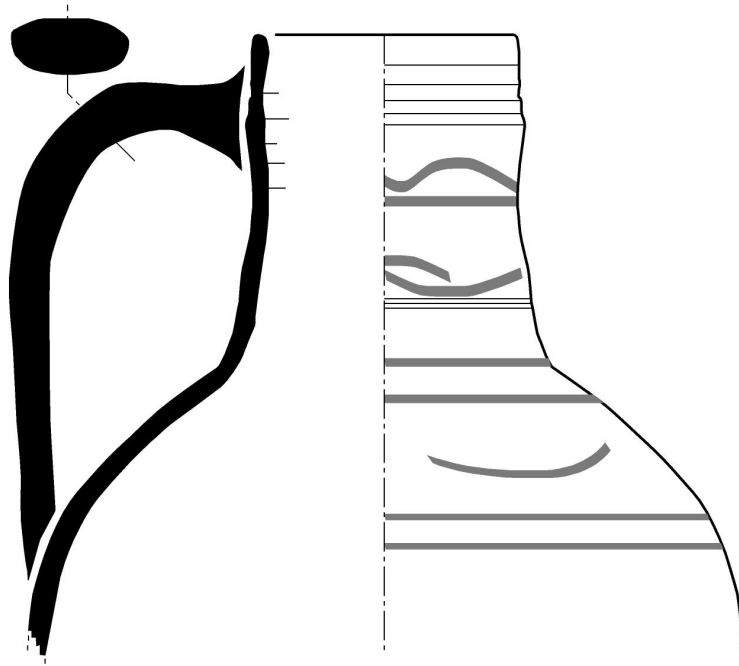

Nº 98.3 - P.133- 95376

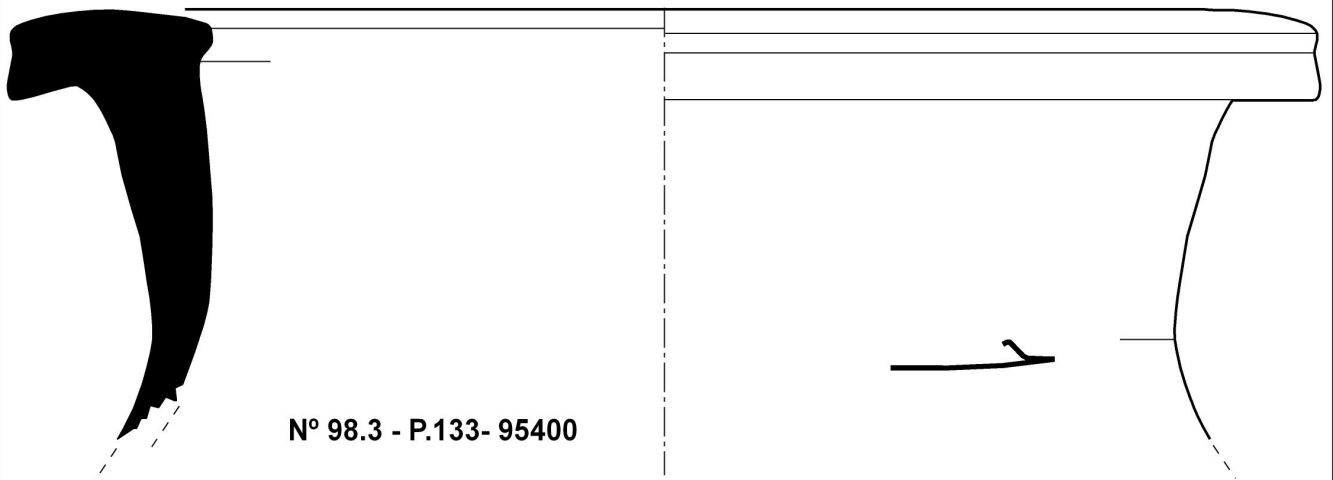

Nº 98.3 - P.133- 95400

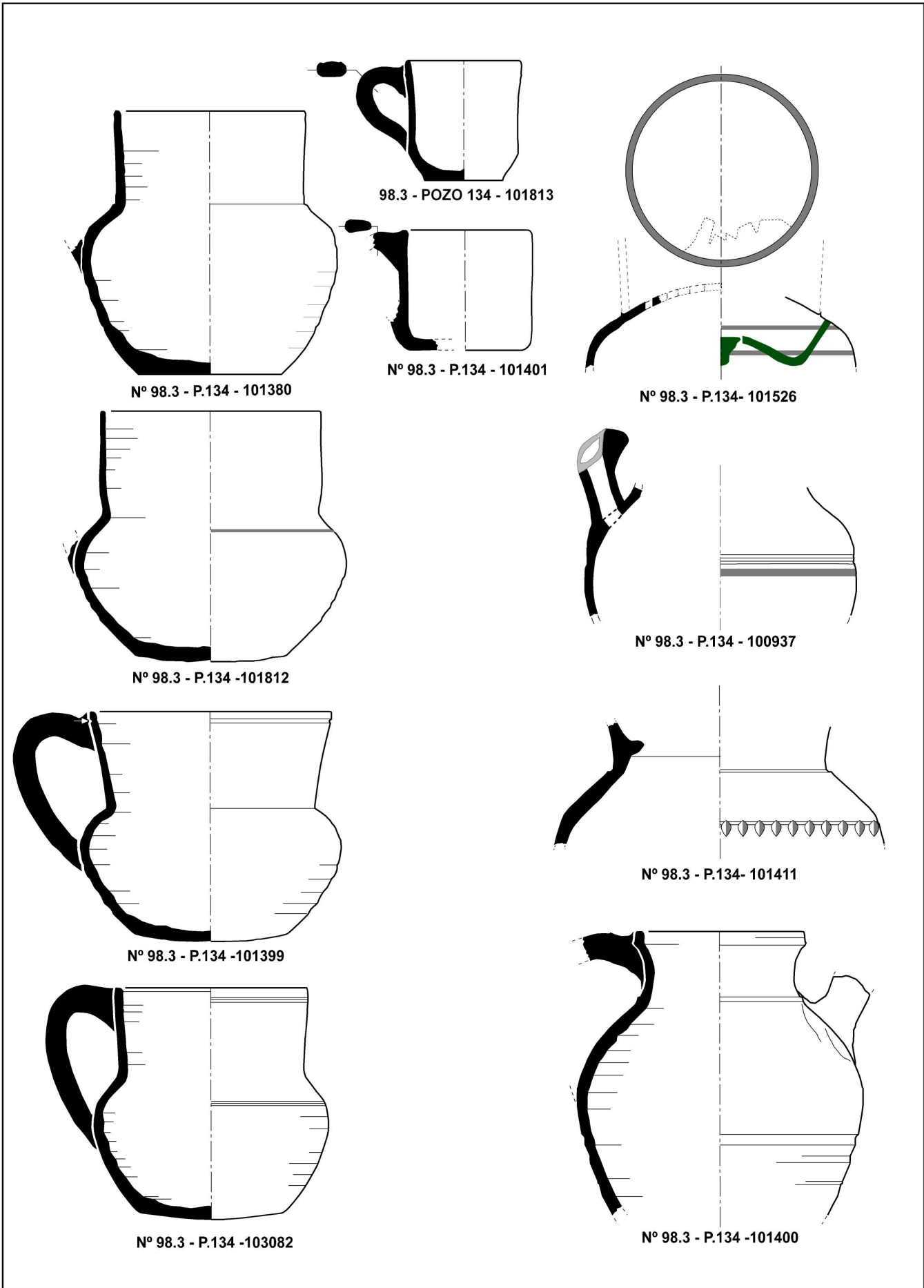

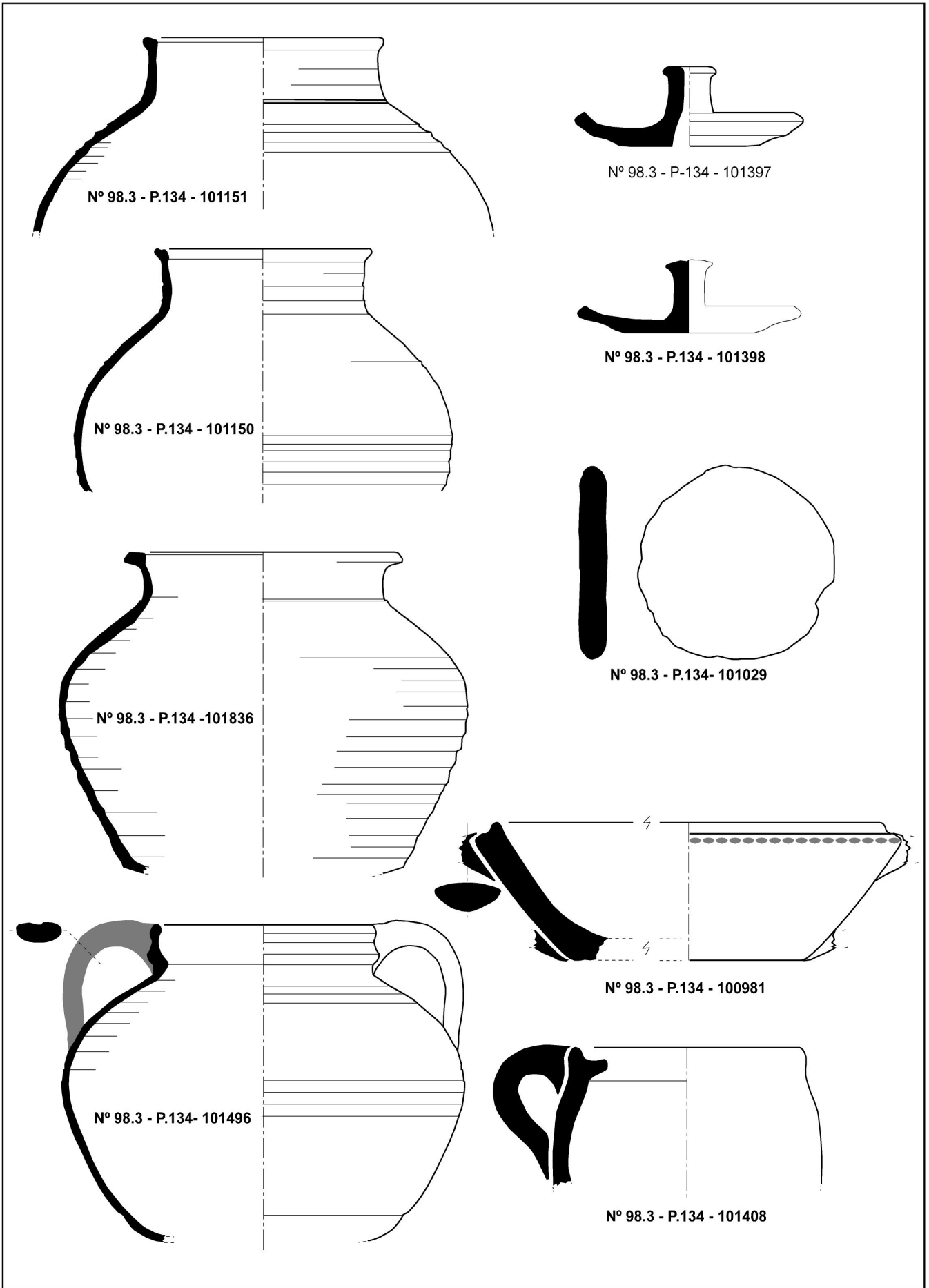

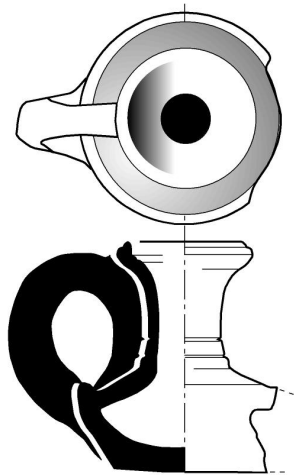

Nº 98.3 - P.134 - 101393

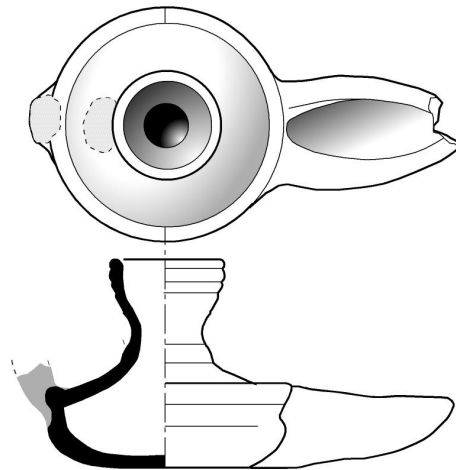

98.3 - POZO 134 - 101392

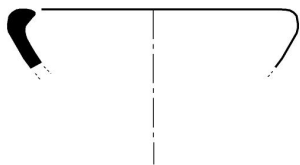

Nº 98.3 - P.134 - 103081

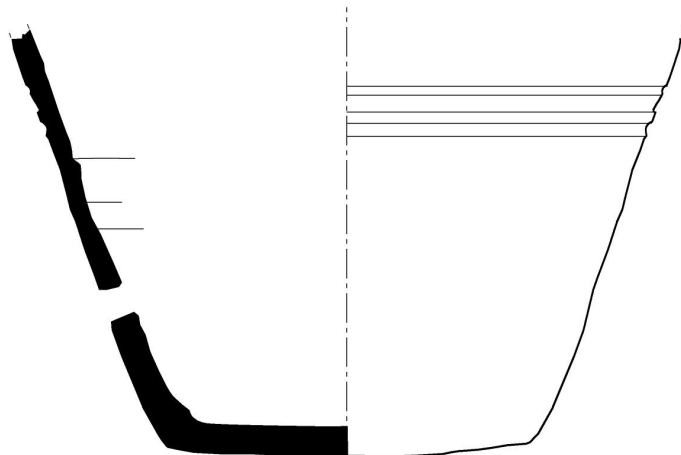

Nº 98.3 - P.134 - 101001

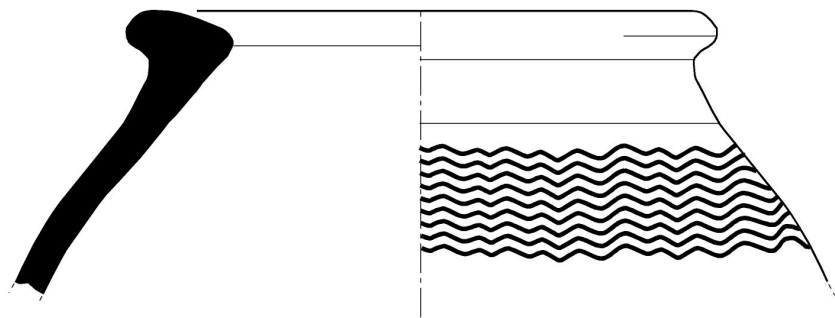

Nº 98.3 - P.134 - 101410

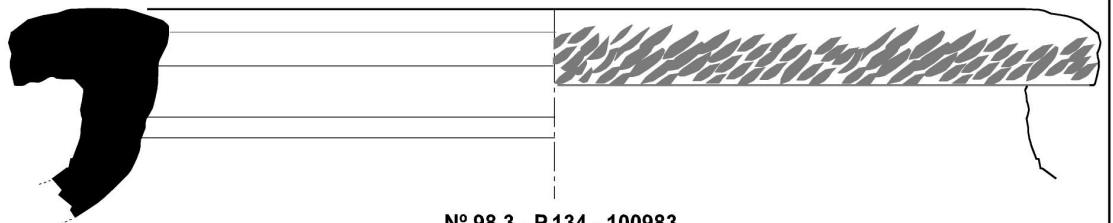

Nº 98.3 - P.134 - 100983

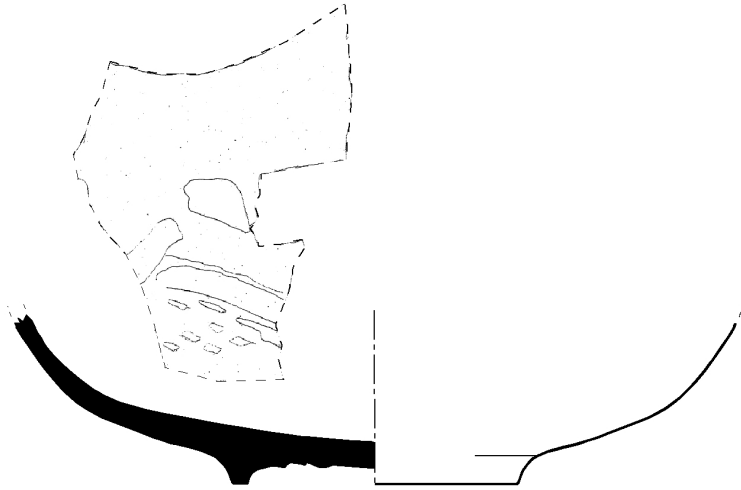

Nº 98.3 - P.151-119098

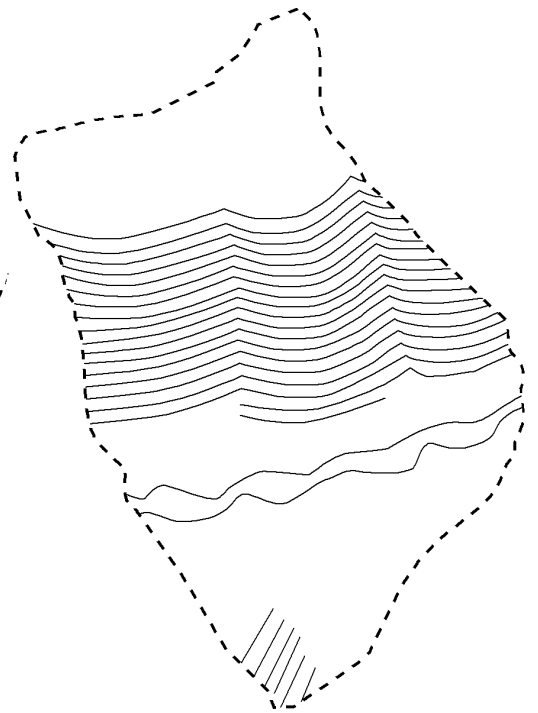

Nº 98.3 - P.151-119113

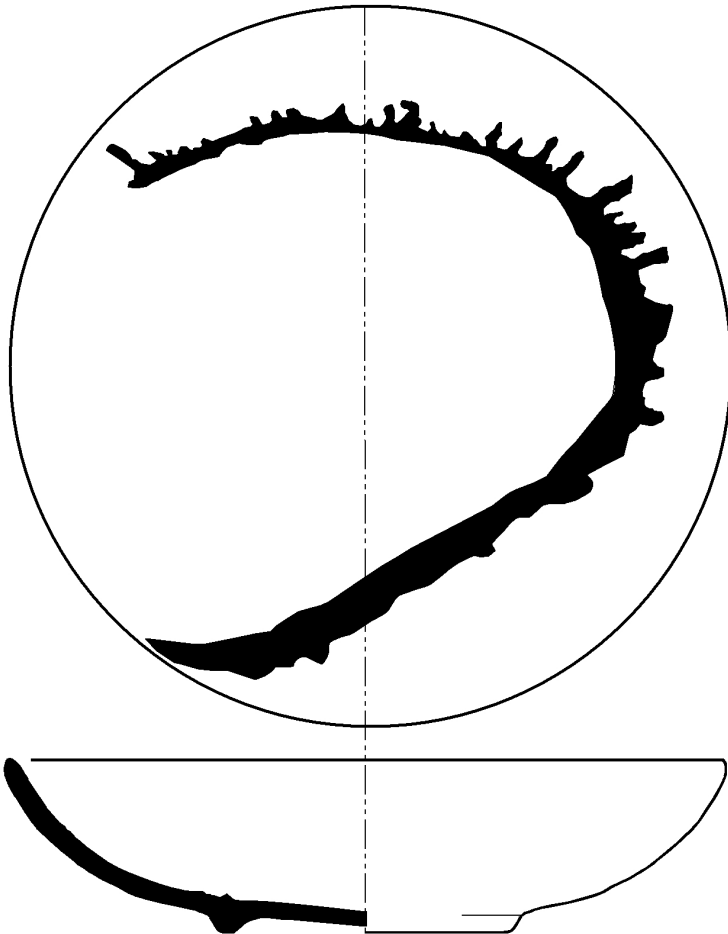

Nº 98.3 - P.151-119088



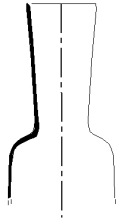

Nº 98.3 - P.151-119113

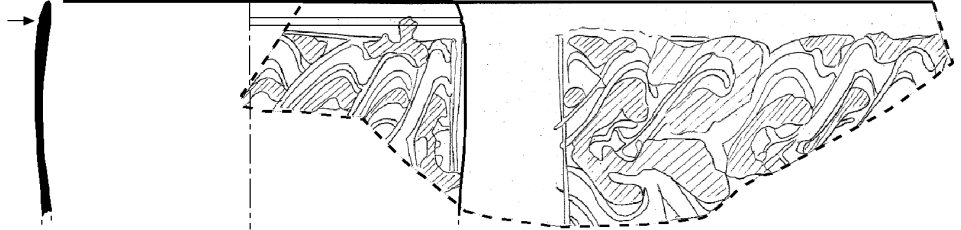

Nº 98.3 - P.151- 119086

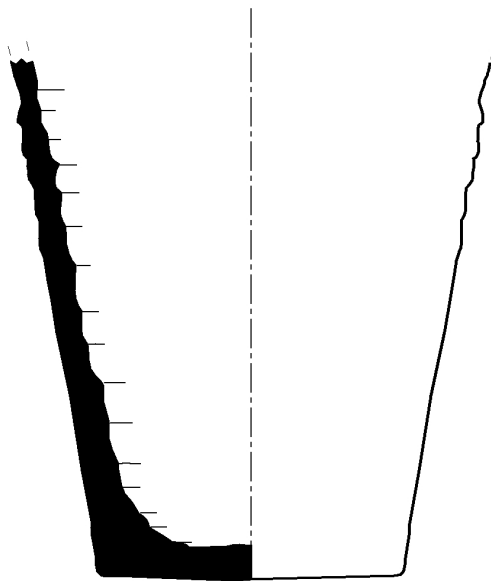

Nº 98.3 - P.151 - 118998

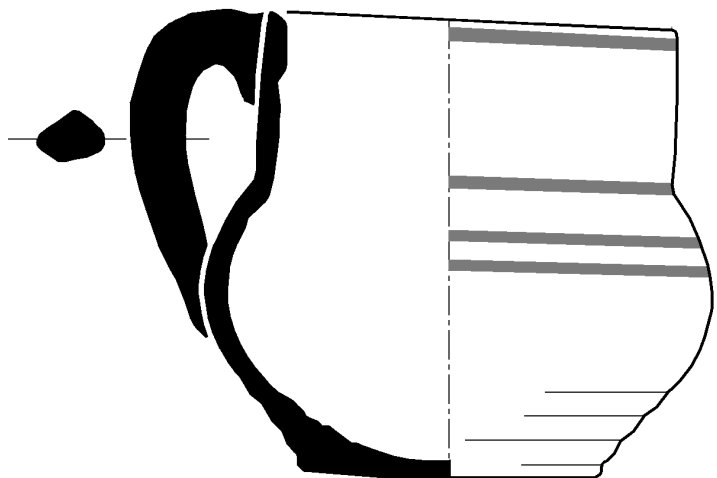

Nº 98.3 - P.151 - 118978

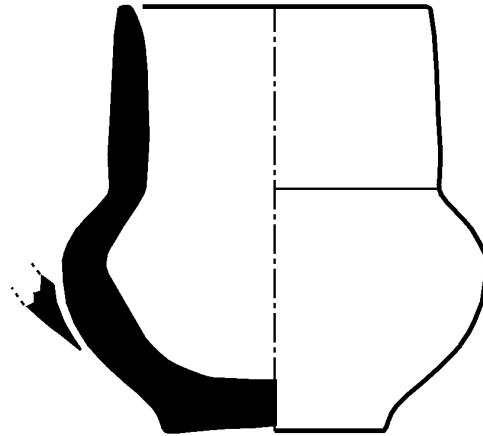

Nº 98.3 - P.153 - 119612

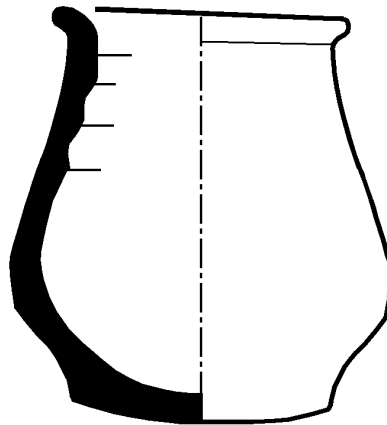

Nº 98.3 - P.153 - 119631

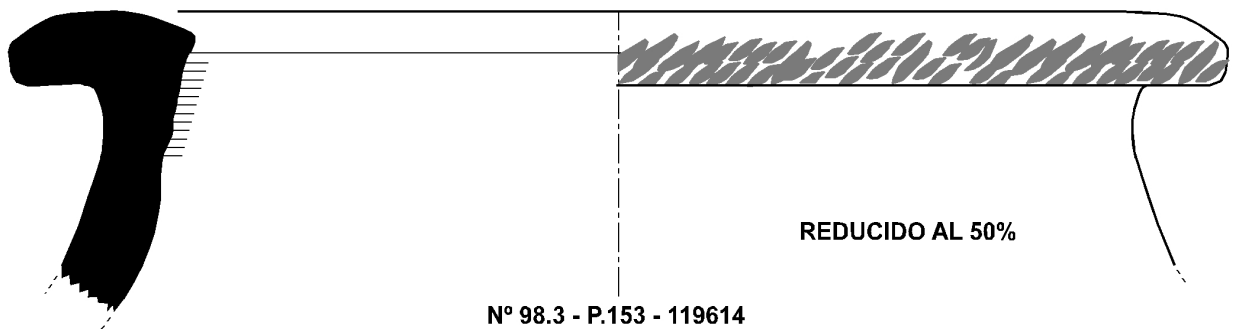

Nº 98.3 - P.153 - 119614

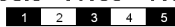

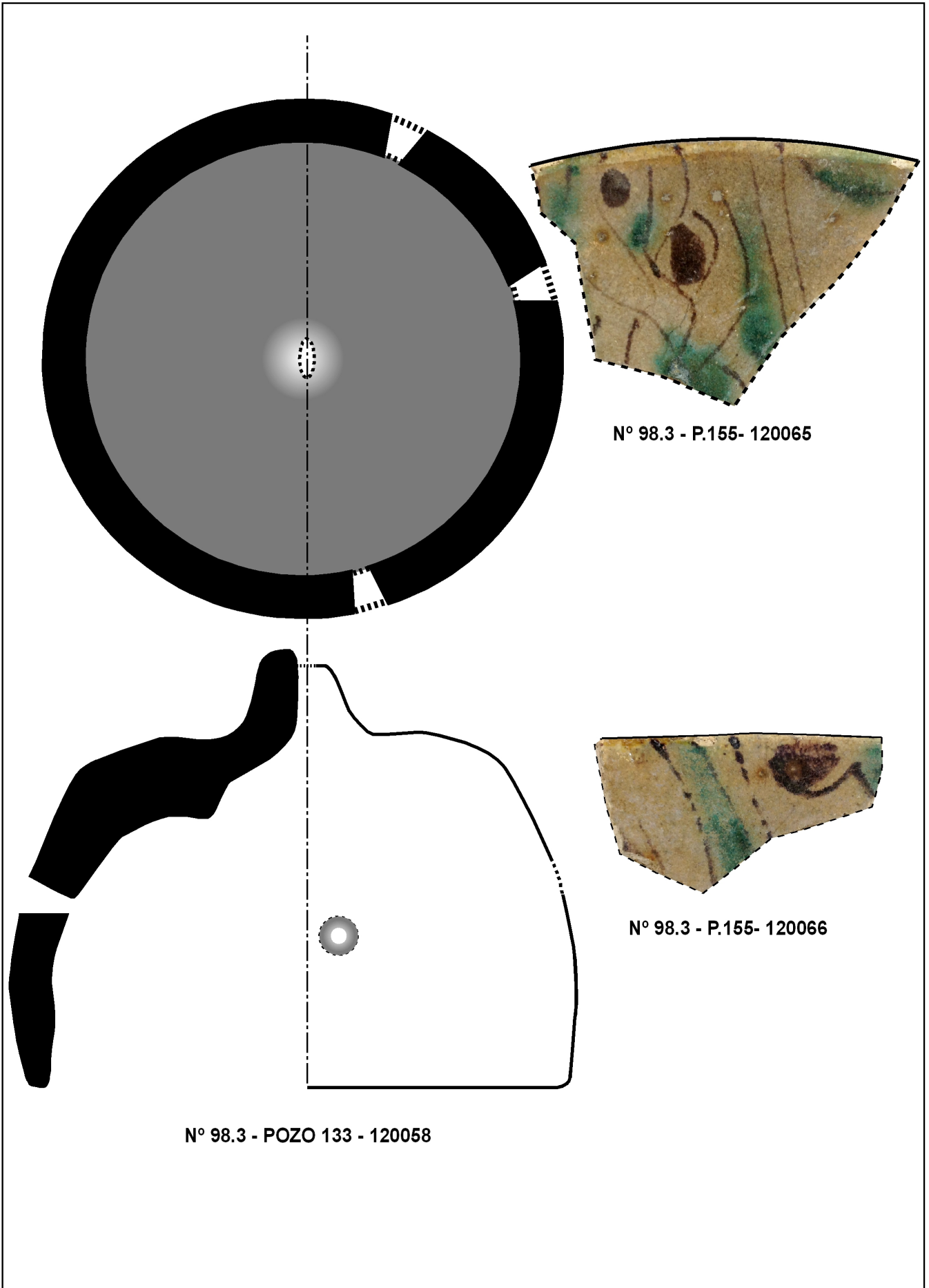

Nº 98.3 - P.155- 120065

Nº 98.3 - P.155- 120066

Nº 98.3 - POZO 133 - 120058



LÁMINA POZO 167

ESCALA: 5 cm.



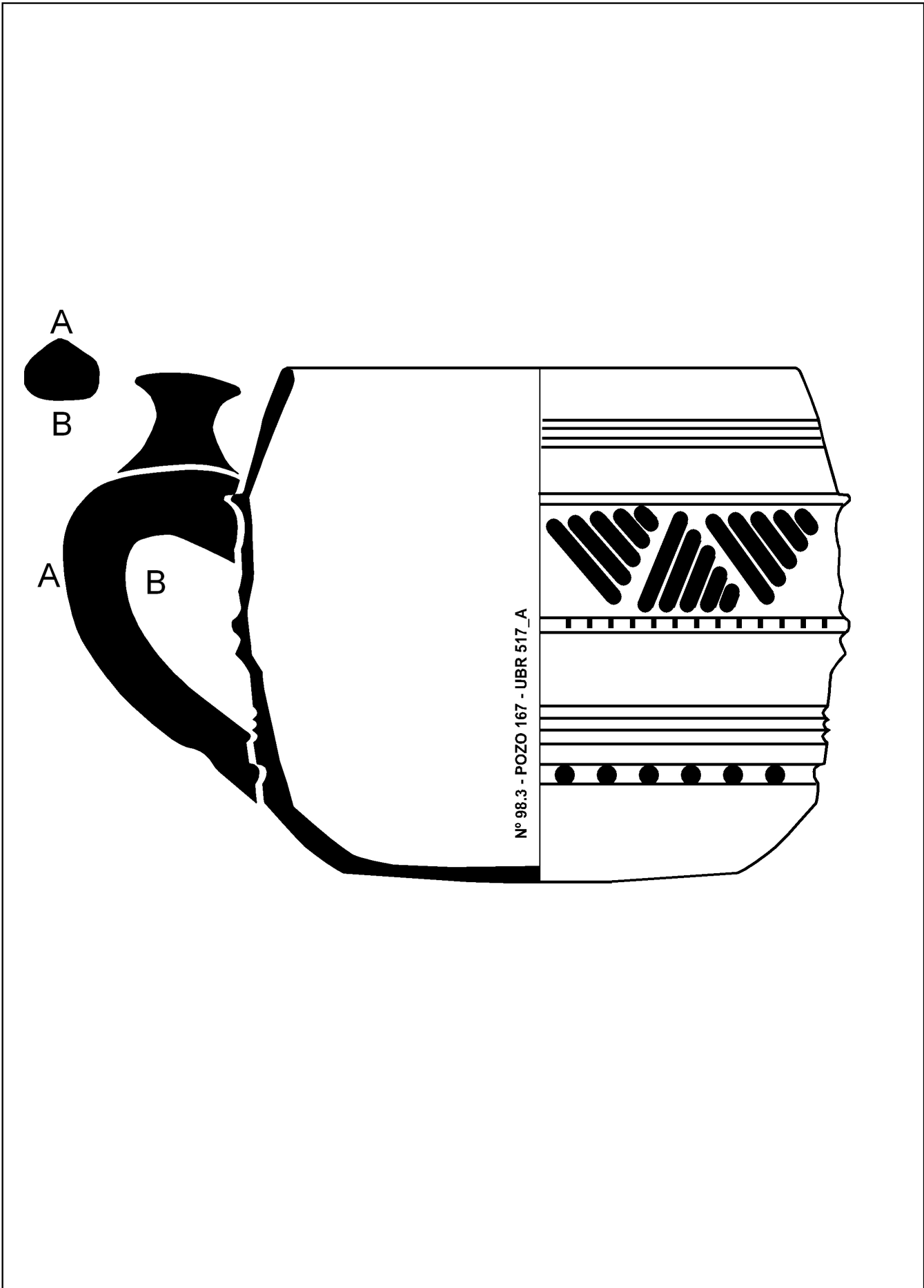
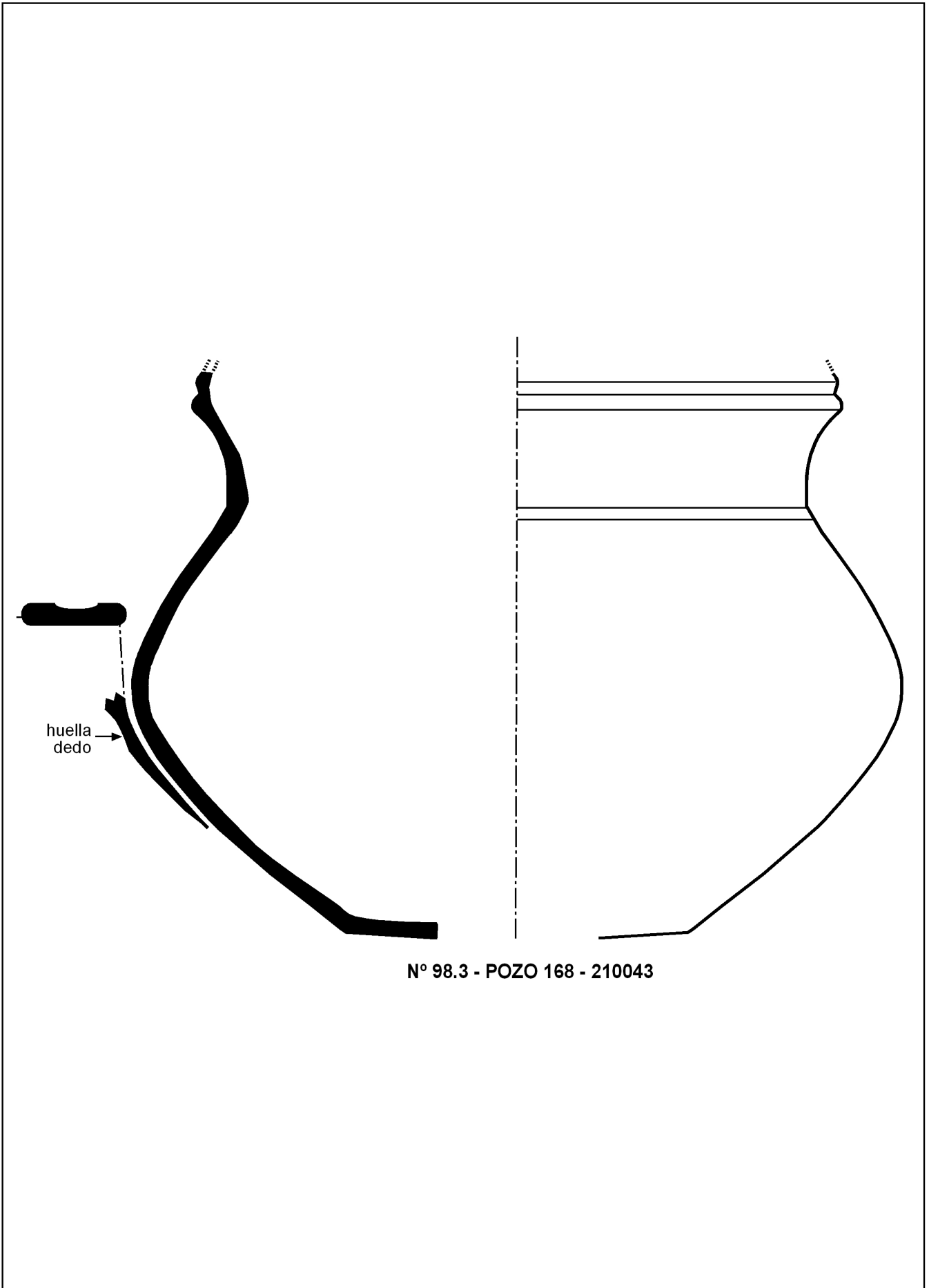

Nº 98.3 - POZO 168 - 210043

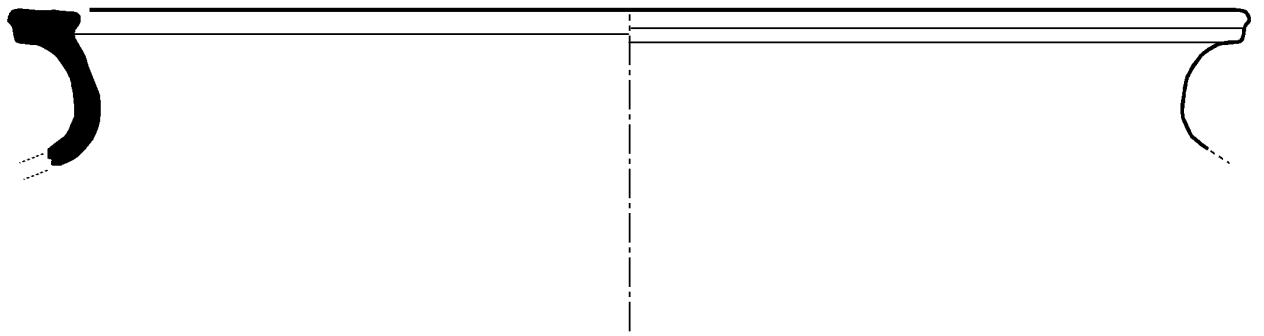

Nº 98.3 - POZO 180 - 182169

LÁMINA POZO 180

ESCALA: 5 cm.





Nº 98.3 - POZO 181 - UBR270A

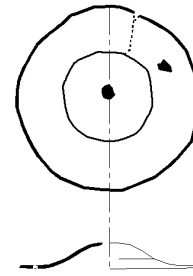

Nº 98.3 - P.181 - 193889



Nº 98.3 - P.181 - 193870

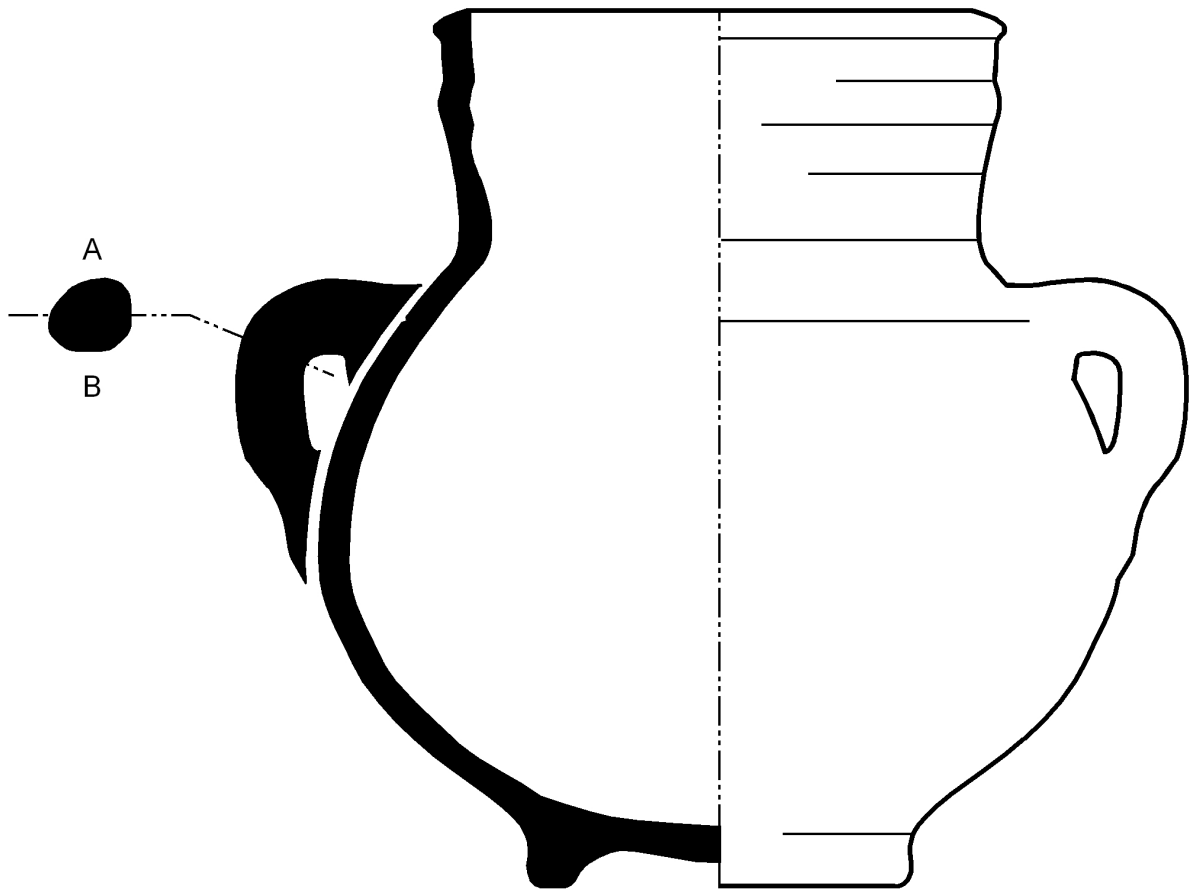

Nº 98.3 - POZO 185 - 993A



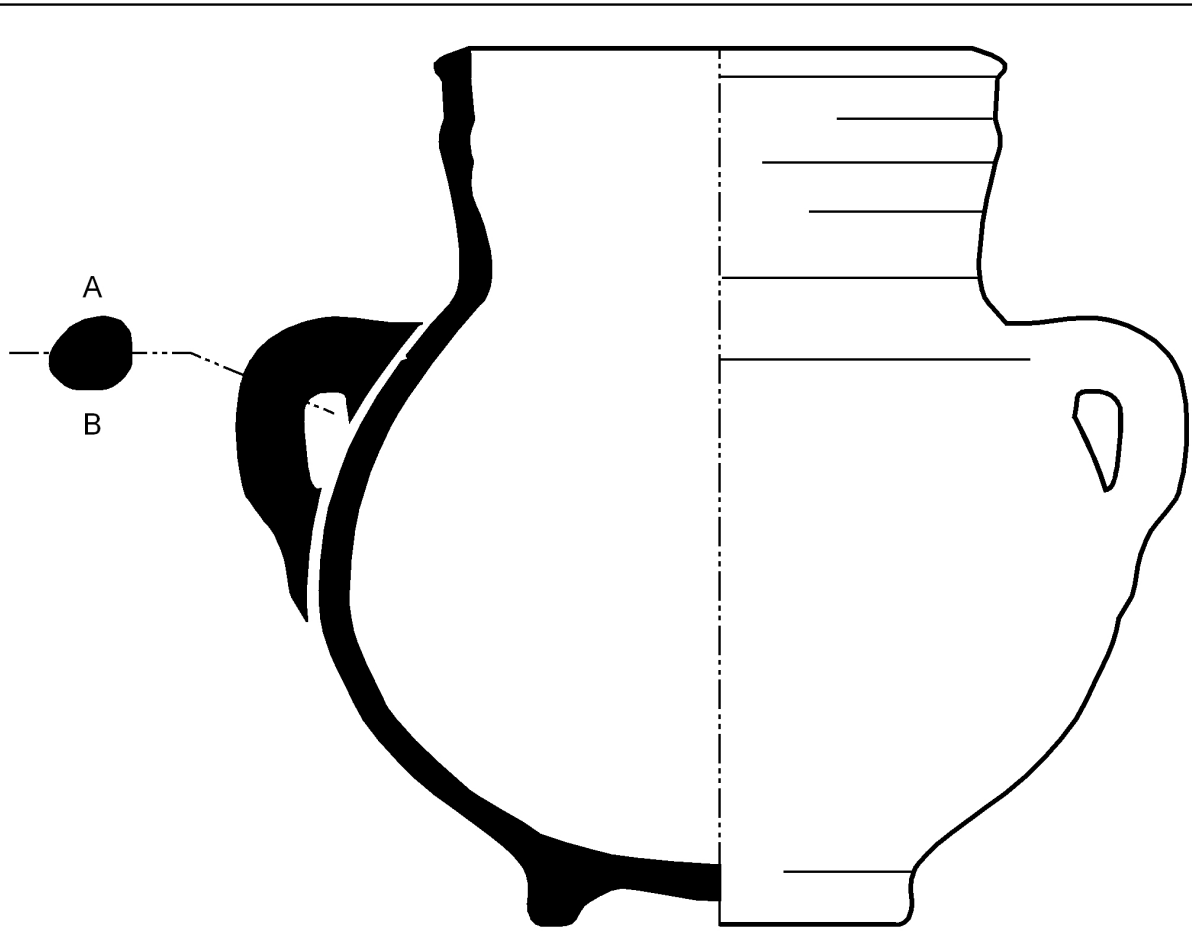

Nº 98.3 - POZO 189 - 993A

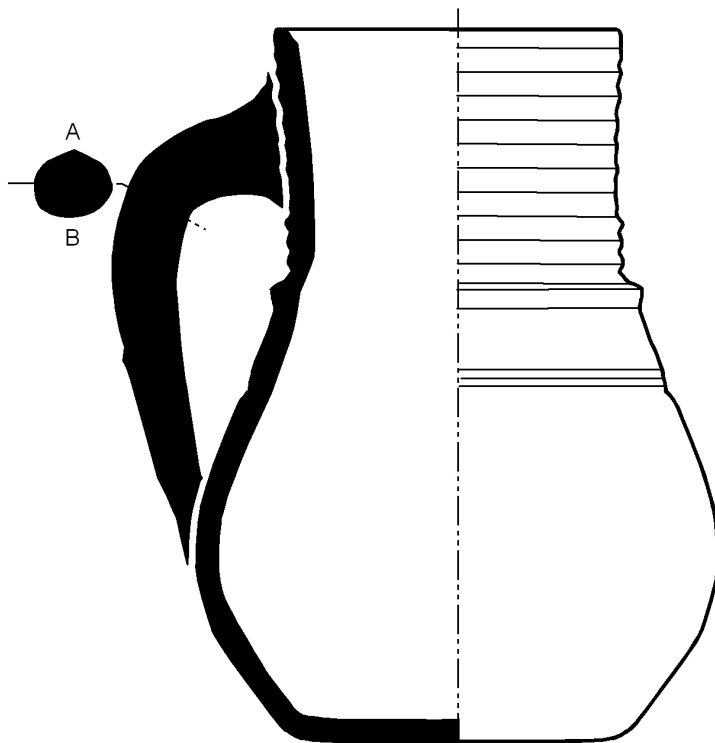

Nº 98.3 - POZO 189 - CAJA 119\_A

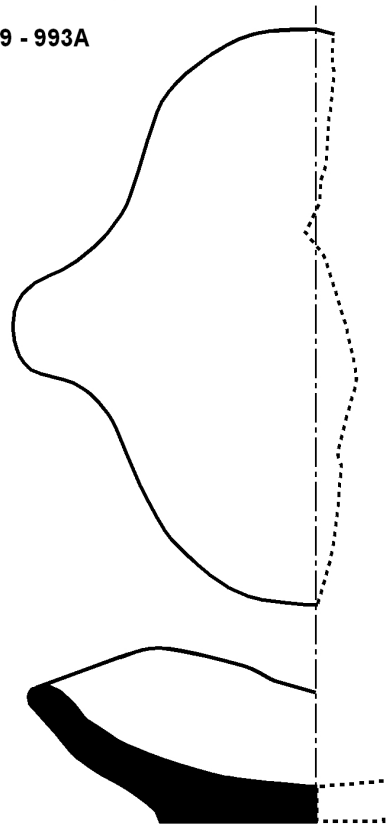

Nº 98.3 - Pozo 189 - 184218

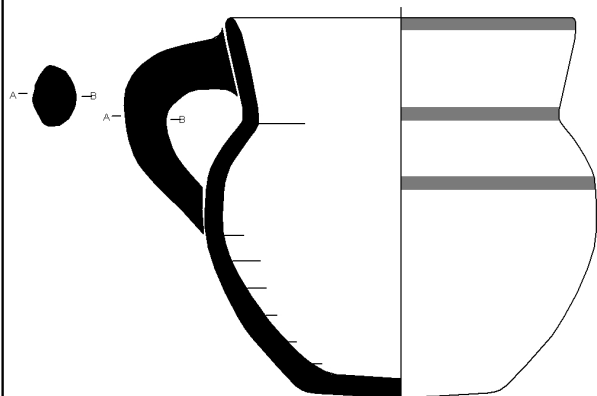

Nº 98.3 - P.191 - 197762

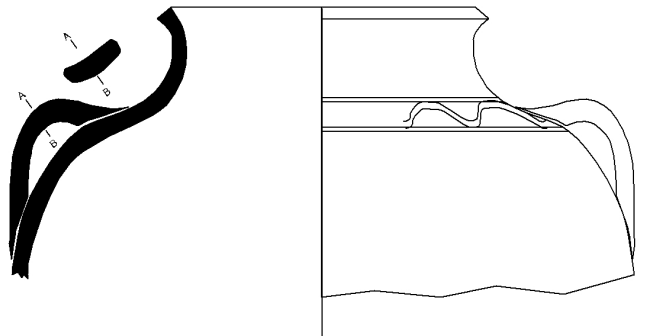

Nº 98.3 - P.191 - 197230

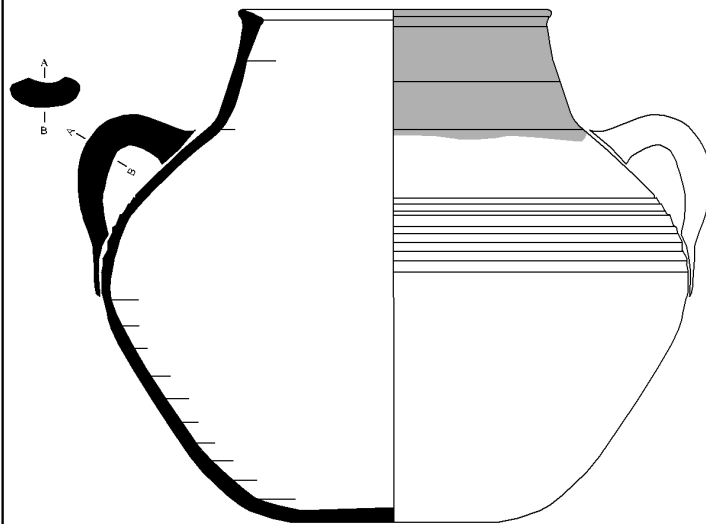

Nº 98.3 - P.191 - 197372

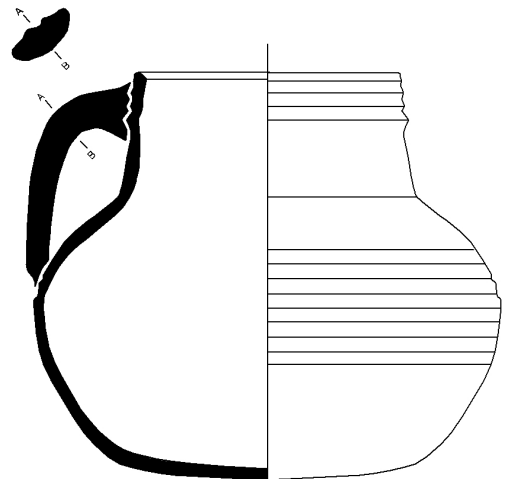

Nº 98.3 - P.191 - 197228

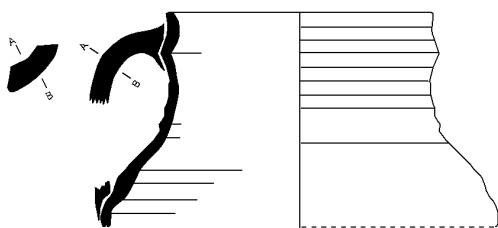

Nº 98.3 - P.191 - 197375

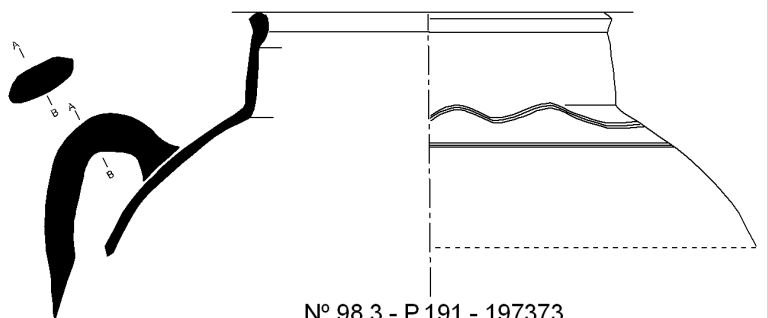

Nº 98.3 - P.191 - 197373

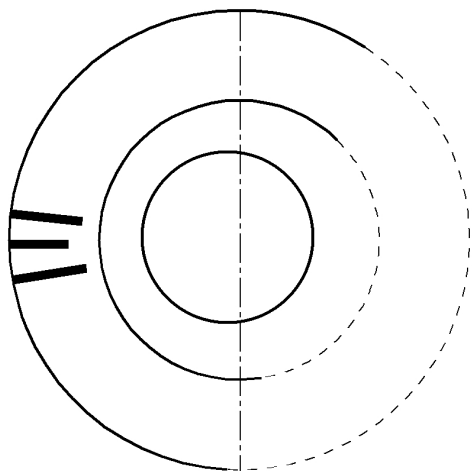

Nº 98.3 - P.191 - 198423

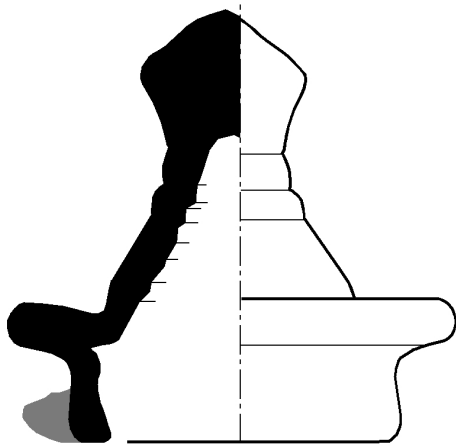

98.3 - POZO 191 - 109B

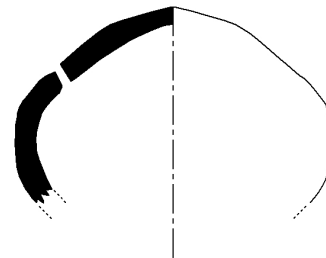

Nº 98.3 - P.191 - 197076

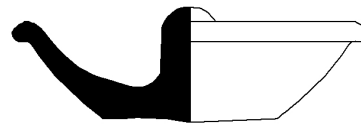

Nº 98.3 - P.191 - 197081

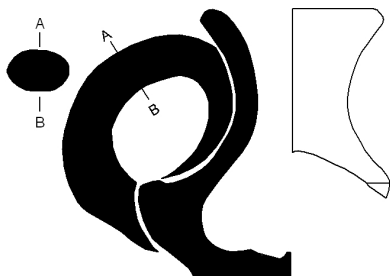

Nº 98.3 - P.191 - 197061

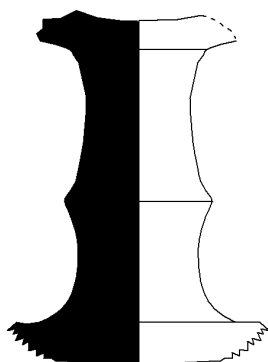
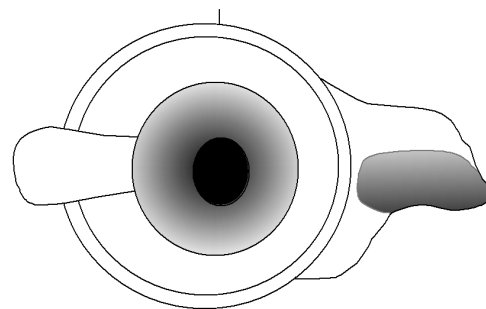

Nº 98.3 - P.191 - 197301

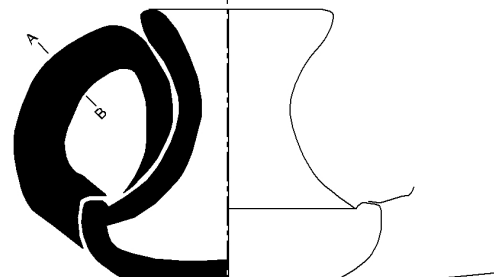

Nº 98.3 - P.191 - 197761

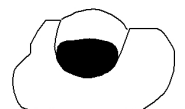

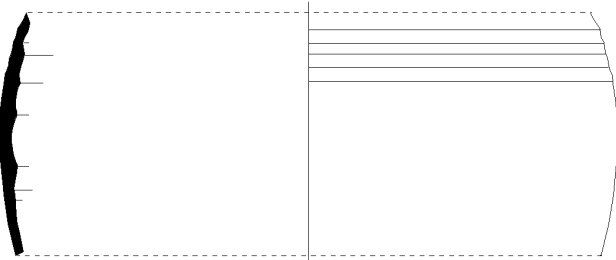

N° 98.3 - P.191 - 197264

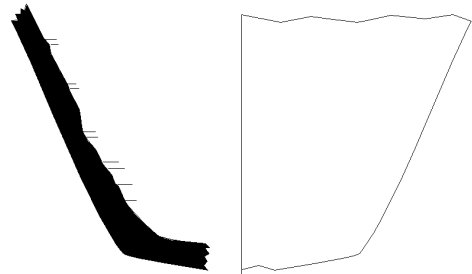

N° 98.3 - P.191 - 197118

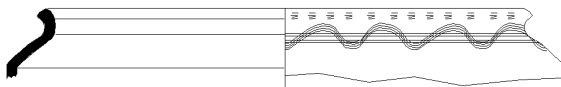

N° 98.3 - P.191 - 197229

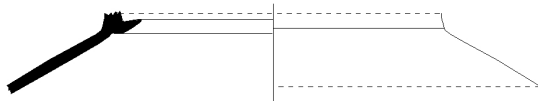

N° 98.3 - P.191 - 197255

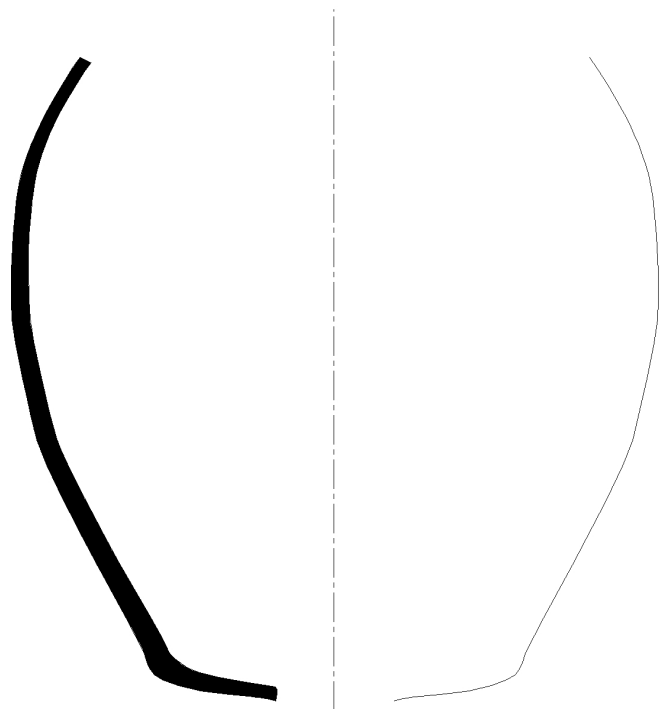

N° 98.3 - P.191 - 197033

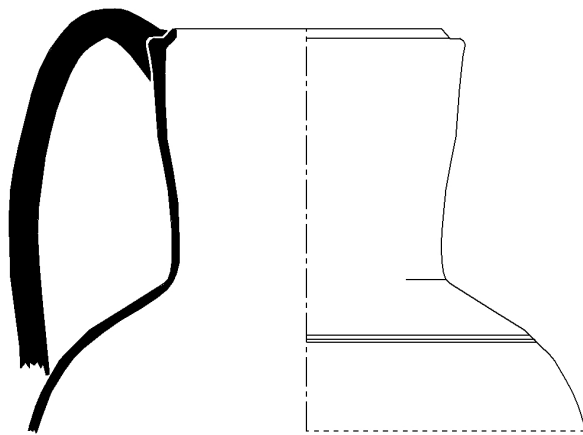

Nº 98.3 - P.191 - 197238

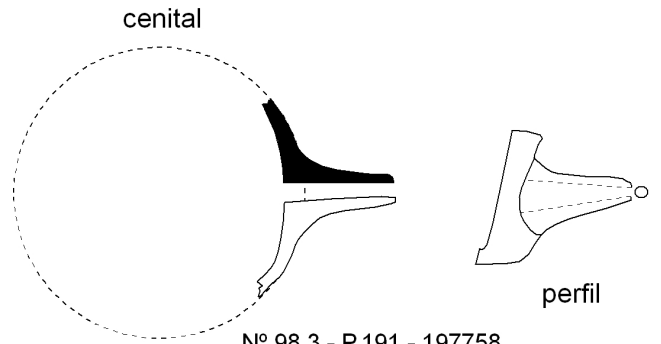

Nº 98.3 - P.191 - 197758



Nº 98.3 - P.191 - 194270

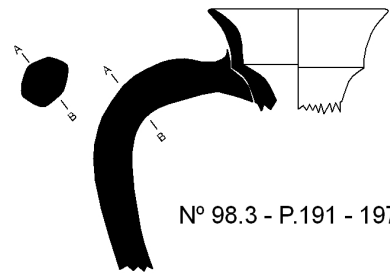

Nº 98.3 - P.191 - 197303

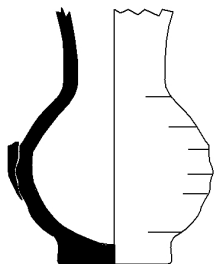

Nº 98.3 - P.191 - 197100

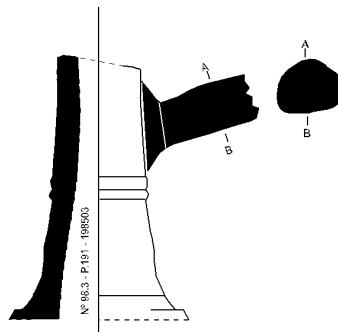

Nº 98.3 - P.191 - 198501 (asa)

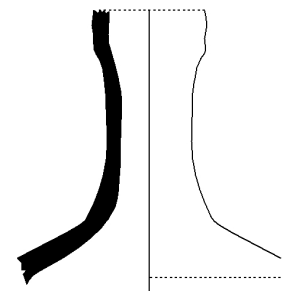

Nº 98.3 - P.191 - 198427

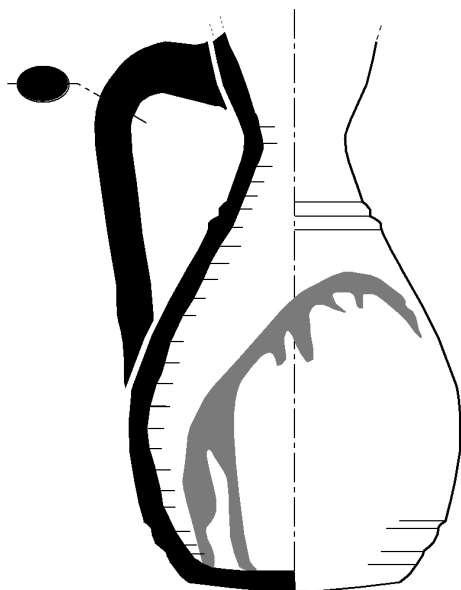

98.3 - POZO 191 - 110D

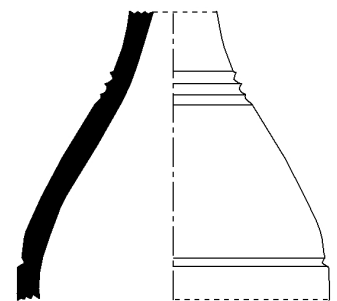

Nº 98.3 - P.191 - 197342

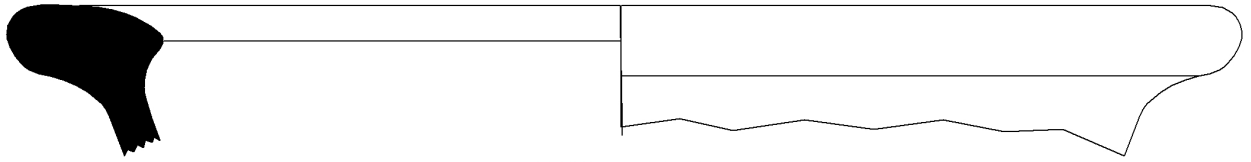
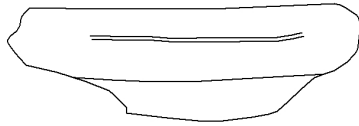

Nº 98.3 - P.191 - 197069

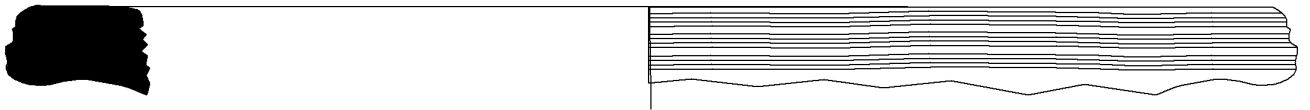

Nº 98.3 - P.191 - 197070

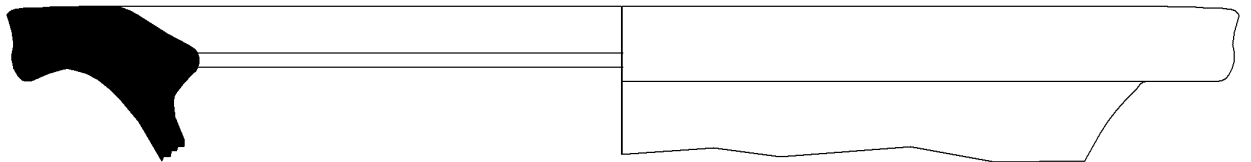

Nº 98.3 - P.191 - 197068

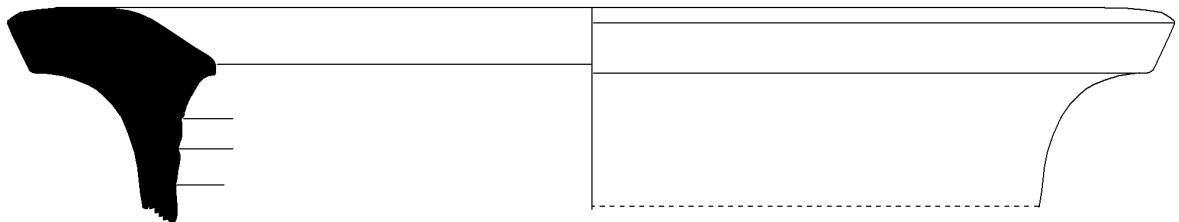

Nº 98.3 - P.191 - 197837

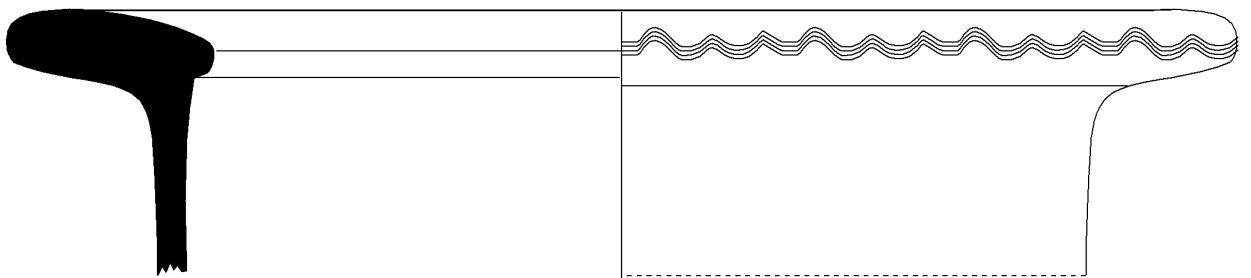

Nº 98.3 - P.191 - 197836

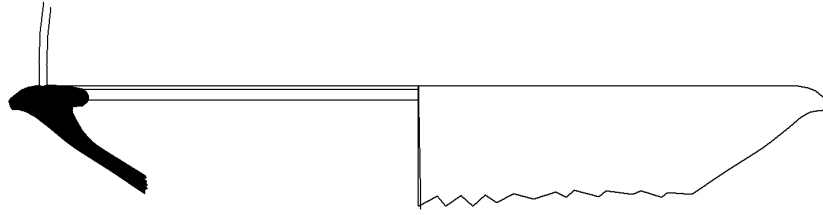

Nº 98.3 - P.191 - 197064

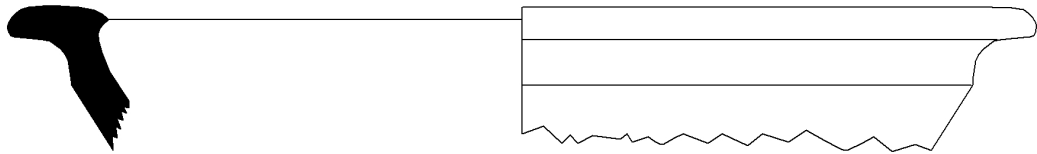

Nº 98.3 - P.191 - 197062

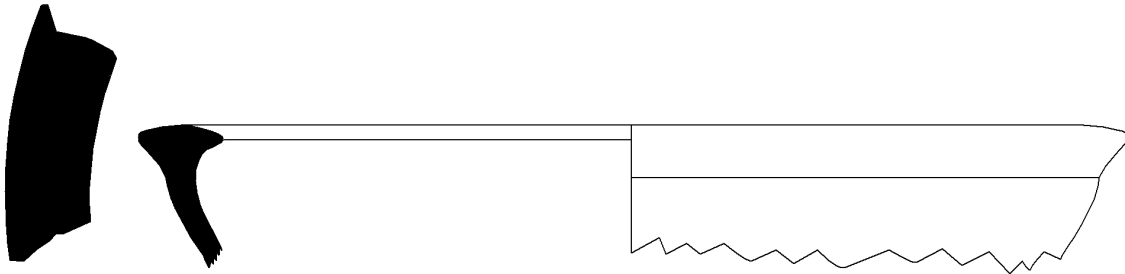

Nº 98.3 - P.191 - 197063

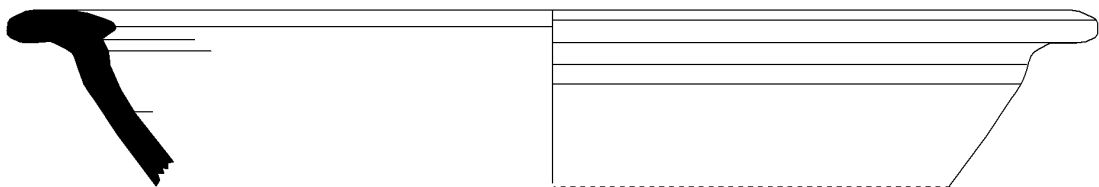

Nº 98.3 - P.191 - 197834

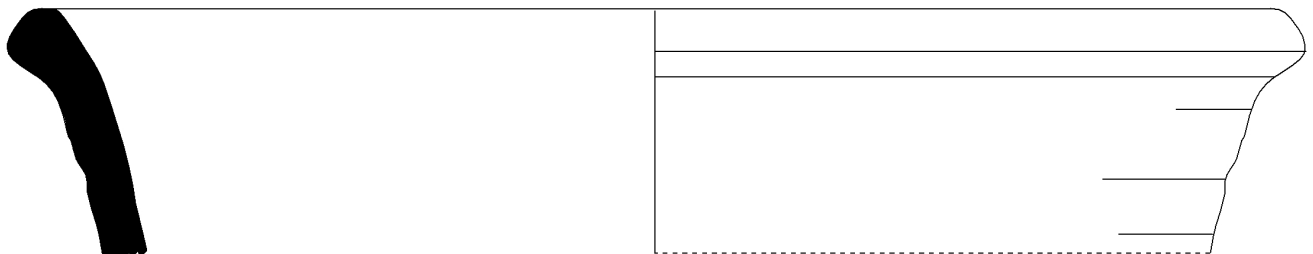

Nº 98.3 - P.191 - 197835



98.3 - POZO 191 - 109F

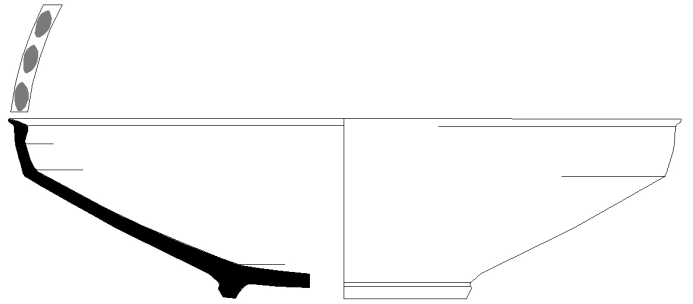

Nº 98.3 - P.191 - 197306

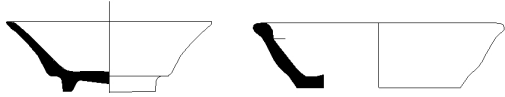

Nº 98.3 - P.191 - 198429

Nº 98.3 - P.191 - 198424



Nº 98.3 - P.191 - 198430

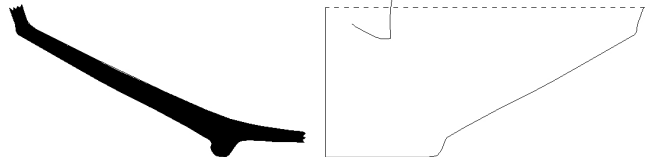

Nº 98.3 - P.191 - 197323

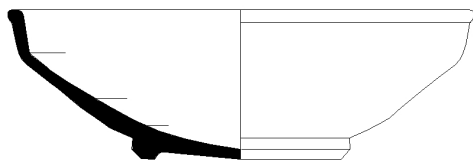

Nº 98.3 - P.191 - 198428

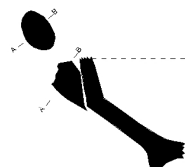

Nº 98.3 - P.191 - 197329



Nº 98.3 - P.191 - 197326

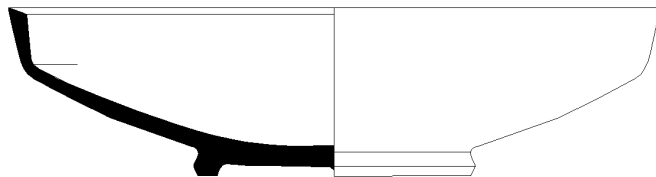

Nº 98.3 - P.191 - 197305



Nº 98.3 - P.191 - 198439

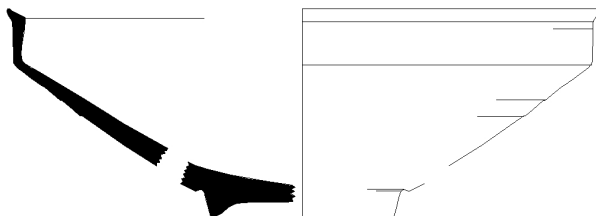

Nº 98.3 - P.191 - 194296



Nº 98.3 - P.191 - 197826





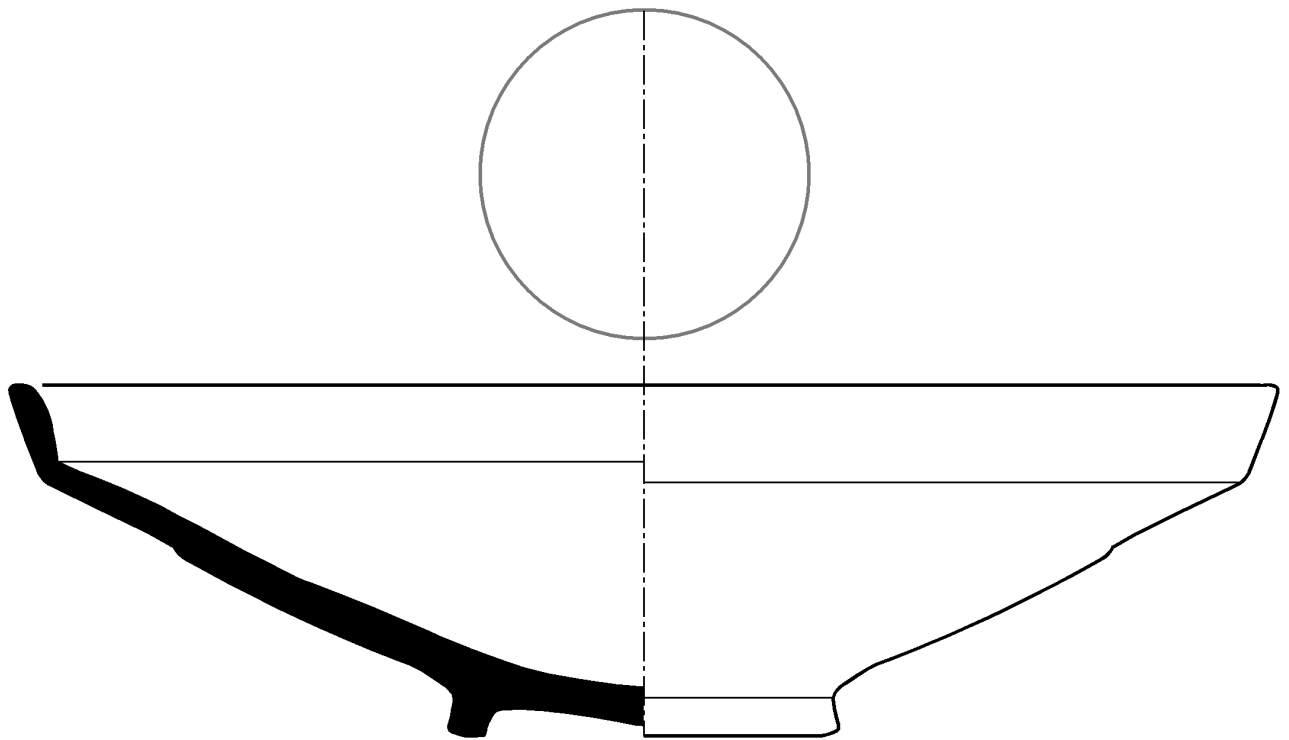

Nº 98.3 - POZO 195 - 95A

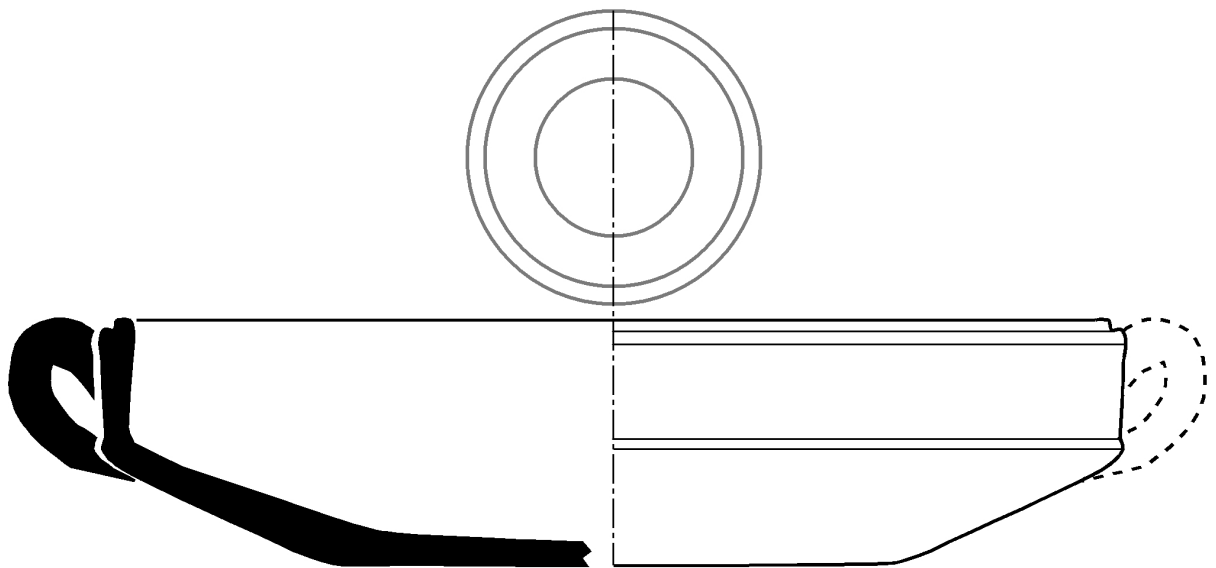

Nº 98.3 - POZO 195 - 95B

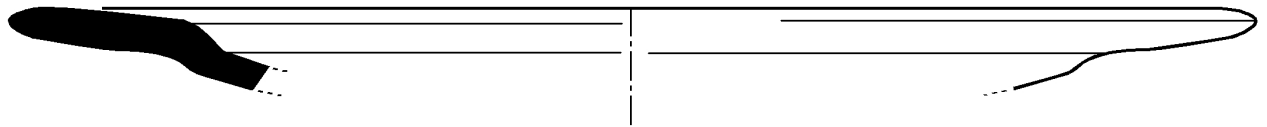

Nº 98.3 - POZO 196 - CAJA 95C

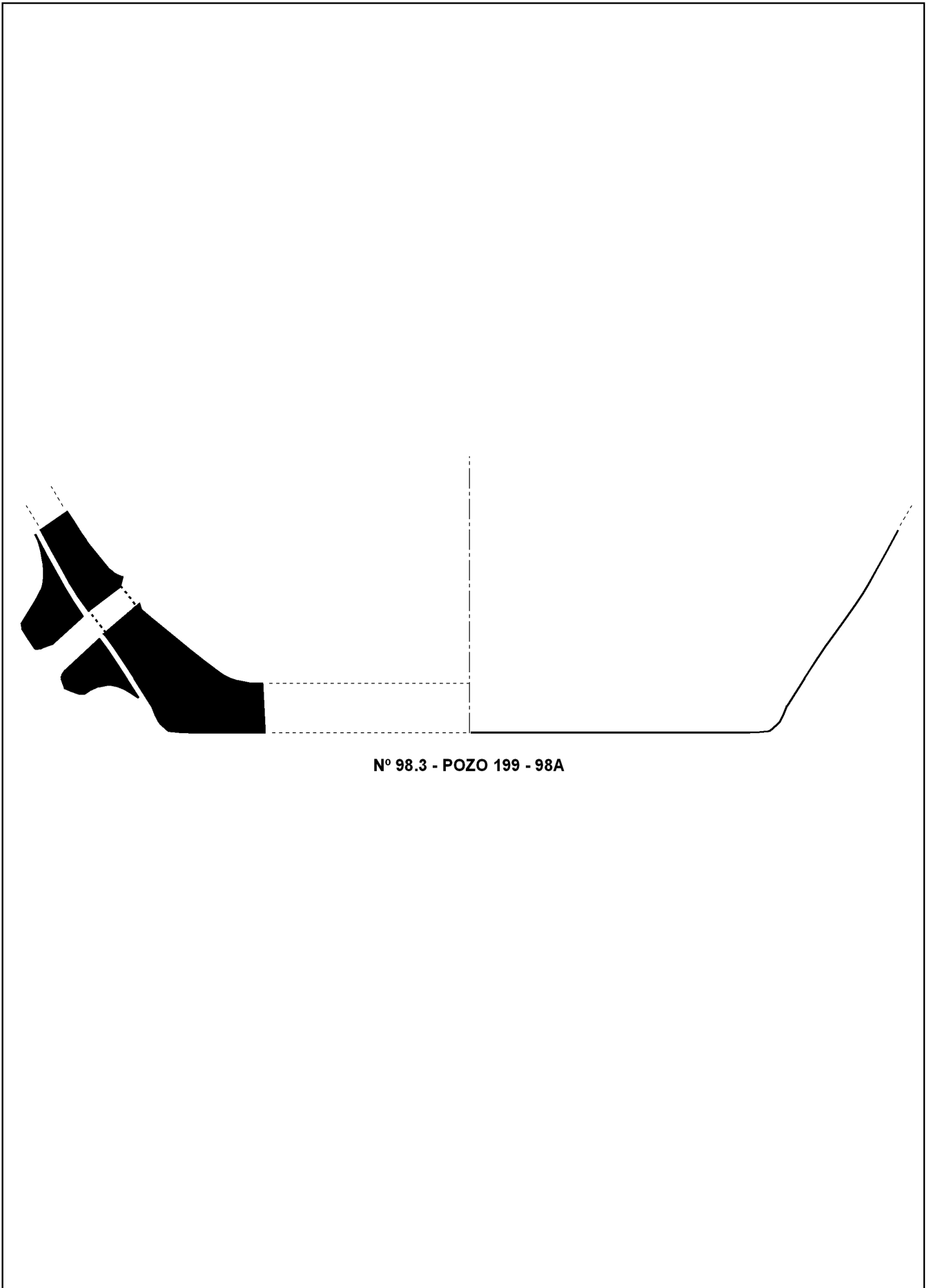

Nº 98.3 - POZO 199 - 98A

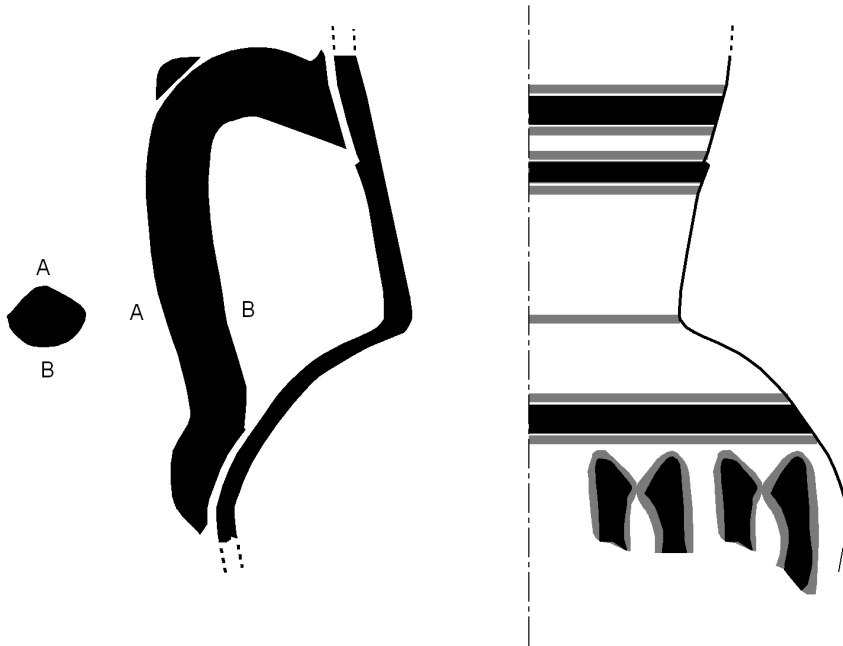

Nº 98.3 - POZO 210 - UBR 29\_C

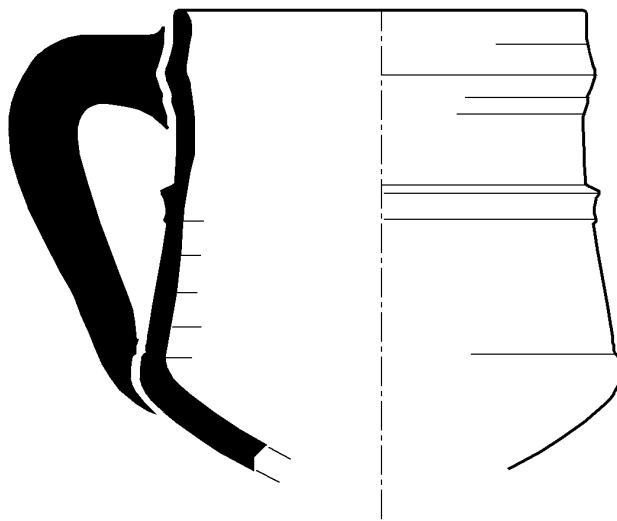

Nº 98.3 - POZO 210 - UBR 29\_D

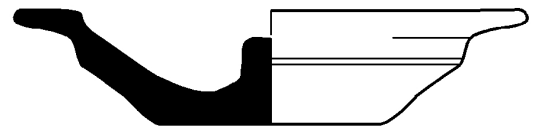

Nº 98.3 - POZO 210 - UBR 29\_E

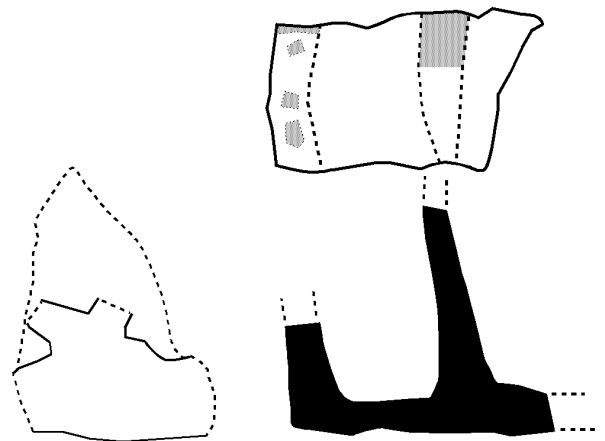

Nº 98.3 - POZO 210 - UBR 227A

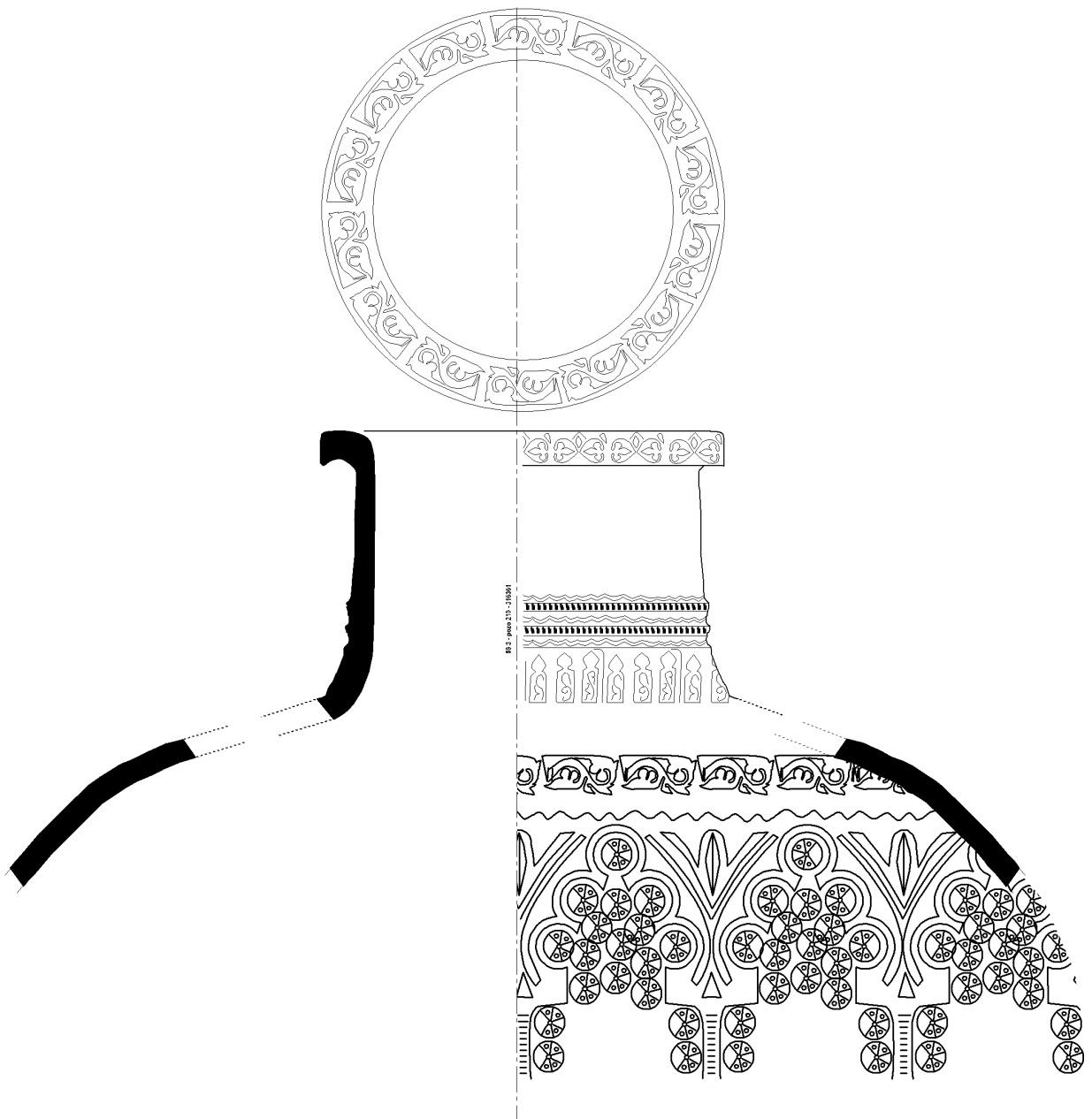

Nº 98.3 - POZO 210 - 316363

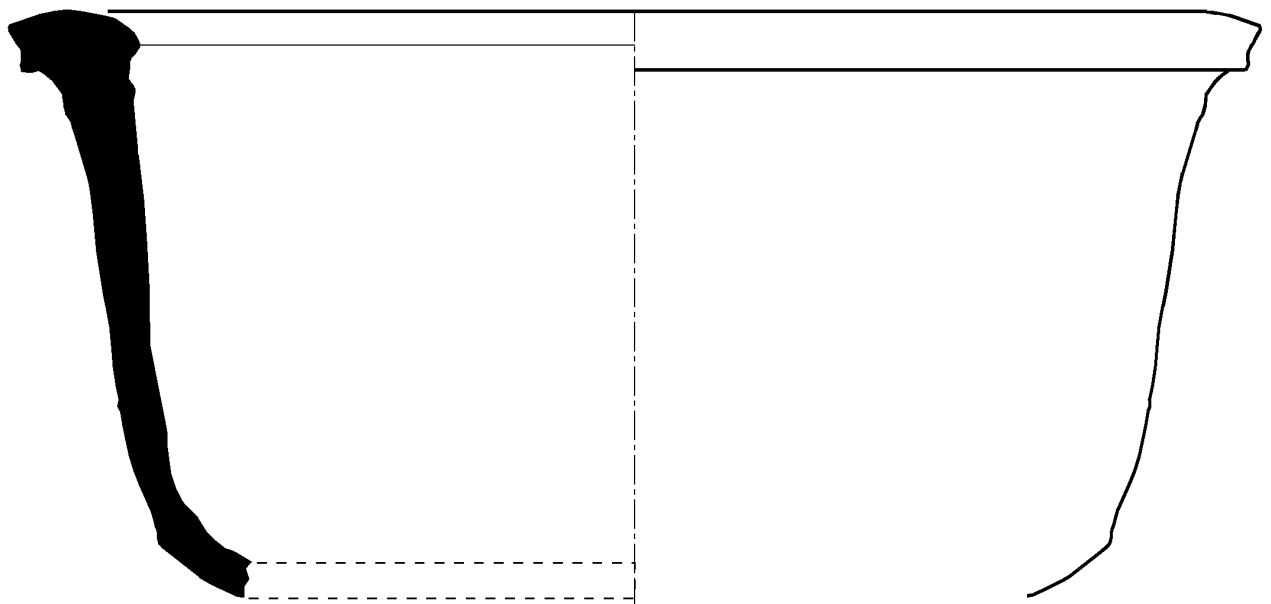

98.3 - POZO 215 - 107A

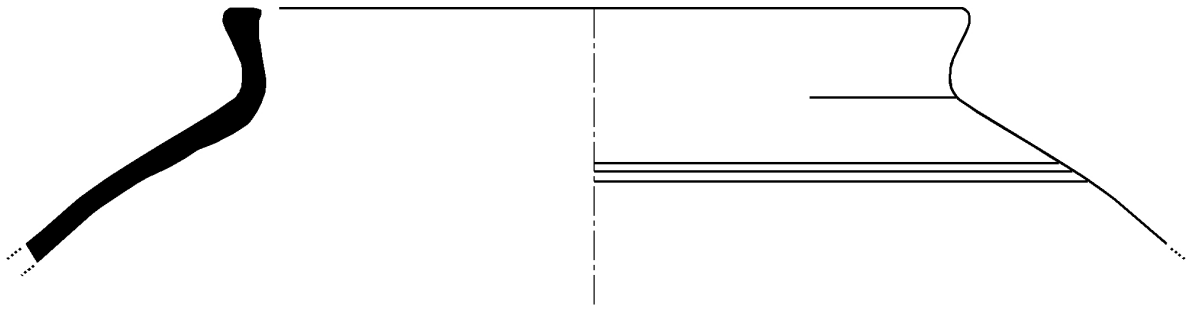

98.3 - POZO 218 - UBR336B



Nº 98.3 - POZO 227 - UBR33





LÁMINA POZO 230

ESCALA: 5 cm.



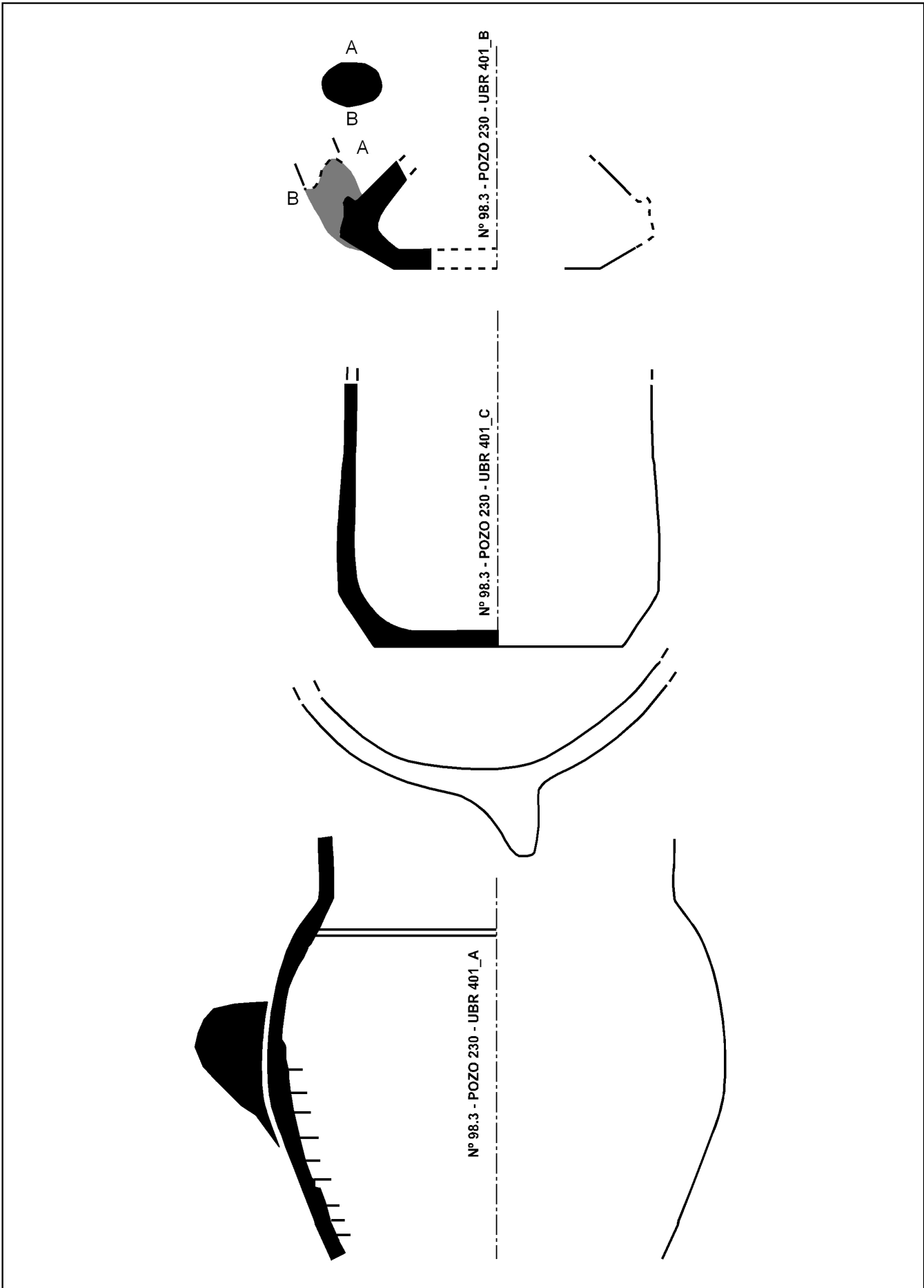
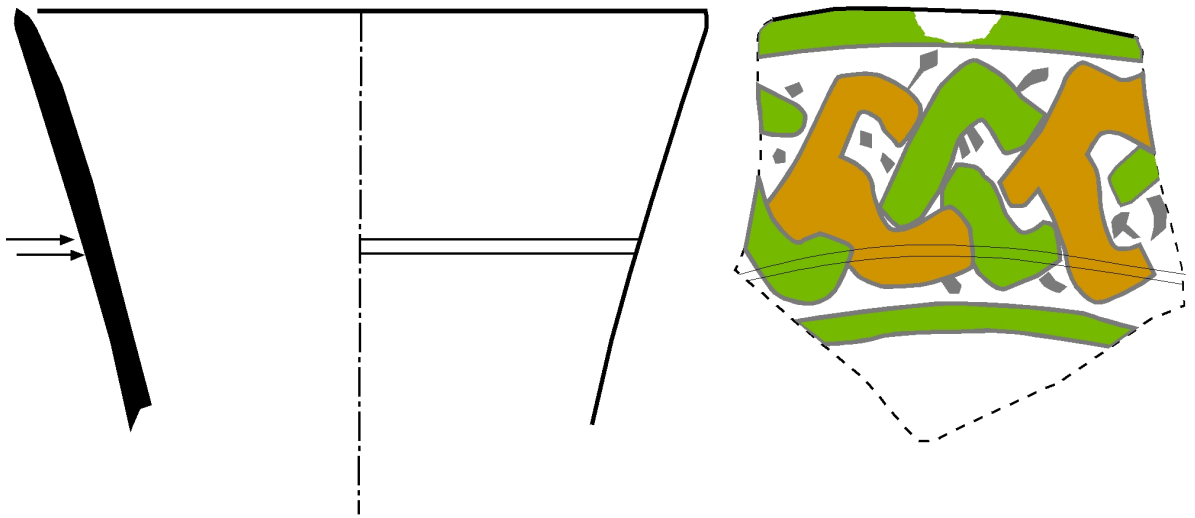

Nº 98.3 - POZO 235 - UBR207B

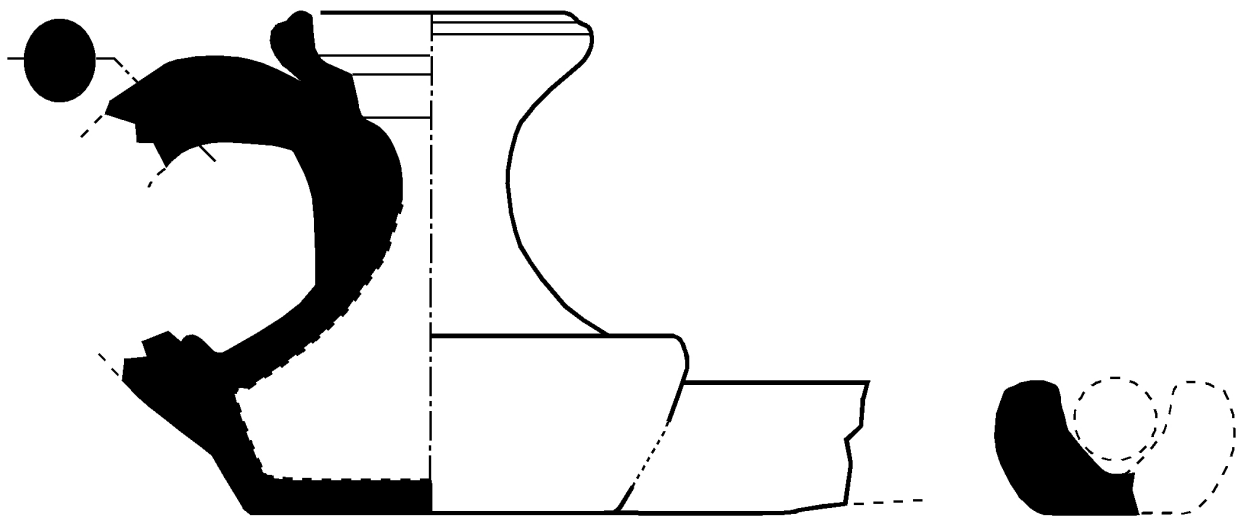

Nº 98.3 - POZO 235 - UBR207A

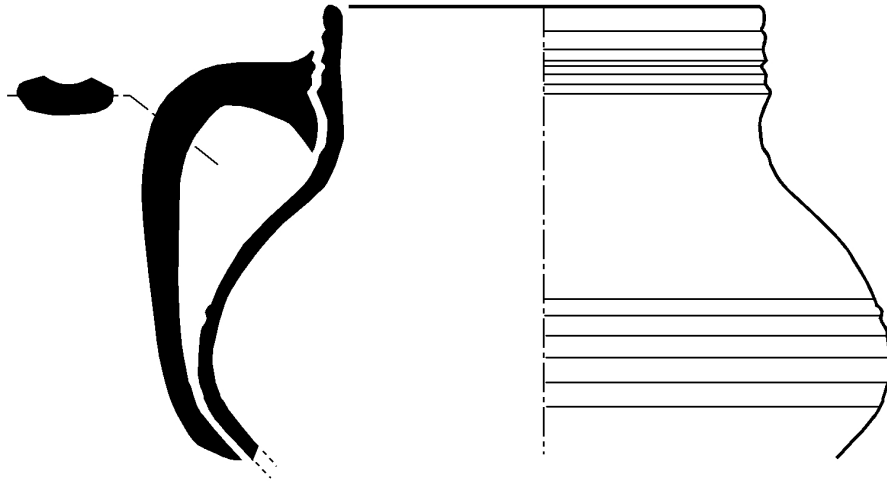

Nº 98.3 - POZO 237 - UBR304A

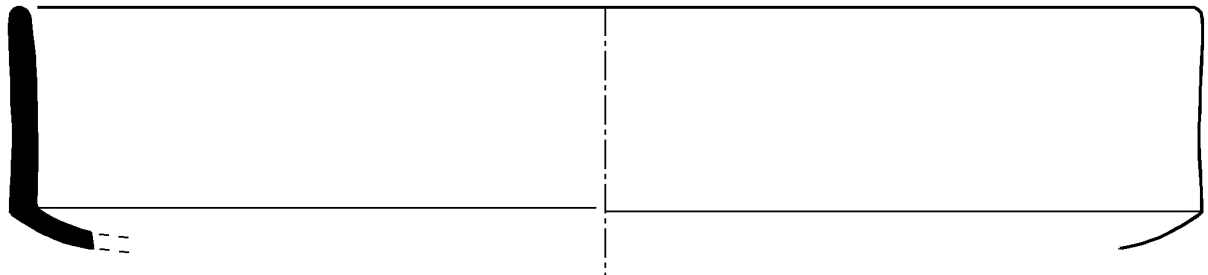

Nº 98.3 - POZO 237 - UBR272A

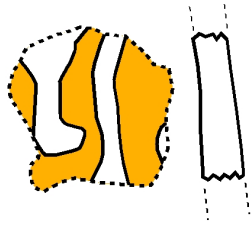

Nº 98.3 - POZO 245 - 326C

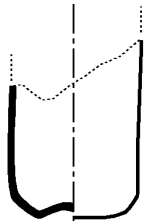

Nº 98.3 - POZO 245 - 326H

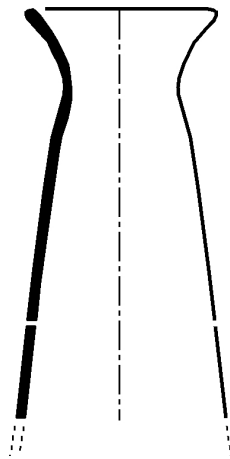

Nº 98.3 - POZO 245 - VIDRIO 326B

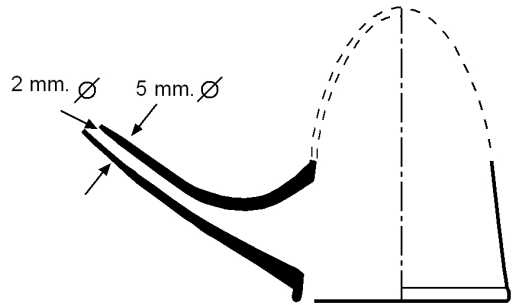

Nº 98.3 - POZO 245 - 326G

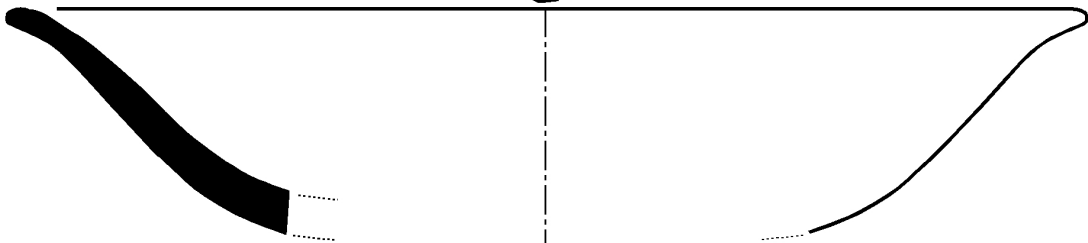
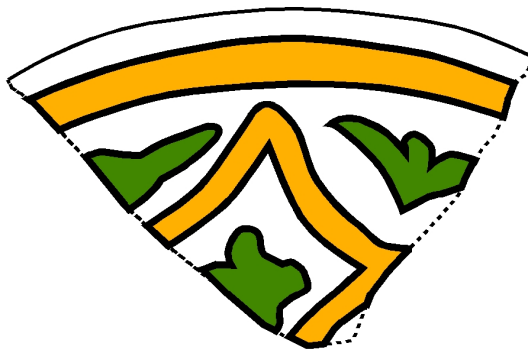

Nº 98.3 - POZO 245 - 326E

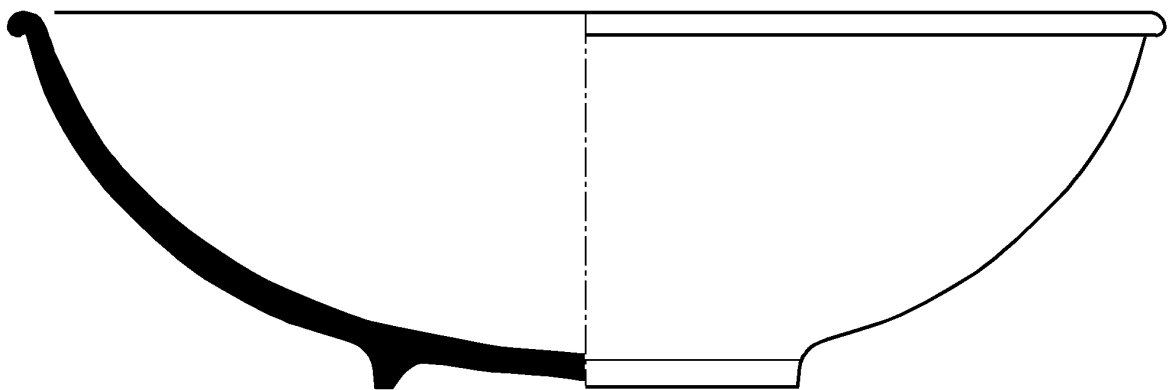

Nº 98.3 - POZO 245 - 326A

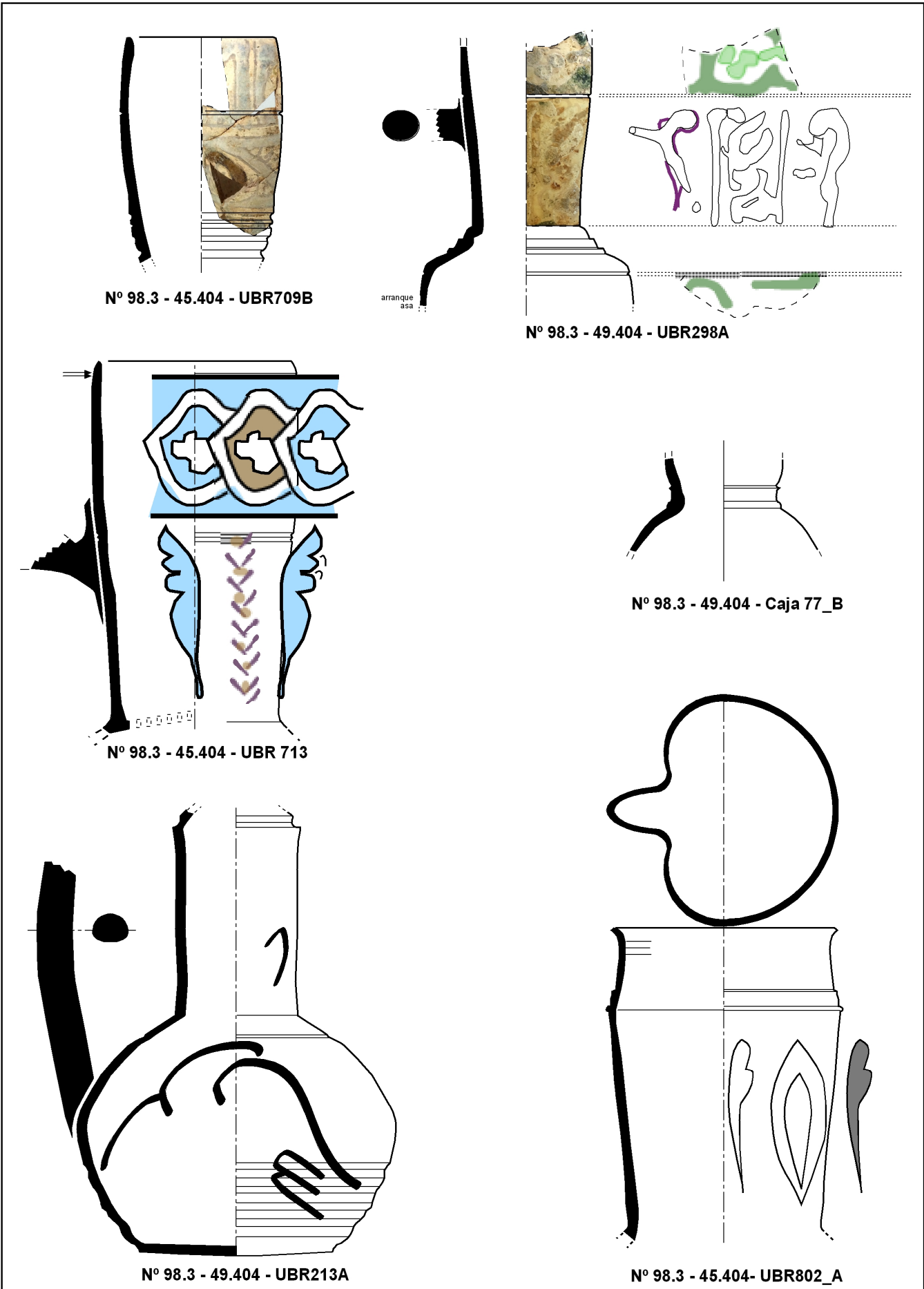



98.3 - 49.404 - 316349

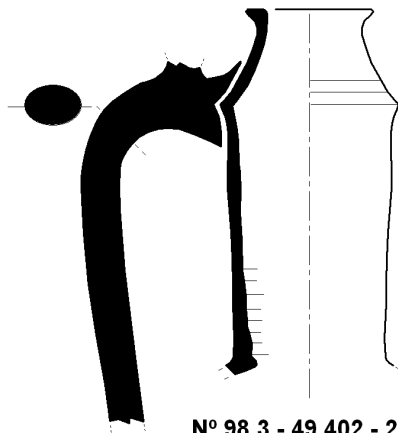

Nº 98.3 - 49.402 - 21B

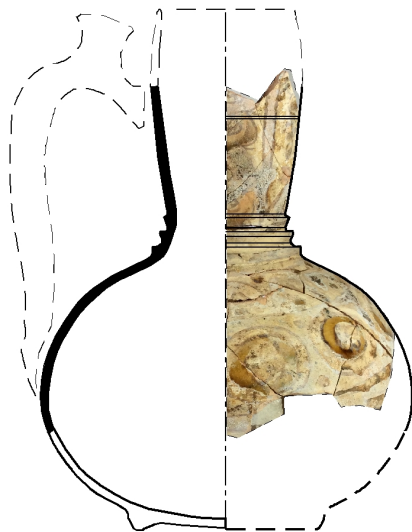

Nº 98.3 - 49.404 - UBR169A HIPOTESIS

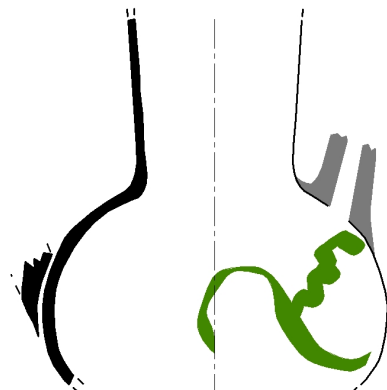

Nº 98.3 - 45.404 - UBR 730\_A

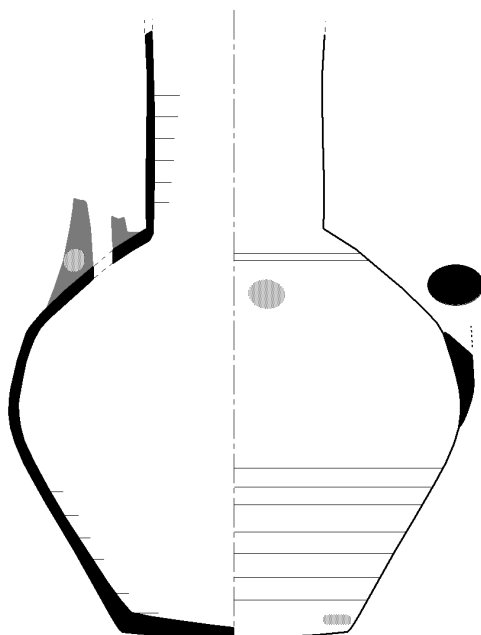

Nº 98.3 - 49.404 - 2E

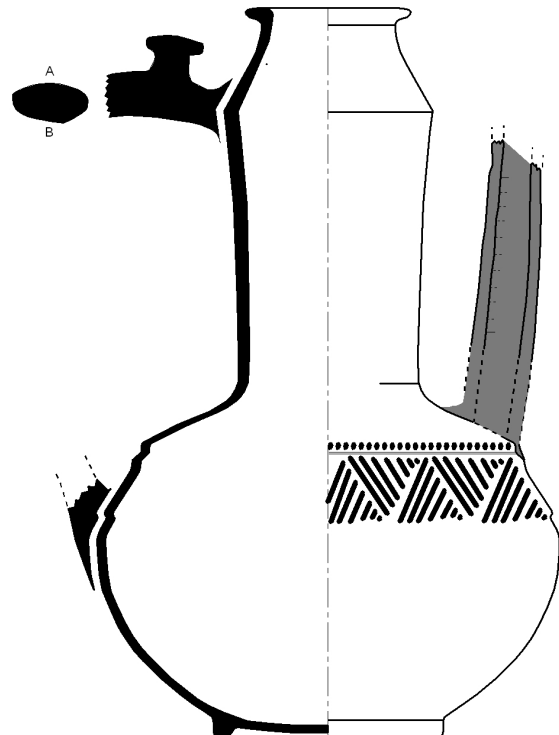

Nº 98.3 - 49.402 - CAJA 35\_B

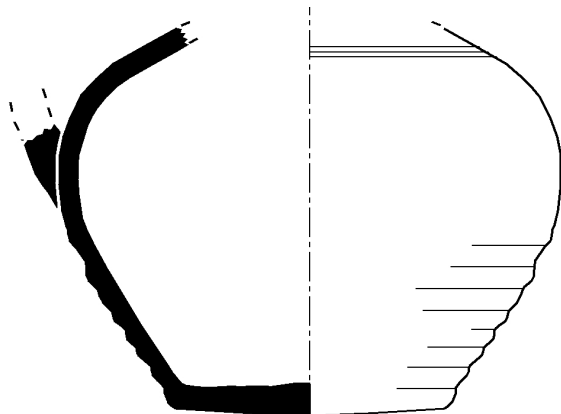

Nº 98.3 - 49.404 - CAJA 1\_A

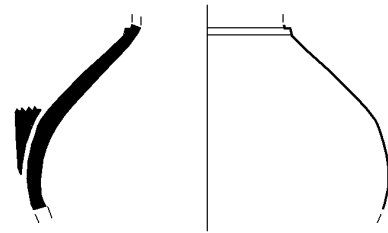

Nº 98.3 - 49.404 - CAJA 93\_A

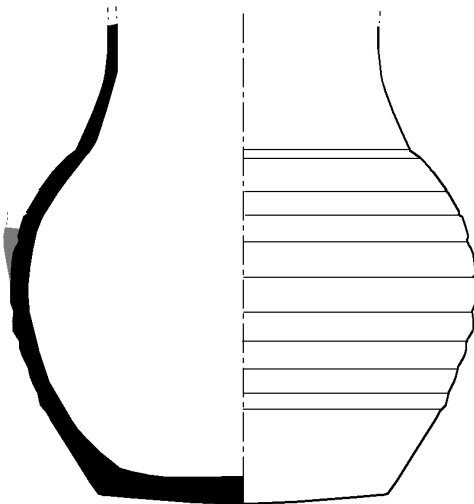

Nº 98.3 - 49.404 - 2B

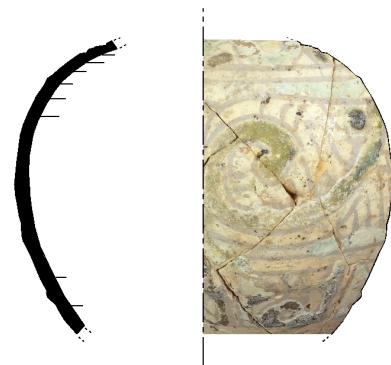

Nº 98.3 - 49.404 - UBR60A

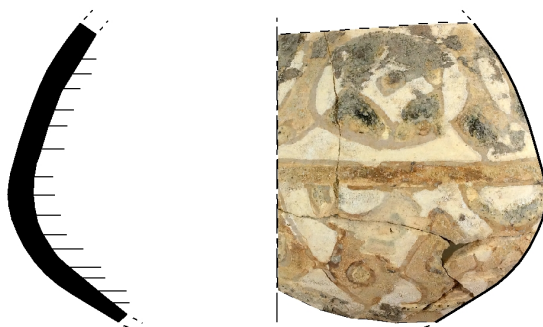

Nº 98.3 - 45.404 - UBR405A

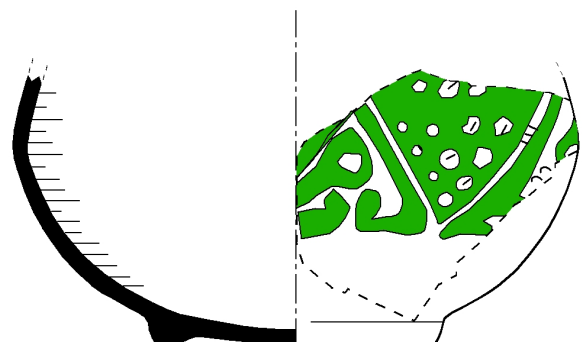

Nº 98.3 - 45.404 - UBR436A

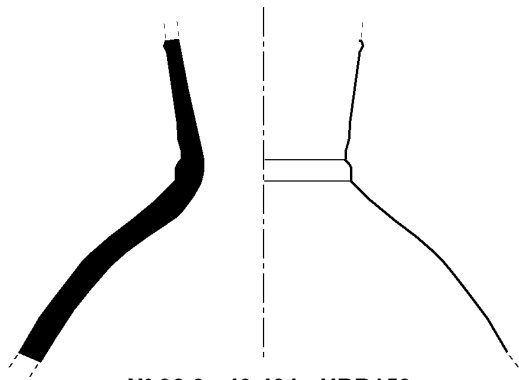

Nº 98.3 - 49.404 - UBR152

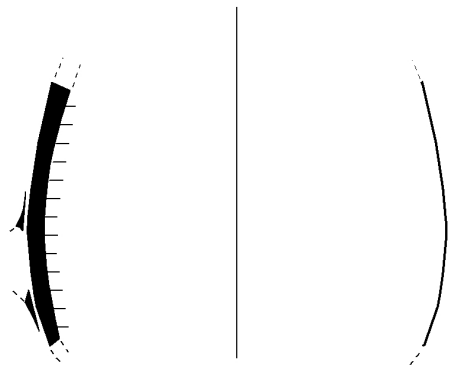

Nº 98.3 - 45.404 - UBR 404\_A

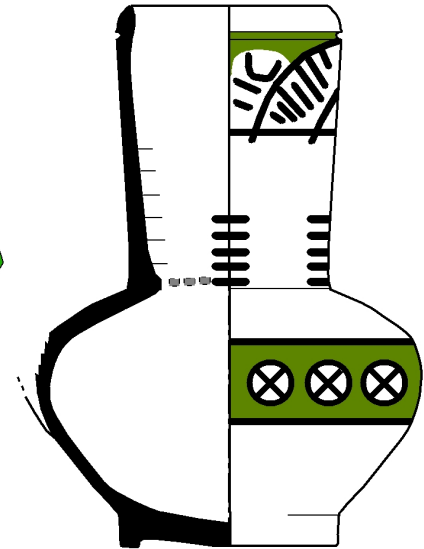
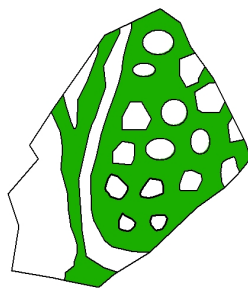

Nº 98.3 - 285778

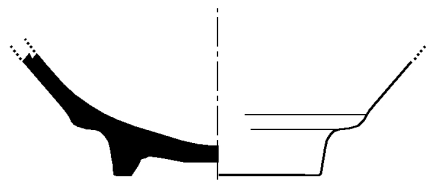

Nº 98.3 - 49.404 - UBR 60\_B



Nº 98.3 - 49.402 - Caja 45\_A

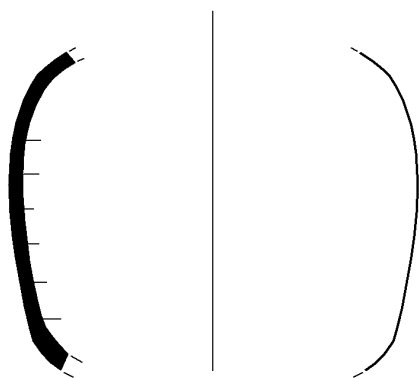

Nº 98.3 - 45.404 - UBR 404\_C

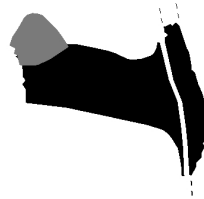

Nº 98.3 - 45.404 - UBR436E



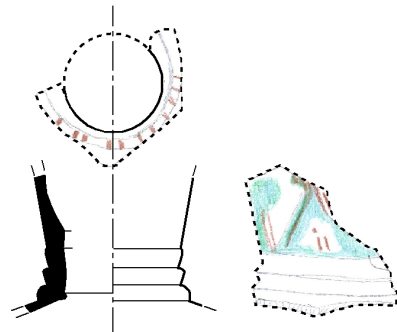

Nº 98.3 - 49.404 - 87C

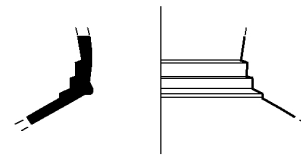

Nº 98.3 - 49.404 - CAJA 93\_B

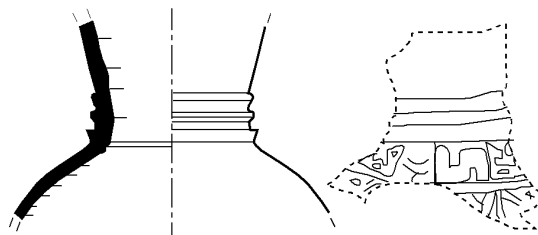

Nº 98.3 - 45.404 - UBR743A

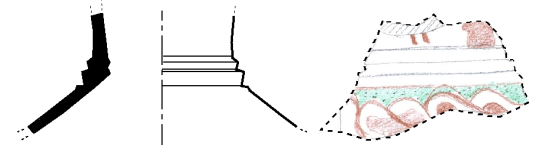

Nº 98.3 - 49.404 - 3U

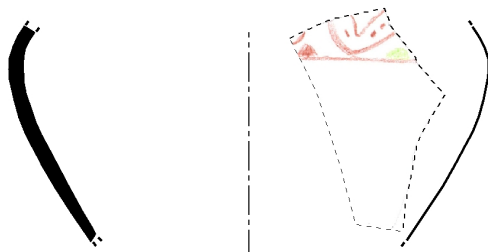

Nº 98.3 - 45.404 - UBR672F

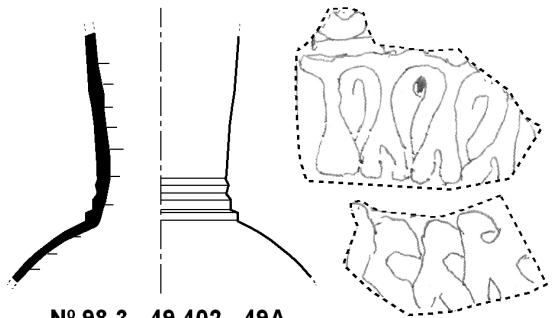

Nº 98.3 - 49.402 - 49A

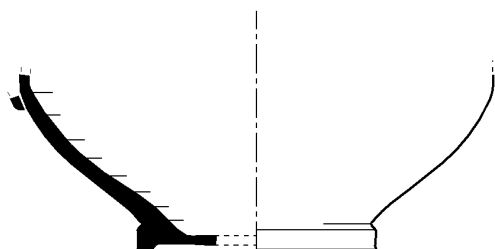

Nº 98.3 - 49.402 - Caja 7 pieza A



Nº 98.3 - 49.404 - 82F

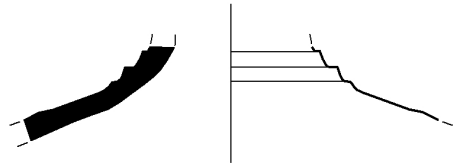

N° 98.3 - 45.404 - UBR 586\_A

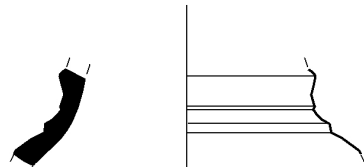

N° 98.3 - 49.404 - CAJA 74\_A

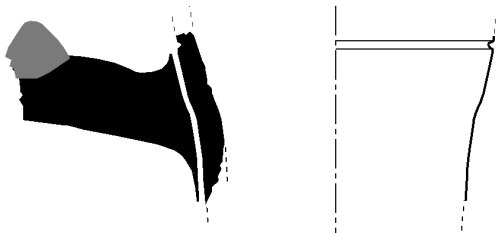

N° 98.3 - 45.404 - UBR436E

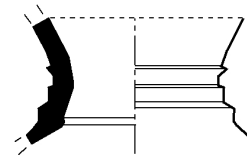

N° 98.3 - 49.402 - Caja 57C

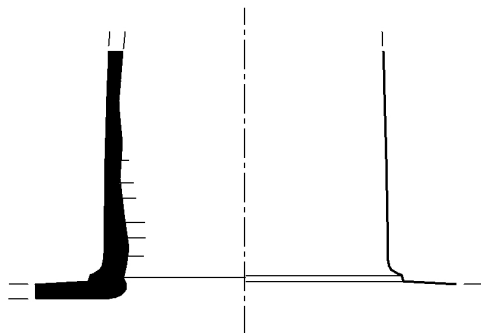

N° 98.3 - 49.402 - CAJA 50\_A

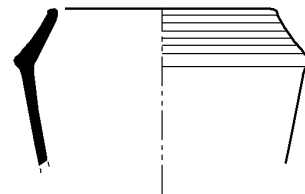

98.3 - 45.404 - UBR672C



N° 98.3 - 45.404 - UBR 404\_B

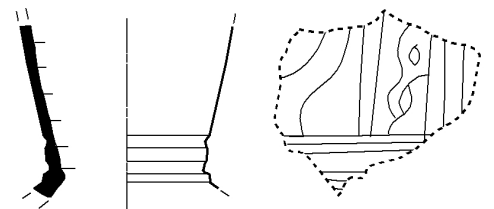

N° 98.3 - 45.404 - UBR 167A

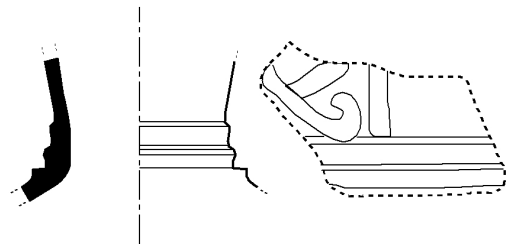

N° 98.3 - 45.404 - UBR882D

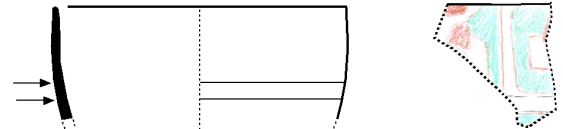

N° 98.3 - 49.404 - 67B

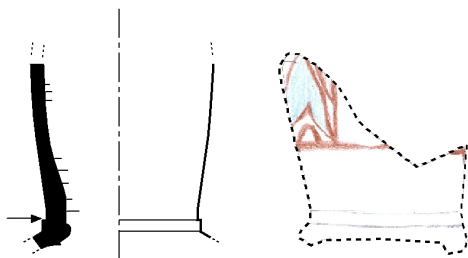

N° 98.3 - 45.404 - UBR 643

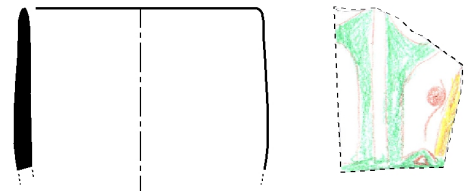

N° 98.3 - 49.404 - 92C

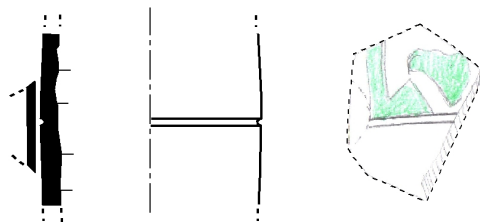

N° 98.3 - 45.404 - UBR672E

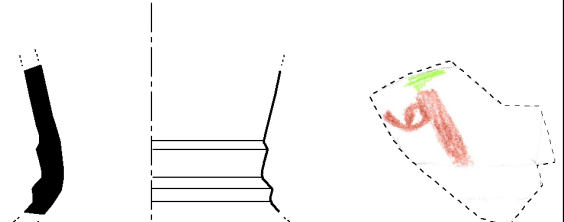

N° 98.3 - 45.404 - UBR849A

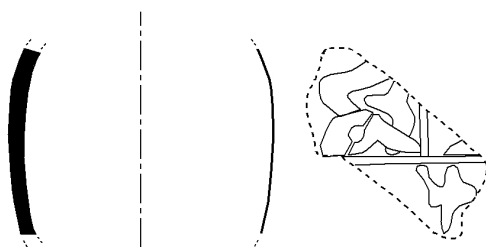

N° 98.3 - 45.404 - UBR773

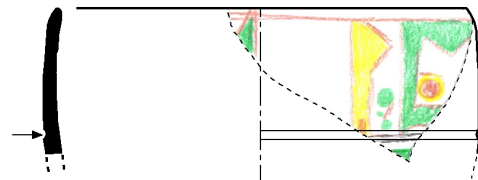

N° 98.3 - 49.404 - 84A

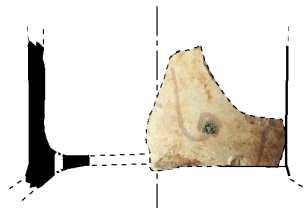

98.3 - 45.404 - UBR527A

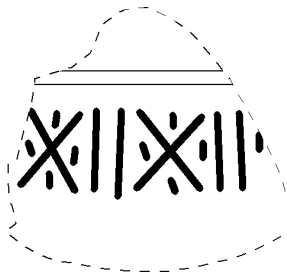

Nº 98.3 - SINUBR\_1B\_A

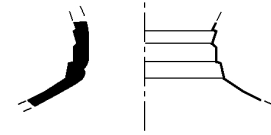

Nº 98.3 - 45.404 - UBR 624\_F

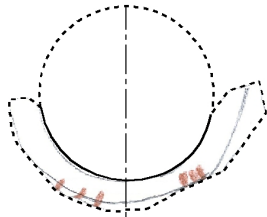

Nº 98.3 - 49.402 - CAJA 58G

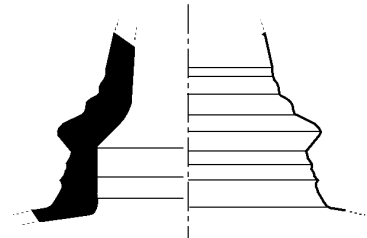
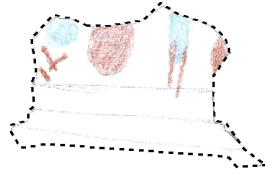

Nº 98.3 - 49.404 - 12A

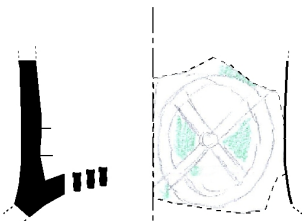

Nº 98.3 - 49.404 - 87D



Nº 98.3 - 45.404 - UBR708A



Nº 98.3 - 49.404 - 24A

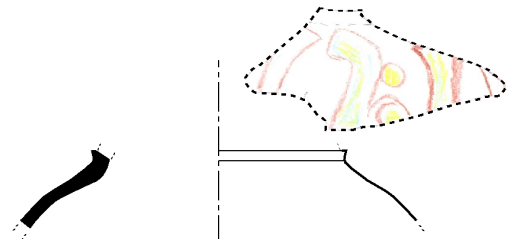
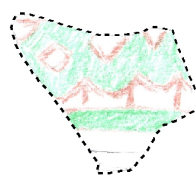

Nº 98.3 - 49.404 - 90A



Nº 98.3 - 45.404 - UBR 436\_A

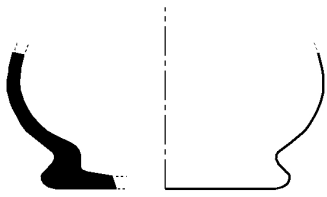

Nº 98.3 - 45.404 - UBR709A

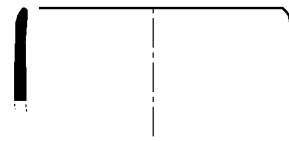
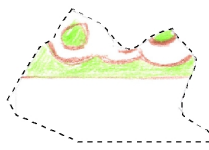

Nº 98.3 - 45.404 - UBR849D

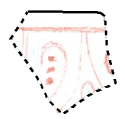

Nº 98.3 - 49.404 - 73C

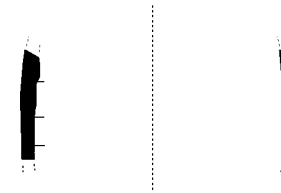
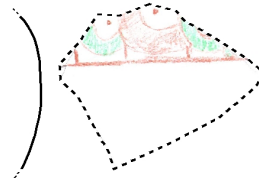

Nº 98.3 - 49.404 - 74B



Nº 98.3 - 49.404 - 75A

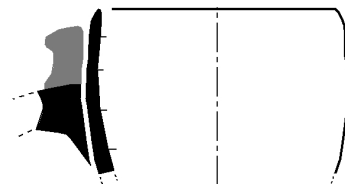
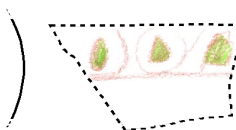

Nº 98.3 - 49.402 - 21A

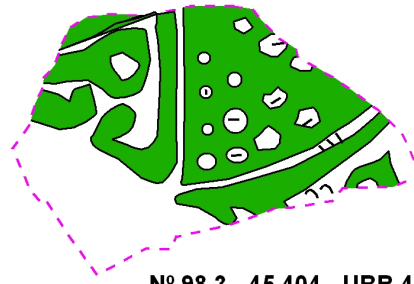

Nº 98.3 - 45.404 - UBR 436\_A

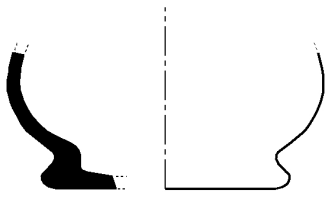

Nº 98.3 - 45.404 - UBR709A

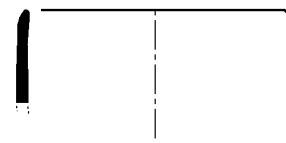
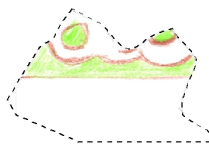

Nº 98.3 - 45.404 - UBR849D

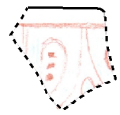

Nº 98.3 - 49.404 - 73C

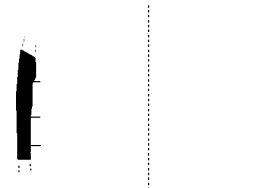
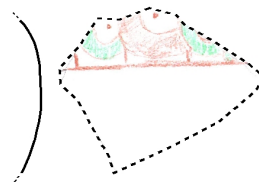

Nº 98.3 - 49.404 - 74B



Nº 98.3 - 49.404 - 75A

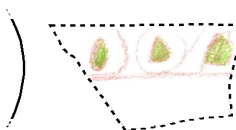

Nº 98.3 - 49.402 - 21A

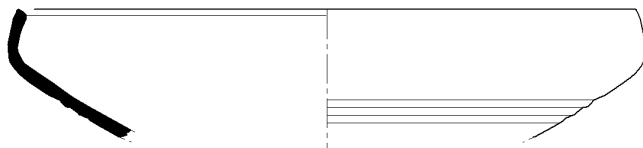

Nº 98.3 - 49.404 - UBR155A

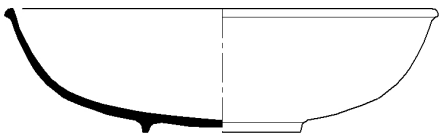

Nº 98.3 - 45.404 - UBR881A

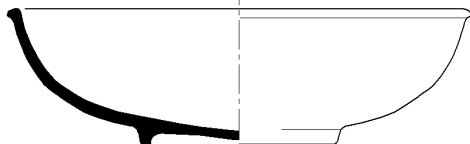
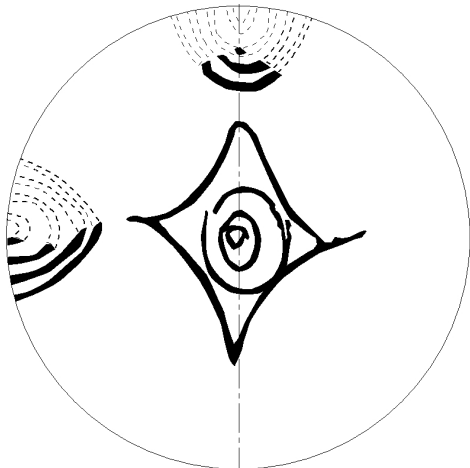

Nº 98.3 - 49.404 - 78B

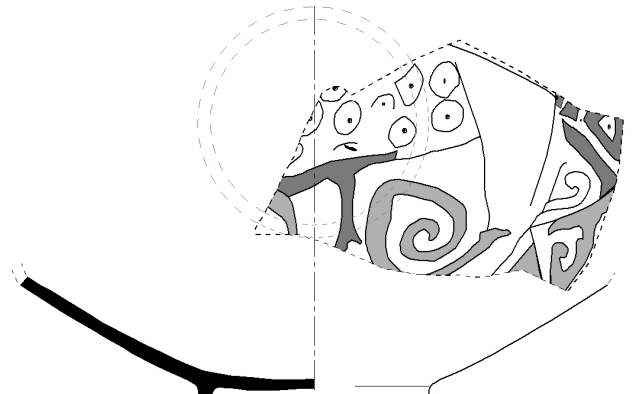

Nº 98.3 - 49.402 - 32A

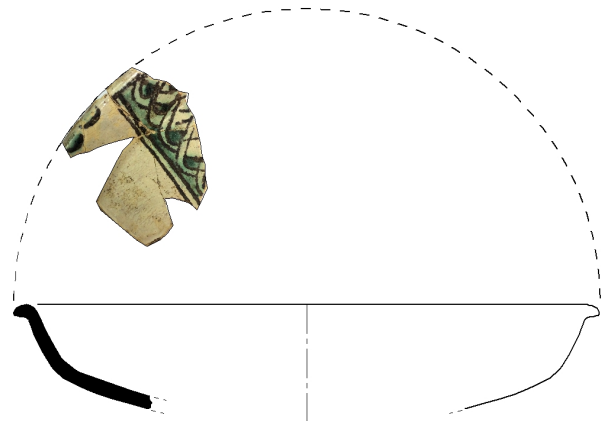

Nº 98.3 - 45.404 - UBR471C



98.3 - U.45.404 - UBR798A

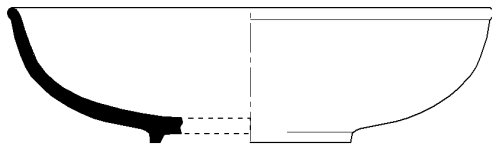

Nº 98.3 - 49.404 - UBR124\_A

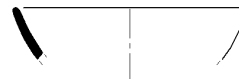

Nº 98.3 - 49.402 - 30A



Nº 98.3 - 49.402 - 28A



Nº 98.3 - 49.404 - UBR 243A



Nº 98.3 - 49.402 - Caja 58 pieza F

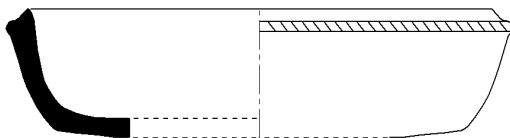

Nº 98.3 - 45.404 - UBR 671\_G



Nº 98.3 - 45.404 - UBR 709F

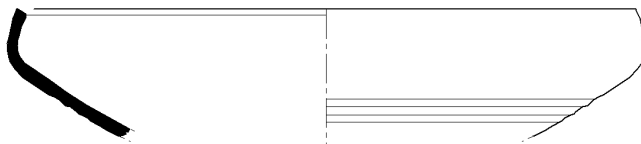

Nº 98.3 - 49.404 - UBR155A

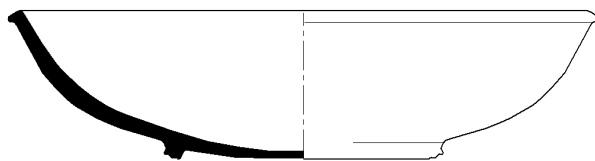
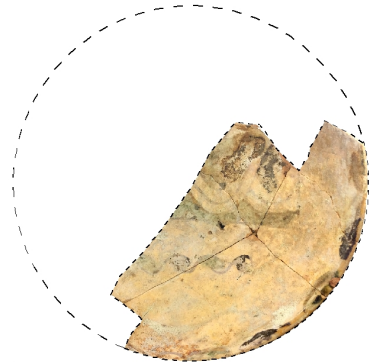

Nº 98.3 - 45.AI.412- UBR 863\_A



98.3 - 49.404 - UBR151A



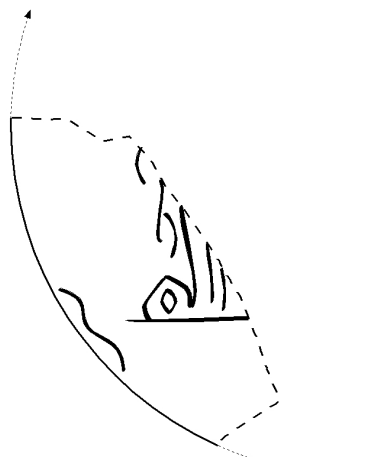

Nº 98.3 - 49.404 - UBR 211A



Nº 98.3 - 49.404 - UBR111B

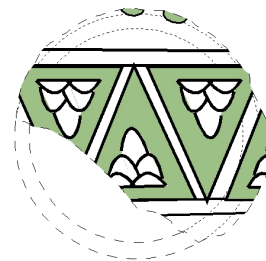

Nº 98.3 - 45.4a04 - UBR 465C

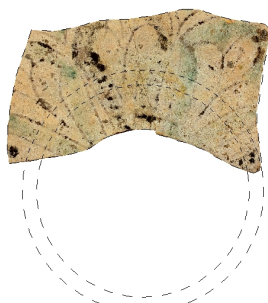

Nº 98.3 - 49.404 - UBR139B

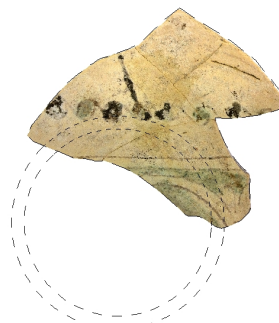

Nº 98.3 - 45.404 - UBR234B

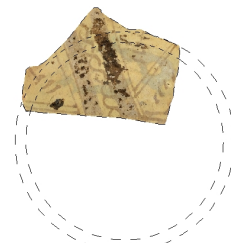

Nº 98.3 - 45.404 - UBR624E

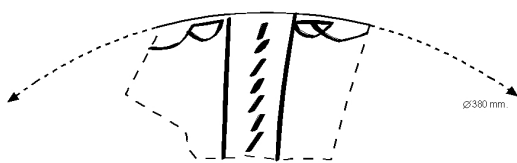

Nº 98.3 - 49.404 - UBR 211C

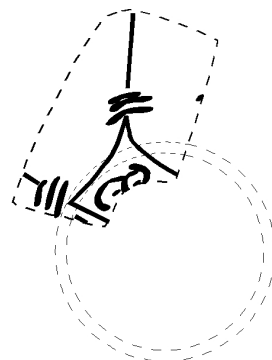
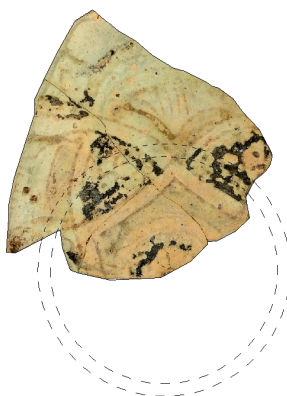

Nº 98.3 - 45.404 - UBR624A

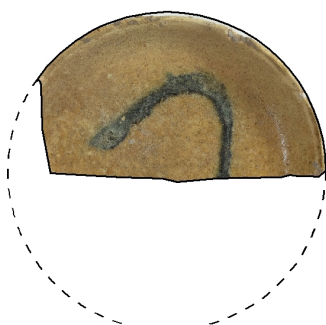

Nº 98.3 - 49.404 - 1G

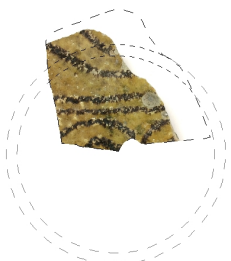

98.3 - U.49.404 - UBR233B

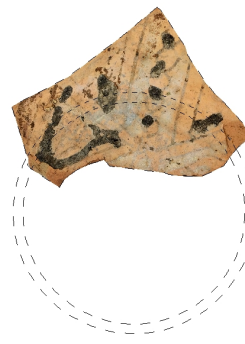

98.3 - 45.404 - UBR527E

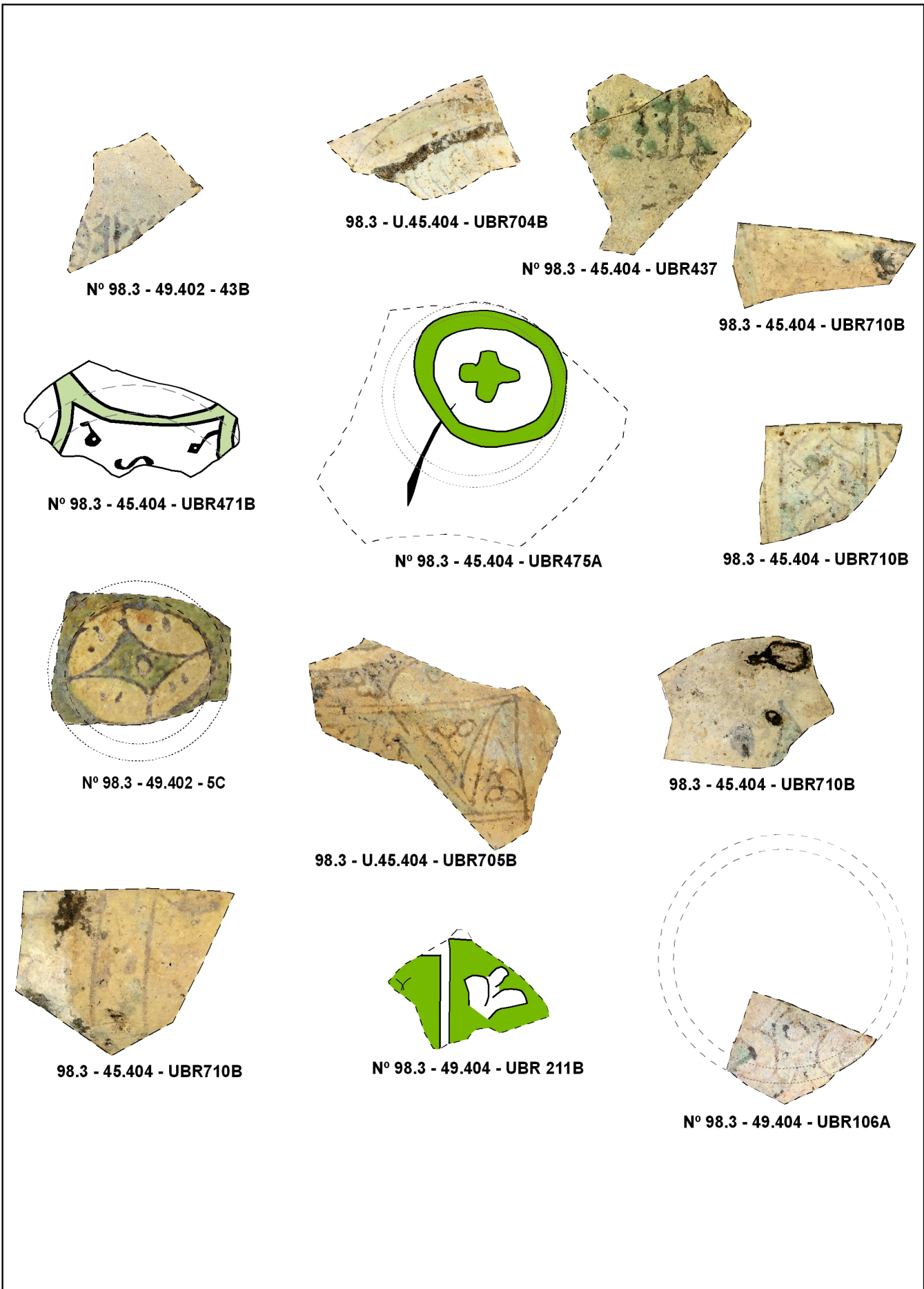

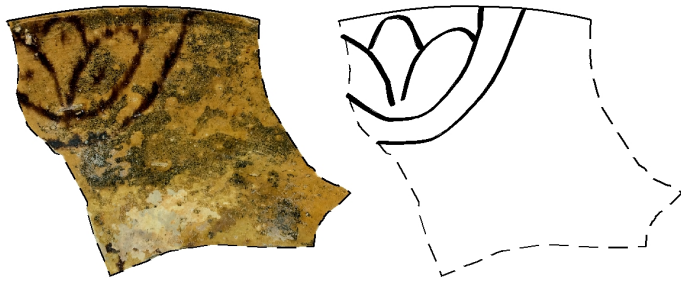

98.3 - U.45.404 - UBR785

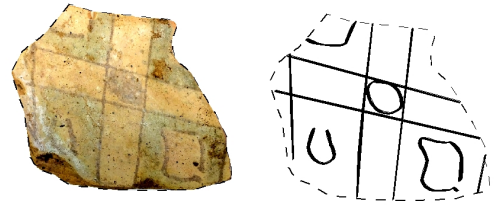

98.3 - U.45.404 - UBR772F

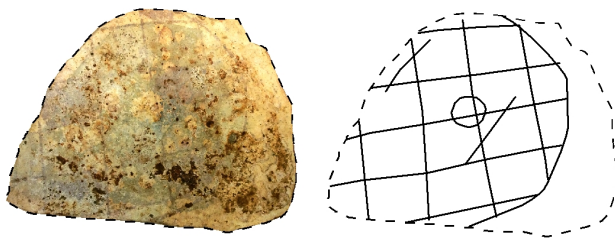

98.3 - U.45.404 - UBR882A



98.3 - 45.404 - UBR710B

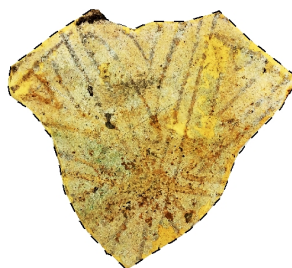
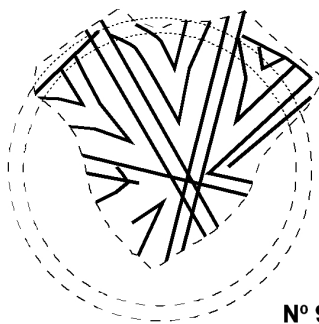

N° 98.3 - 49.404 - UBR168A

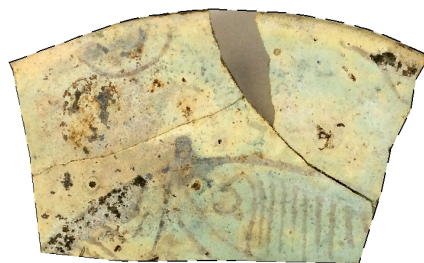

98.3 - 45.404 - UBR710B

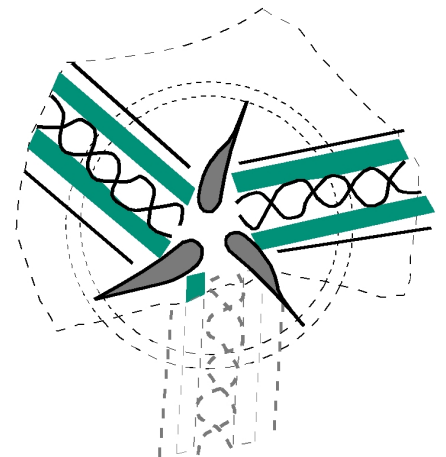

98.3 - U.45.404 - UBR705C

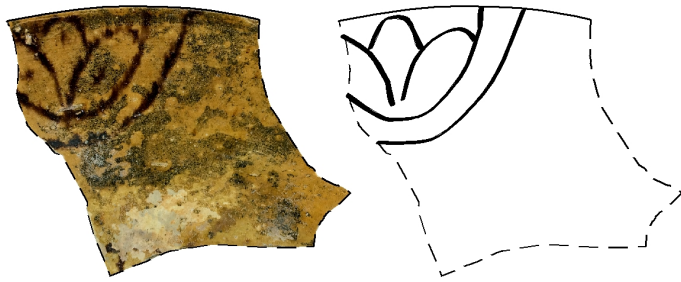

98.3 - U.45.404 - UBR785

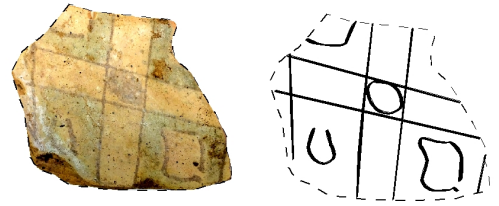

98.3 - U.45.404 - UBR772F

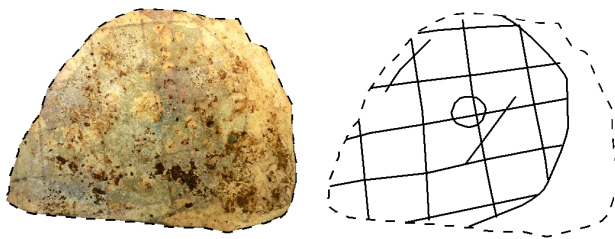

98.3 - U.45.404 - UBR882A

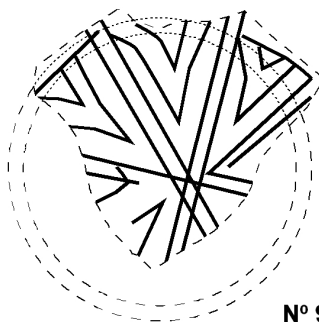

Nº 98.3 - 49.404 - UBR168A

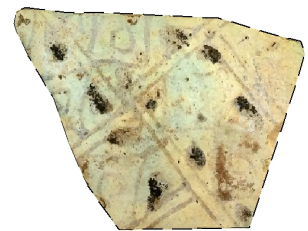
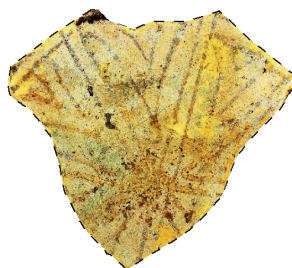

98.3 - 45.404 - UBR710B

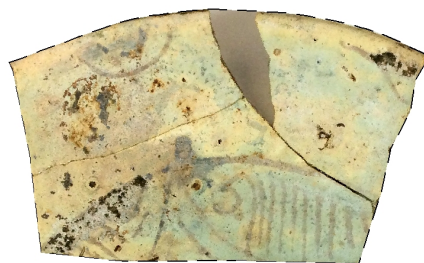

98.3 - 45.404 - UBR710B

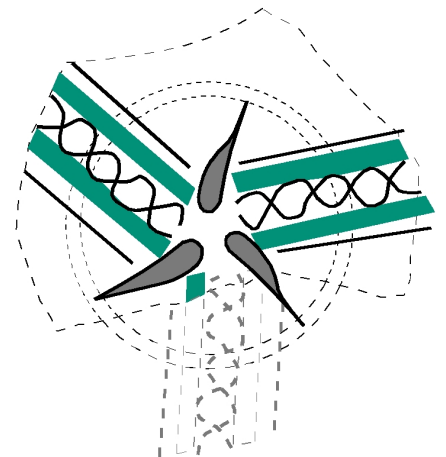

98.3 - U.45.404 - UBR705C

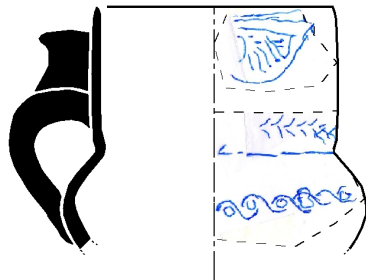

Nº 98.3 - 49.404 - 92A

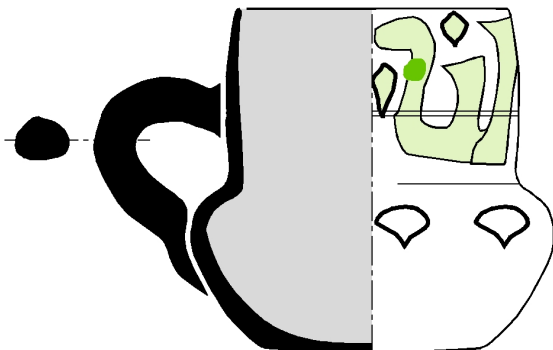
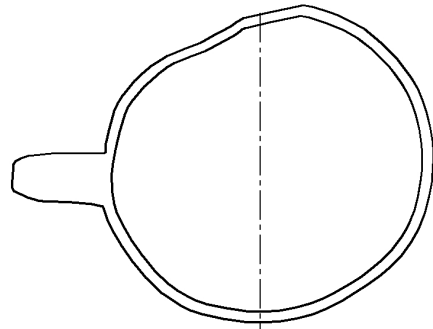

Nº 98.3 - 49.404 - UBR709C

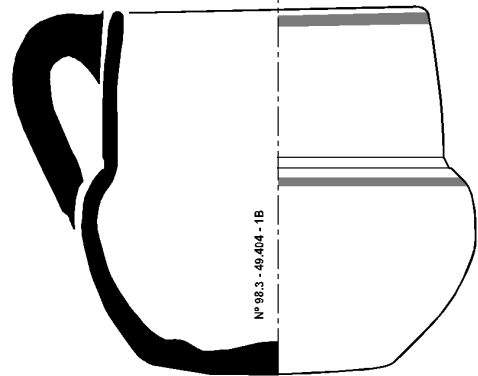

Nº 98.3 - 49.404 - 1B

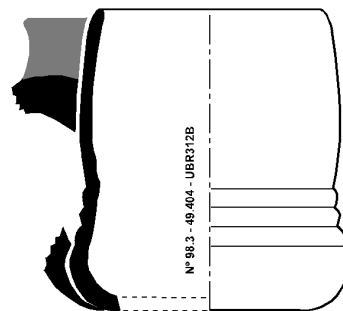

Nº 98.3 - 49.404 - UBR312B

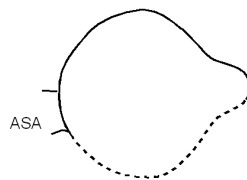

ASA

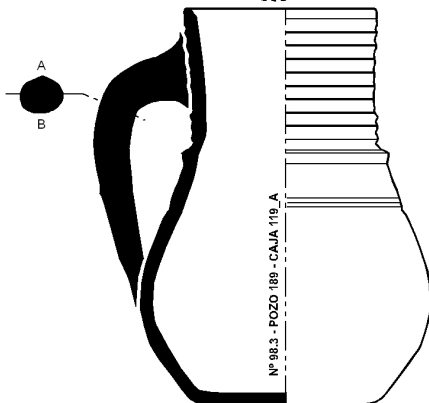

Nº 98.3 - POZO 189 - CAJA 119\_A

A  
B

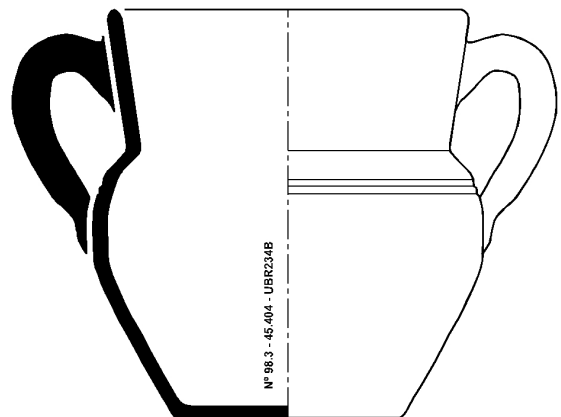

Nº 98.3 - 49.404 - UBR234B





Nº 98.3 - 49.404 - 67C

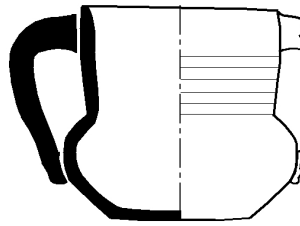

98.3 - 45.404 - UBR754

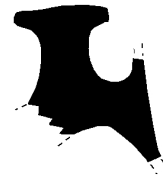

Nº 98.3 - 49.402 - 58A

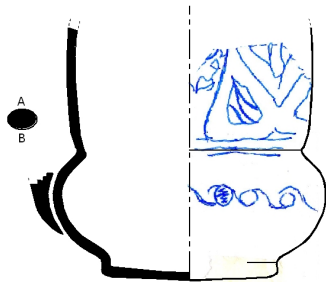

Nº 98.3 - 45.404 - UBR800

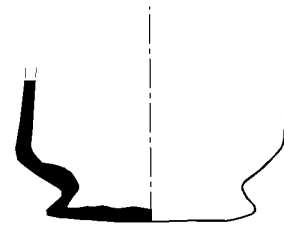

Nº 98.3 - 45.404 - UBR710E

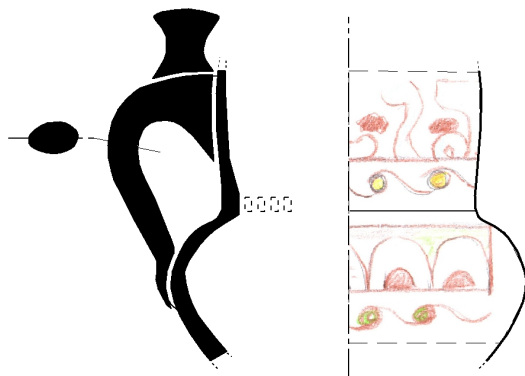

Nº 98.3 - 49.404 - 80A

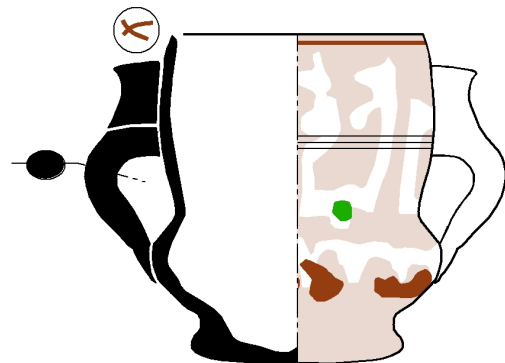

Nº 98.3 - 49.404 - 79B

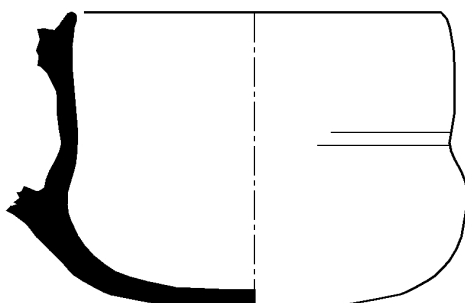

Nº 98.3 - 49.404 - 3B

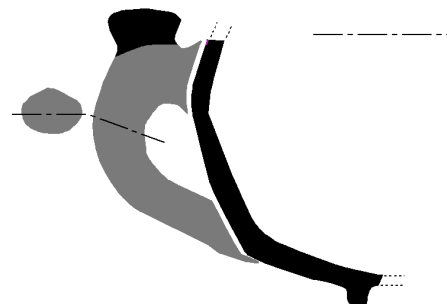

Nº 98.3 - 49.404 - 92D



Nº 98.3 - 49.404 - UBR 772B

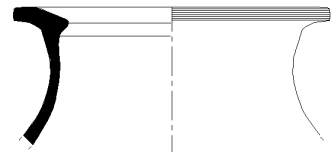

Nº 98.3 - 45.404 - UBR 673C

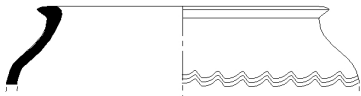

Nº 98.3 - 45.404 - UBR 786A



98.3 - 45.404 - UBR527B

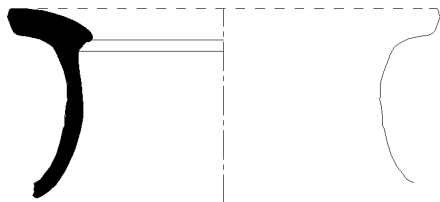

Nº 98.3 - 49.402 - 27B

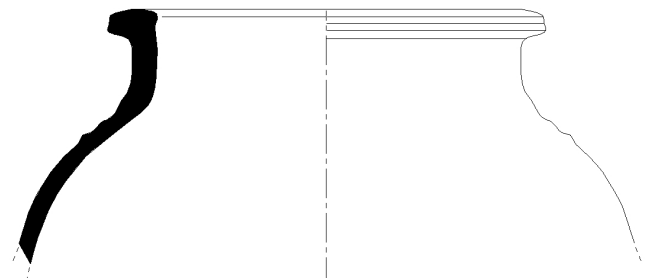

Nº 98.3 - 49.402 - 27A

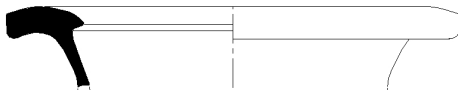

Nº 98.3 - 45.404 - UBR441A

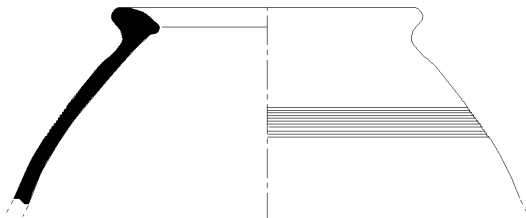

Nº 98.3 - 49.404 - 77C



Nº 98.3 - 49.402 - 56D

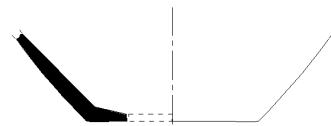

Nº 98.3 - 49.404 - CAJA 70A



Nº 98.3 - 45.404 - UBR 849E

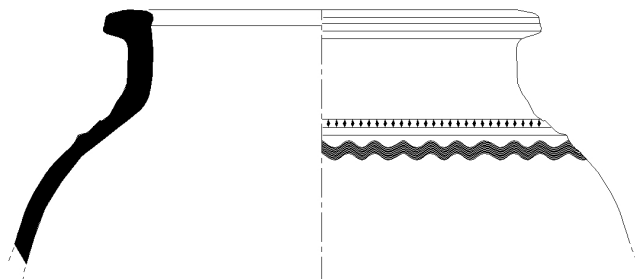

Nº 98.3 - 49.402 - 27A

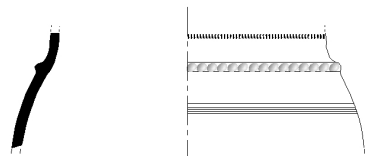

Nº 98.3 - 49.404 - 2F

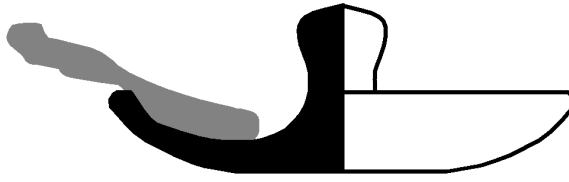

Nº 98.3 - 49.404 - CAJA 62\_C

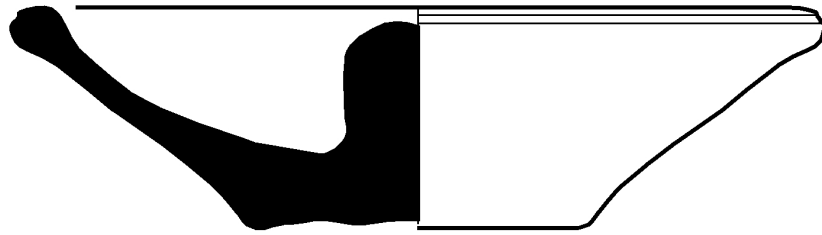

Nº 98.3 - 45.404 - UBR435C

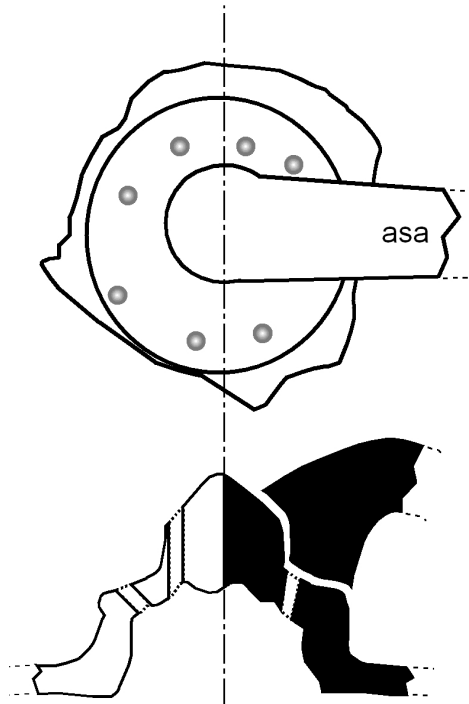

Nº 98.3 - 49.402 - MUESTRA 5

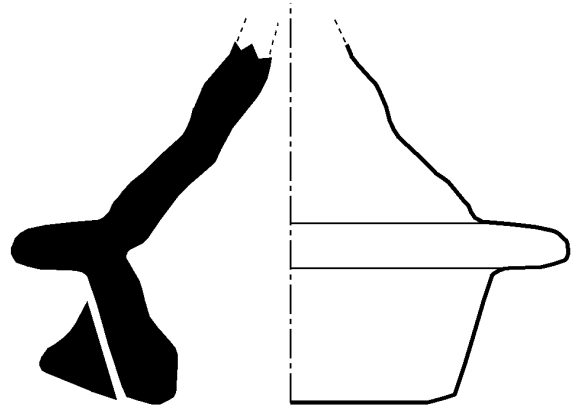

Nº 98.3 - 49.402 - Caja 8 pieza A



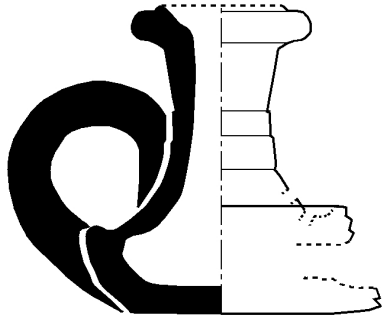

Nº 98.3 - 49.402 - CAJA 56 PIEZA C

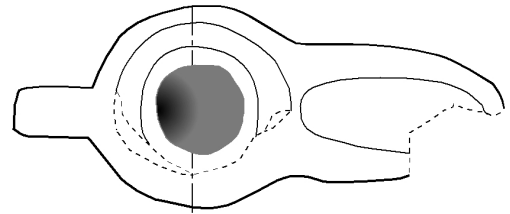

Nº 98.3 - 49.404 - UBR40C

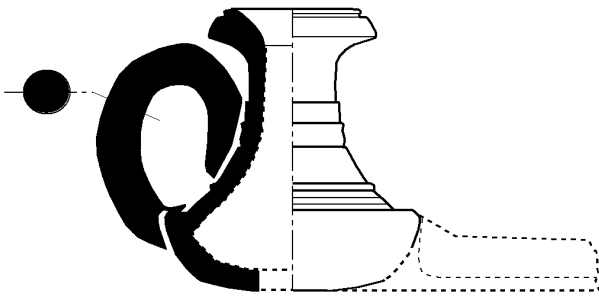

98.3 - 49.404 - UBR313

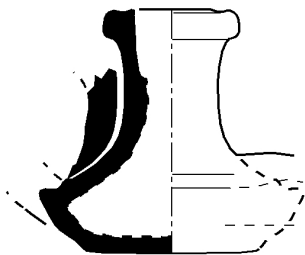
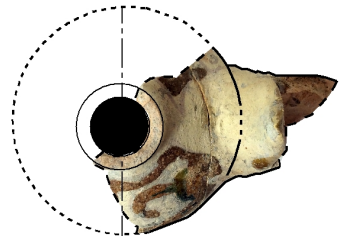

Nº 98.3 - 6/G - 271433

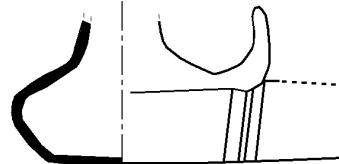

Nº 98.3 - 49.404 - 4U

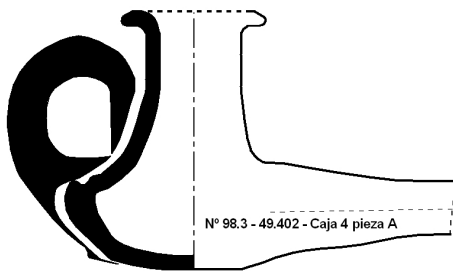

Nº 98.3 - 49.402 - Caja 4 pieza A

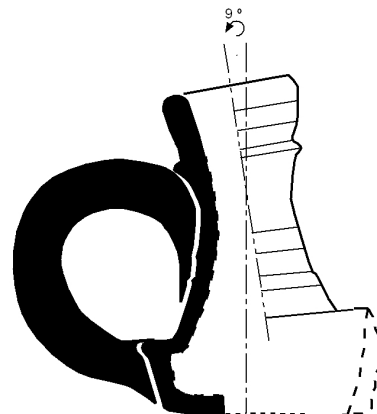

Nº 98.3 - 12.14/DE - 271429

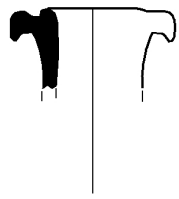

Nº 98.3 - 49.404 - CAJA 77\_D

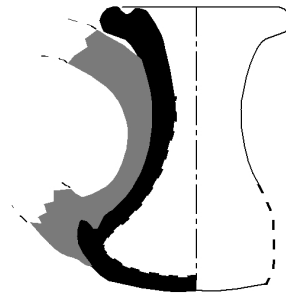

Nº 98.3 - 4/G - 271432

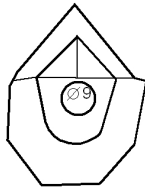
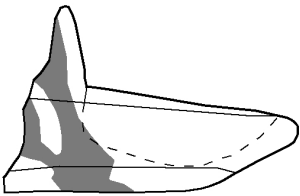
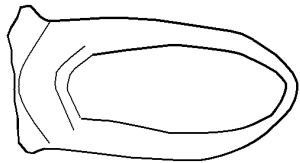

Nº 98.3 - 45.404 - UBR438

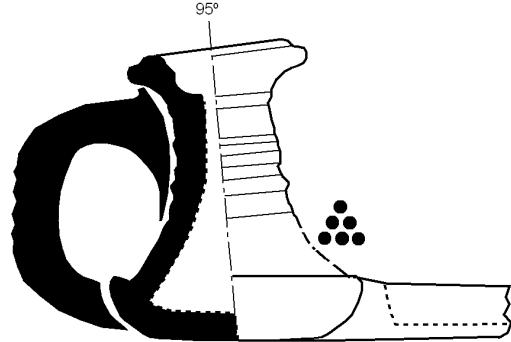
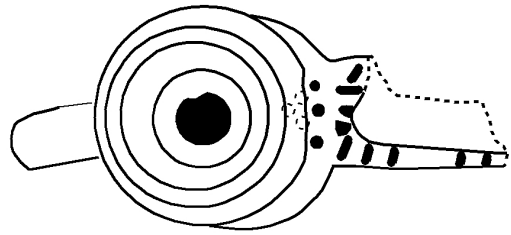

98.3 - 45.404 - UBR550

Nº 98.3 - 43.81 - UBR 393 A

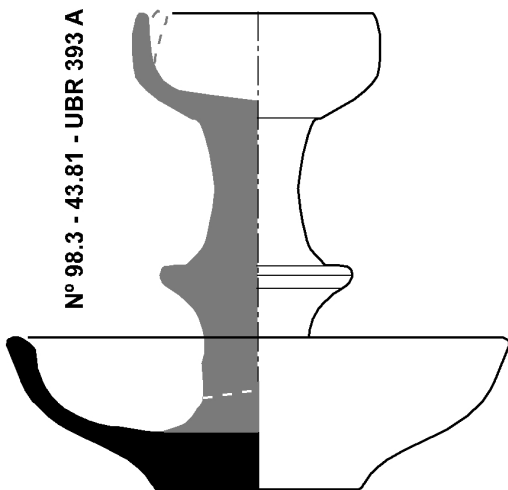

Nº 98.3 - 45.404 - UBR404G

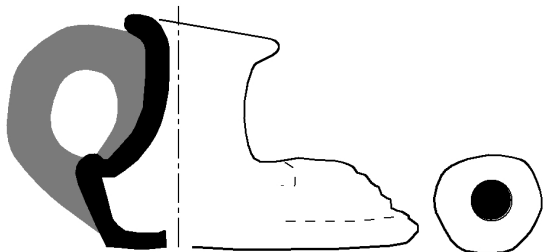
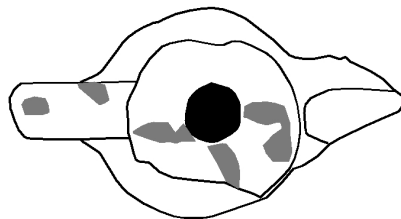

Nº 98.3 - 45.404 - UBR440

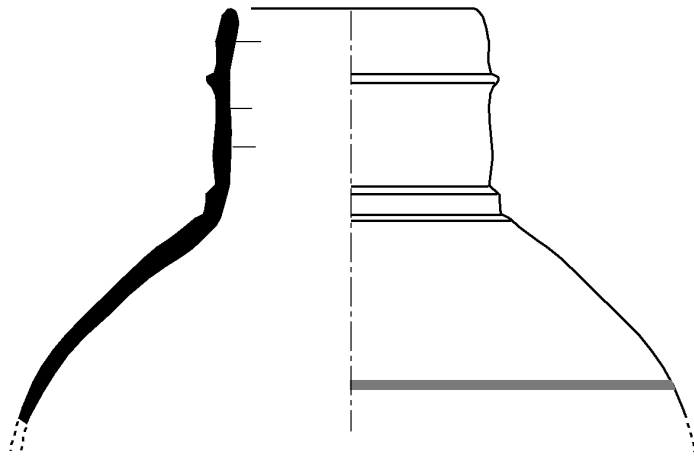

Nº 98.3 - 45.404 - UBR777A

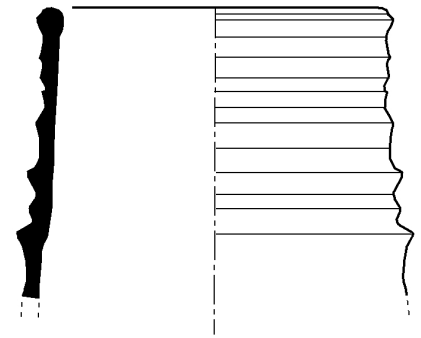

Nº 98.3 - 49.404 - UBR278A+UBR167

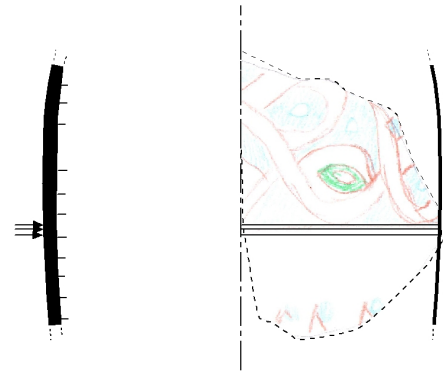

Nº 98.3 - 49.404 - 90C

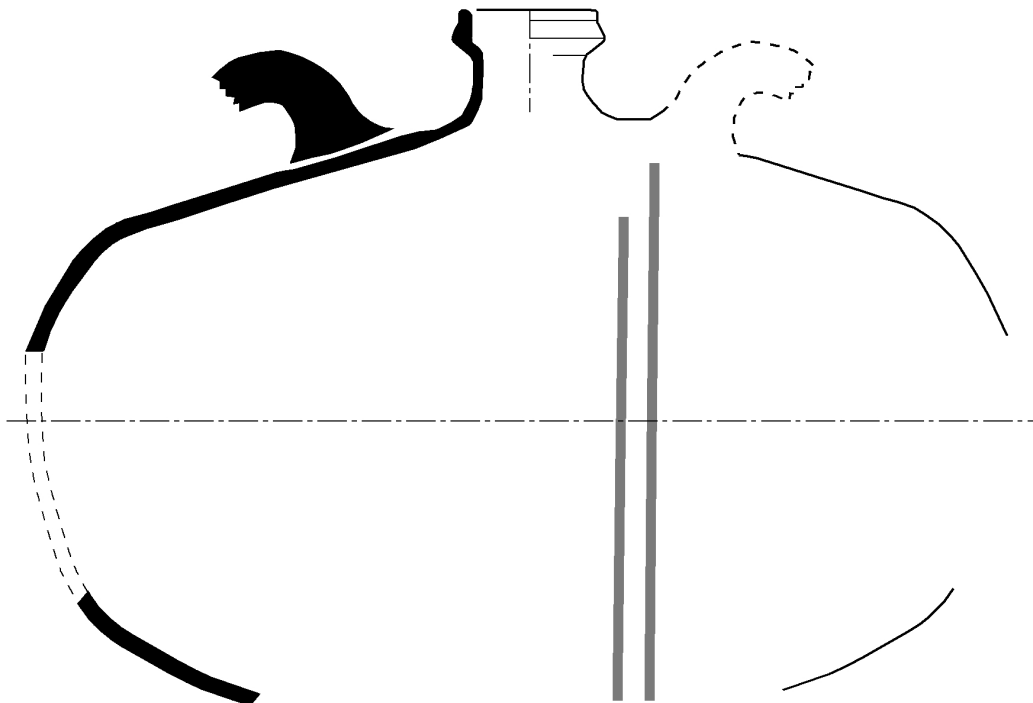

Nº 98.3 - SINUBR\_1C\_A

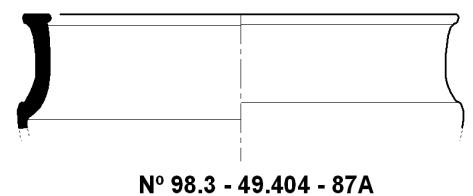
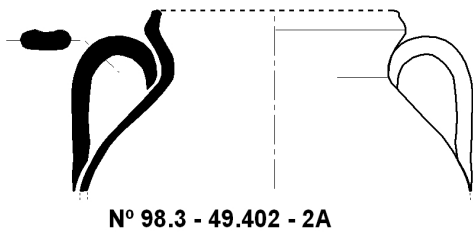
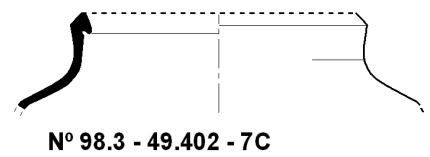
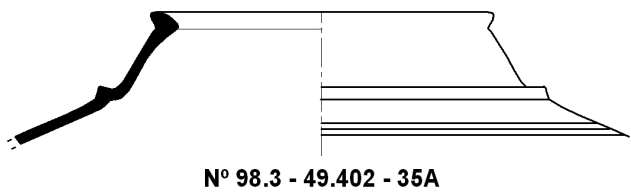
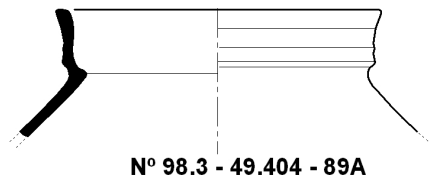
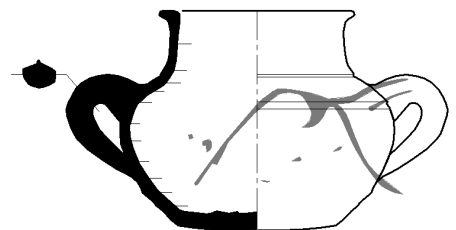
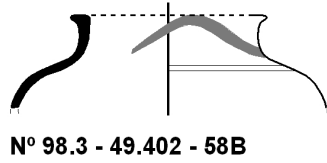
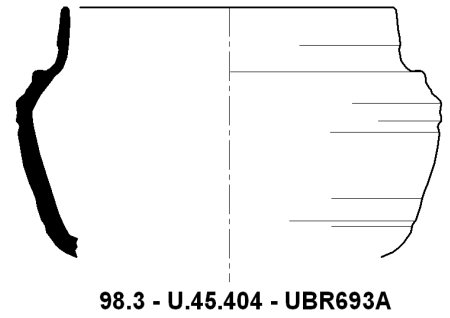
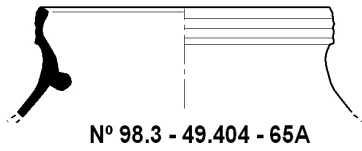
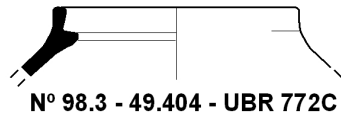

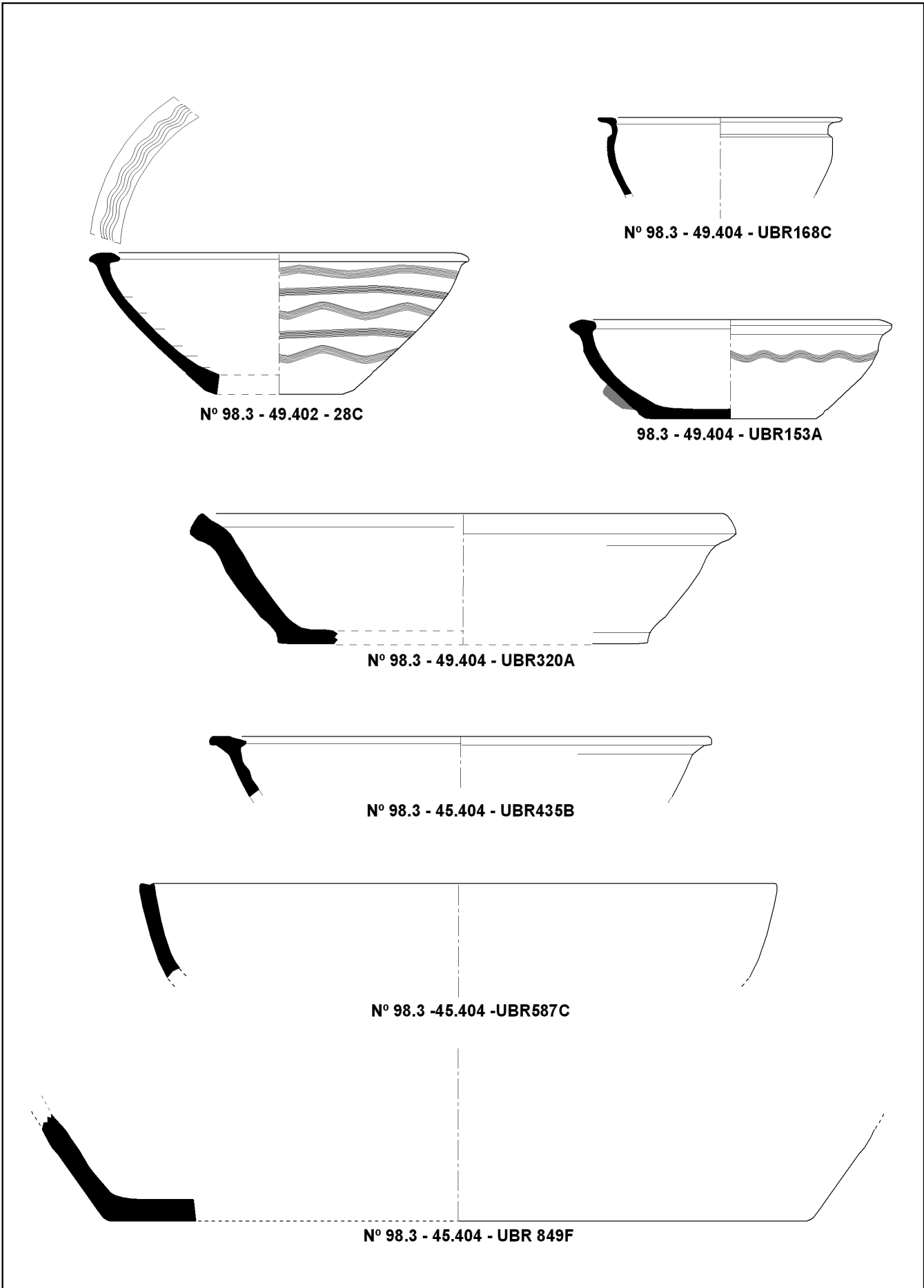

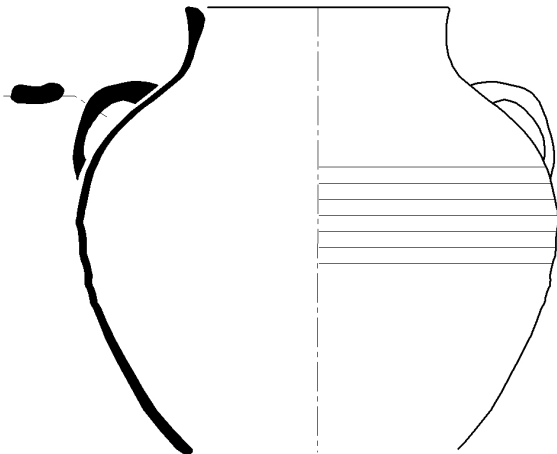

Nº 98.3 - 49.404 - UBR 281

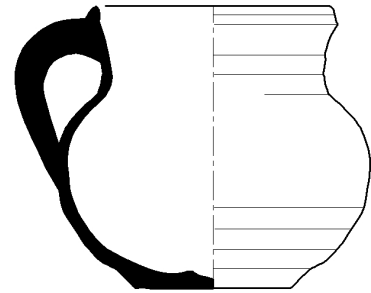

Nº 98.3 - 49.404 - UBR111D

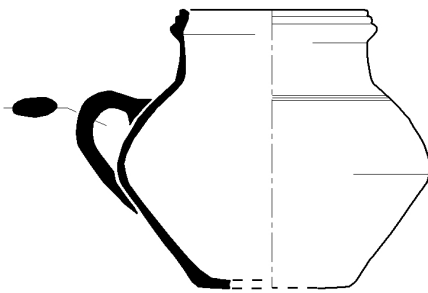

Nº 98.3 - 49.404 - 74C

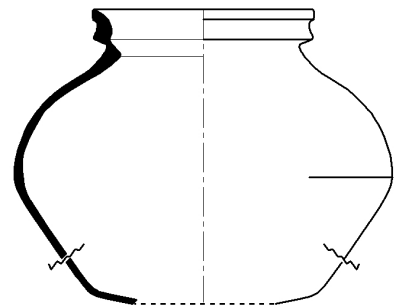

Nº 98.3 - 45.404 - UBR 755A

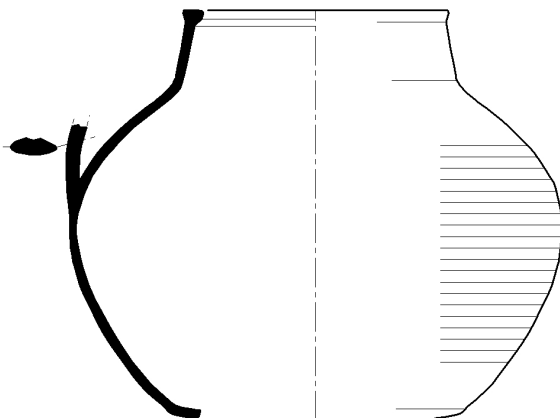

Nº 98.3 - 49.402 - 23B

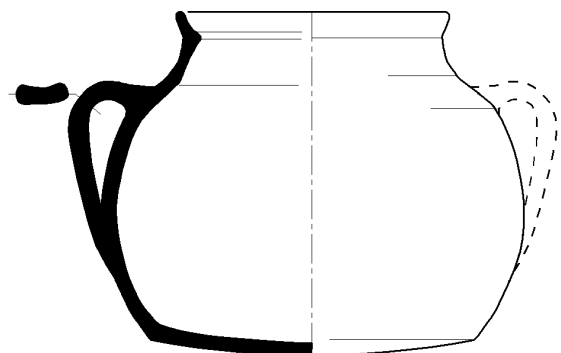

Nº 98.3 - 49.404 - 74E

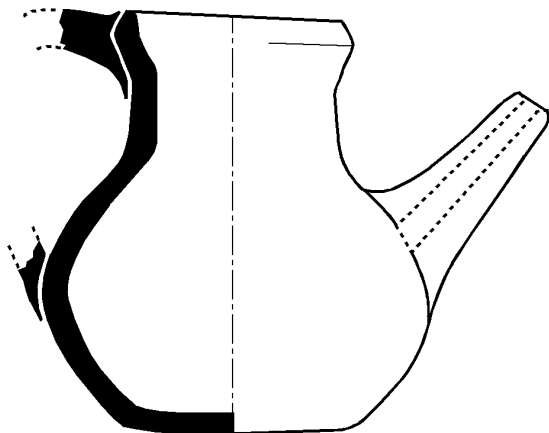

Nº 98.3 - 49.404 - UBR 286A

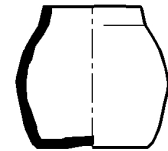

Nº 98.3 - 49.404 - UBR 246A

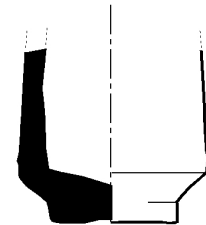

Nº 98.3 - 49.404 - UBR 41 B

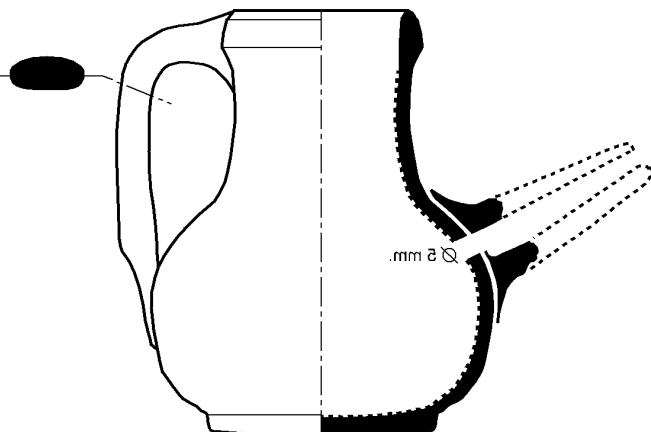

98.3 - 45.404 - UBR714

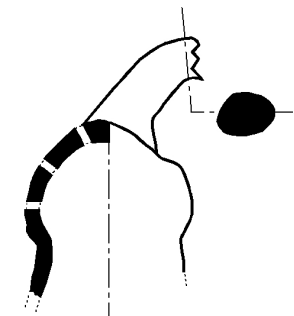

98.3 - 45.404 - UBR500

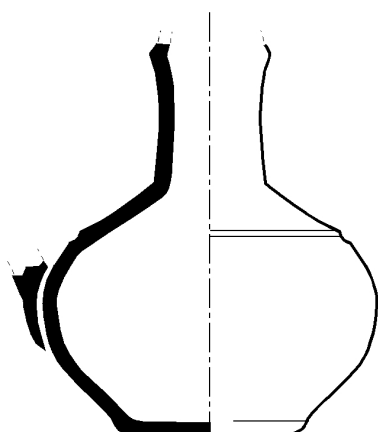

Nº 98.3 - 49.404 - UBR 241 A

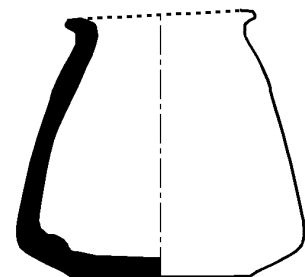

Nº 98.3 - 49.402 - 63F

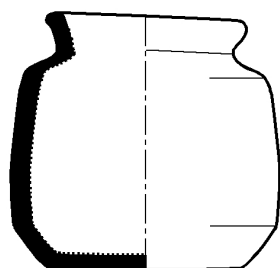

Nº 98.3 - 49.404 - UBR285A

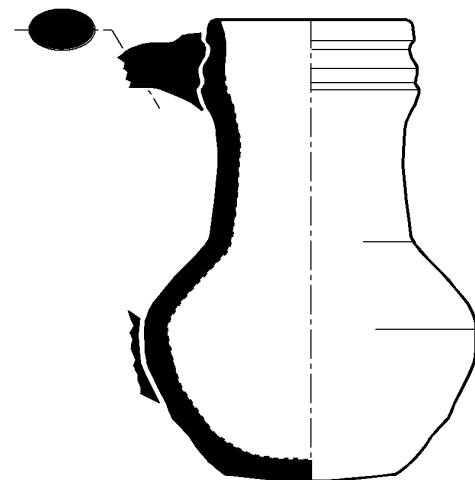

98.3 - 45.404 - UBR744

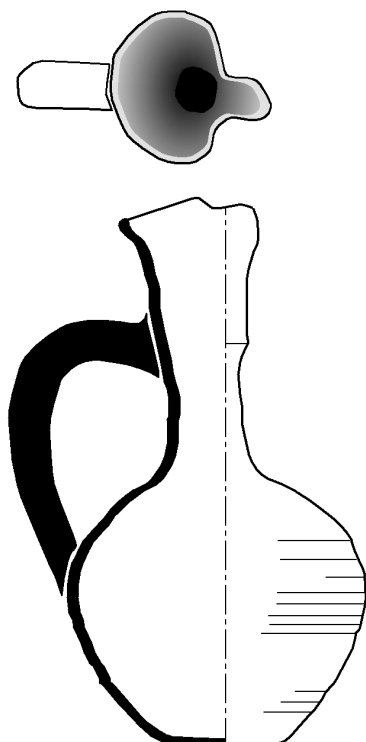

Nº 98.3 - U.45.404 - UBR699

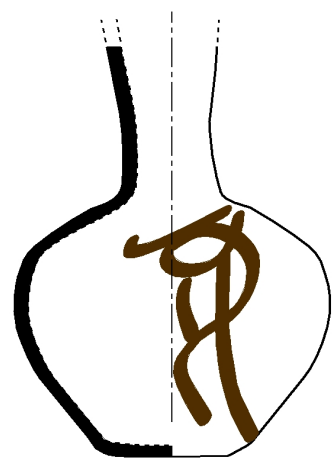

Nº 98.3 - 45.404 - UBR680A

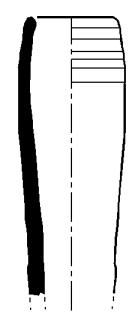

Nº 98.3 - 49.404 - UBR142

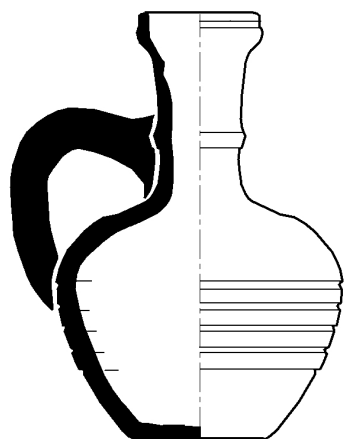

Nº 98.3 - 49.404 - UBR312A



98.3 - 6.8/F.G - PRESIGLADA2

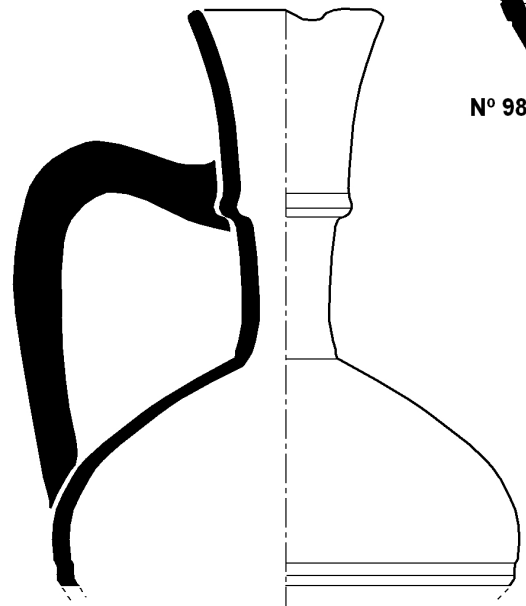

Nº 98.3 - 45.404 - UBR436B

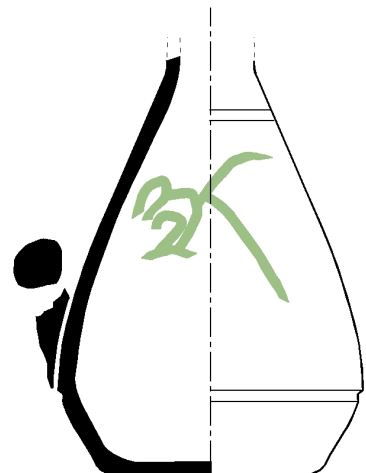

Nº 98.3 - 45.404 - UBR 414



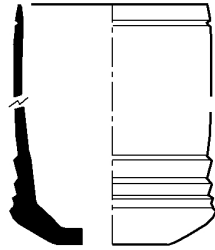

Nº 98.3 - 49.404 - CAJA 92\_B

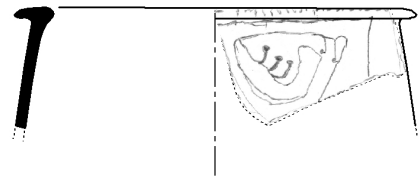

Nº 98.3 - 49.404 - 54A

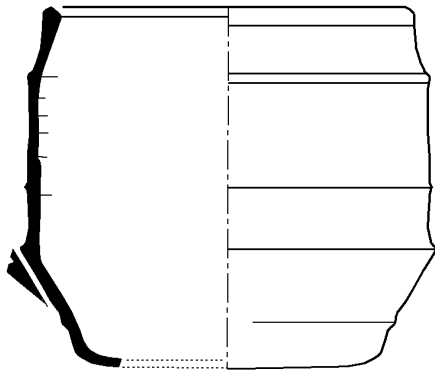

Nº 98.3 - 45.404 - UBR 678A

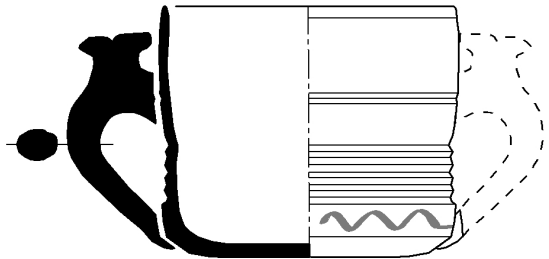

Nº 98.3 - 45.404 - UBR710F

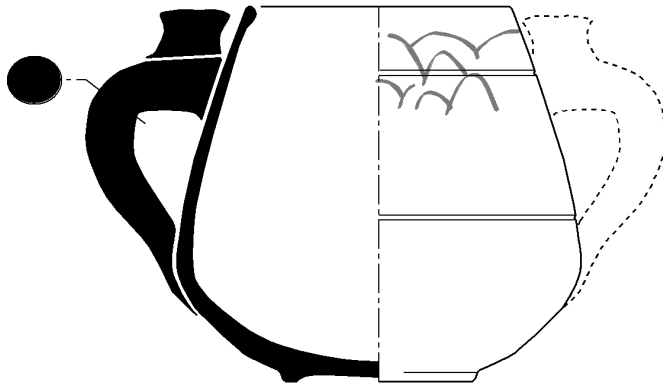

Nº 98.3 - 45.404 - UBR624B

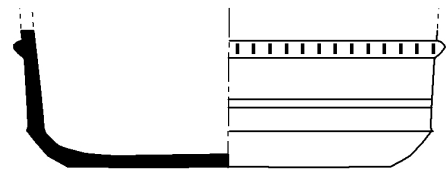

Nº 98.3 - 45.404 - UBR752A

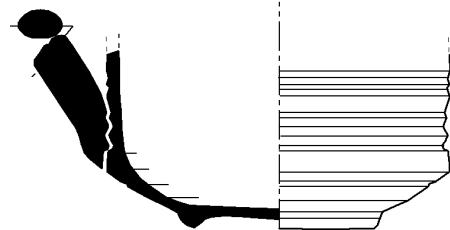

Nº 98.3 - 45.404 - UBR538A

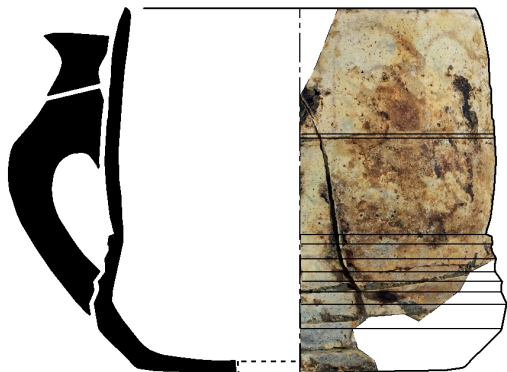

Nº 98.3 - 49.404 - 75K



Nº 98.3 - 49.402 - 56A



LÁMINA BALSETA

ESCALA: 5 cm.



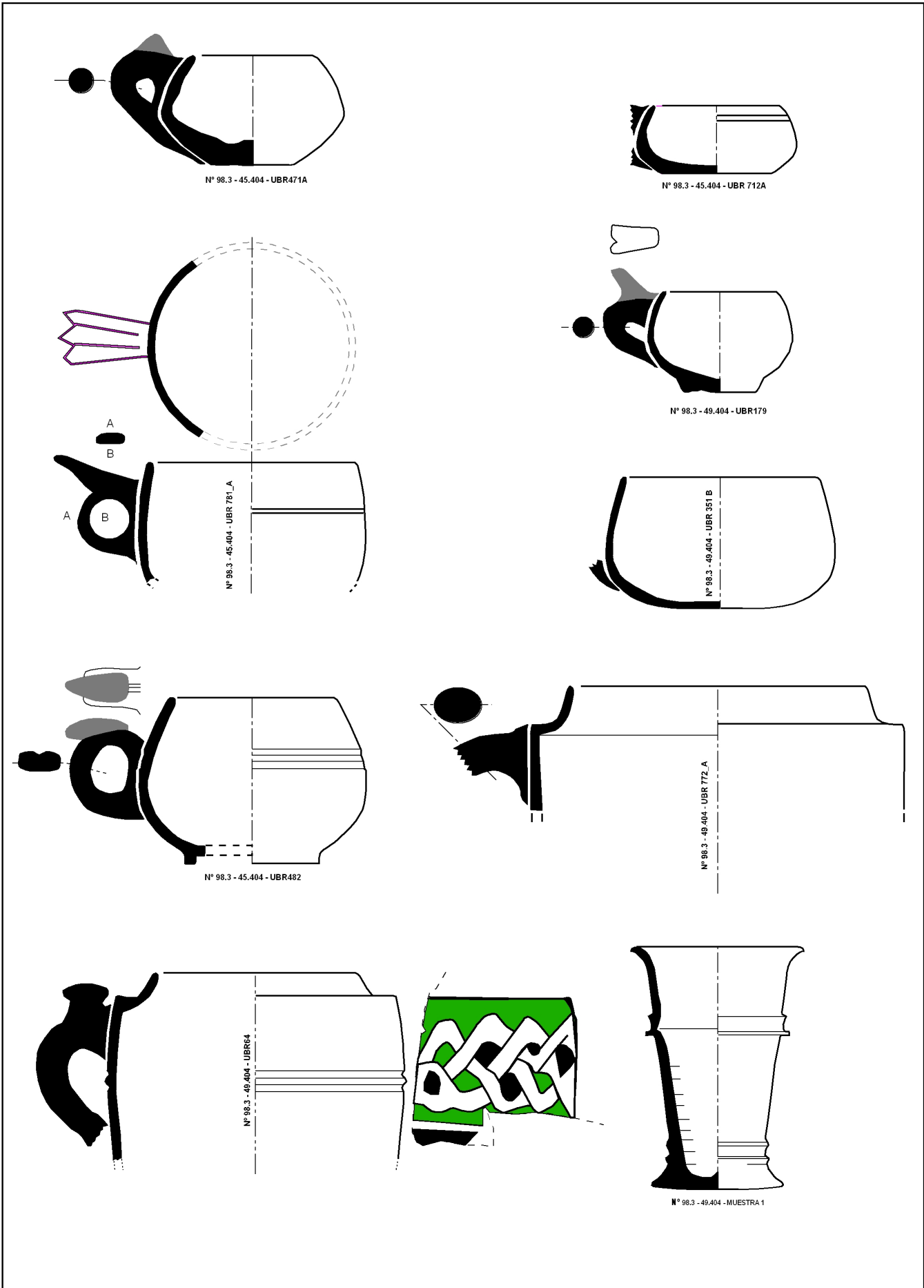
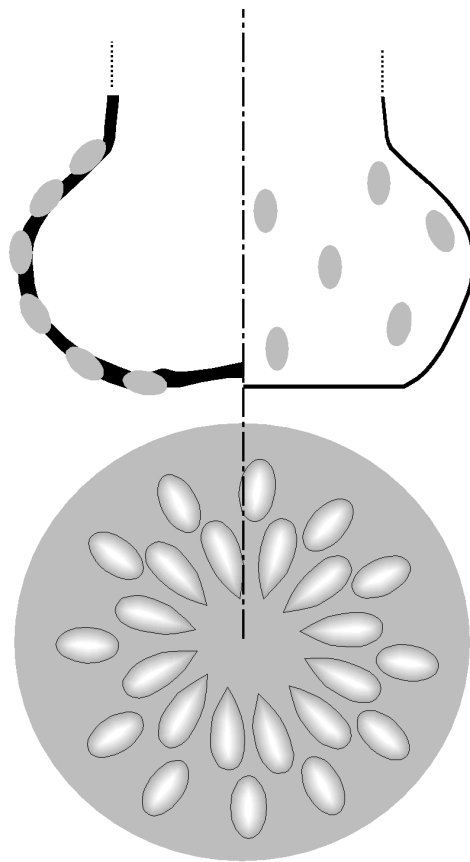

98.3 - U.49.404 - VIDRIO GOTAS

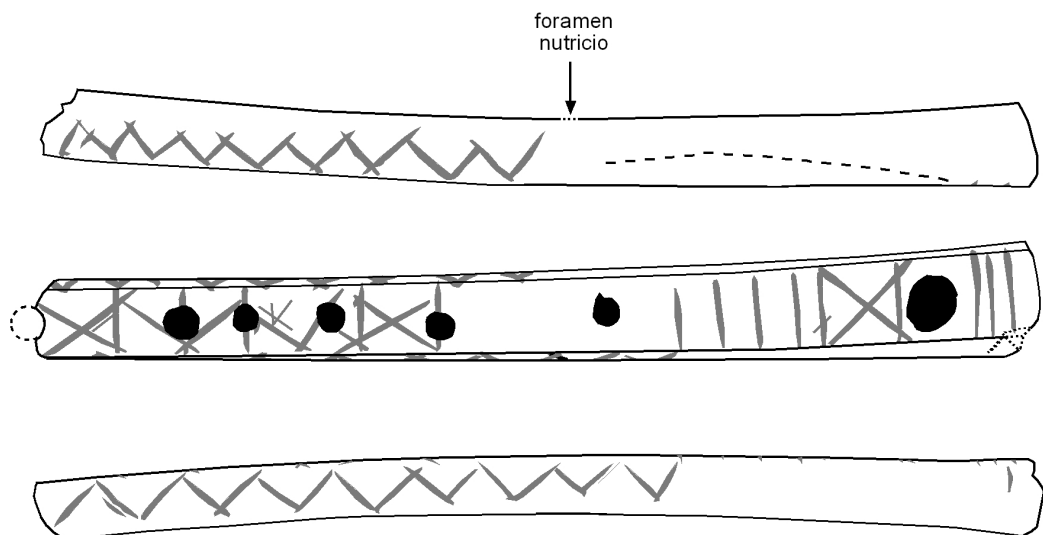

Nº 98.3 - 10.12/FG - 271441

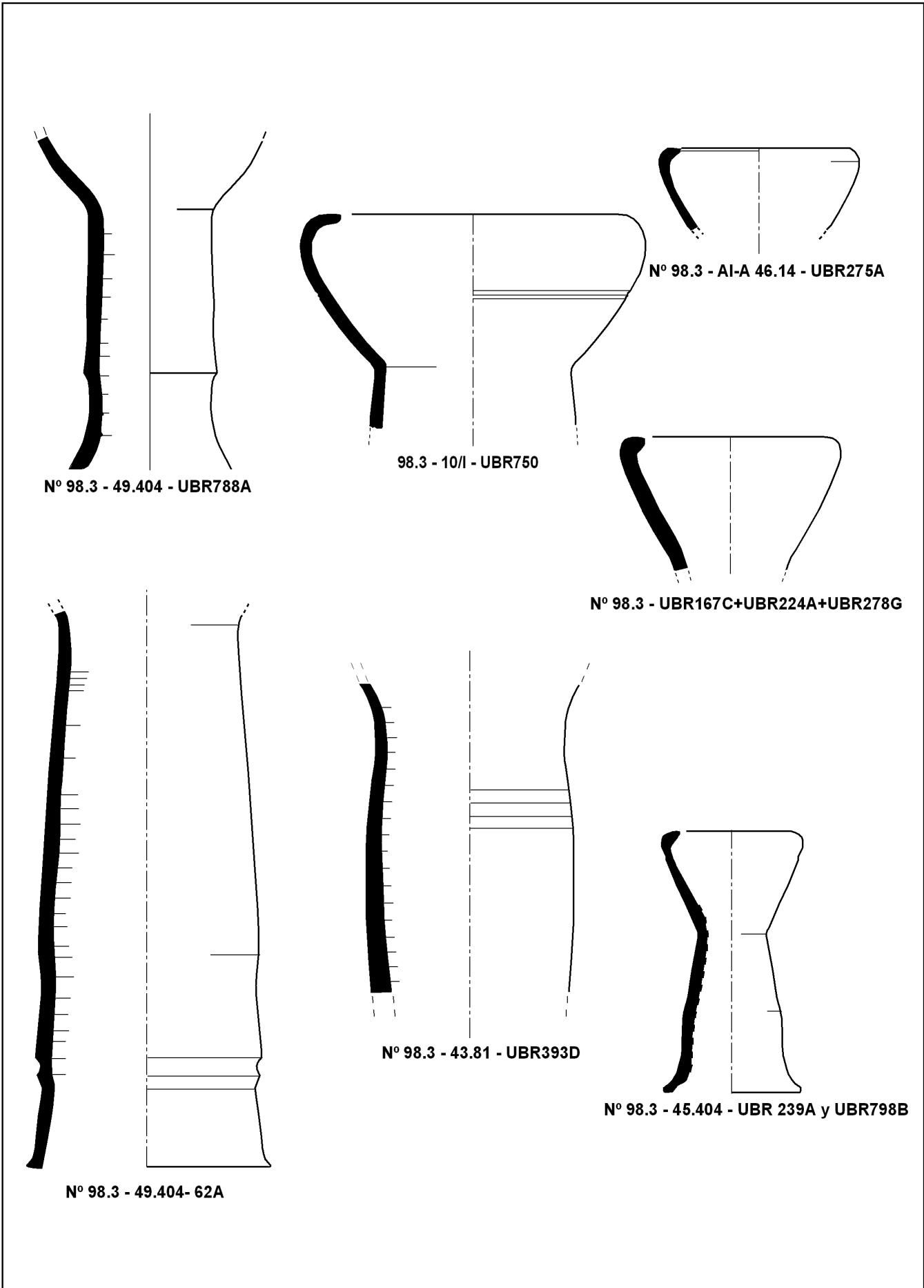

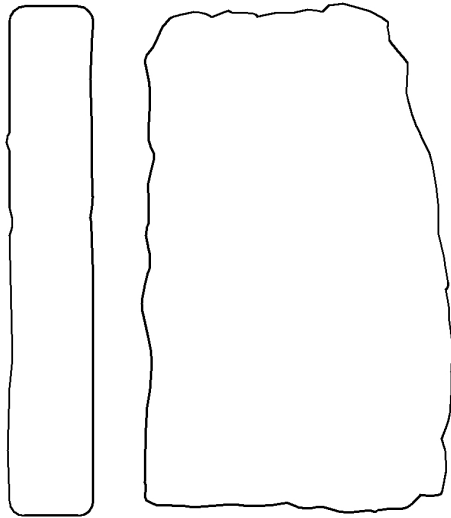

98.3 - 45.404 - UBR527G

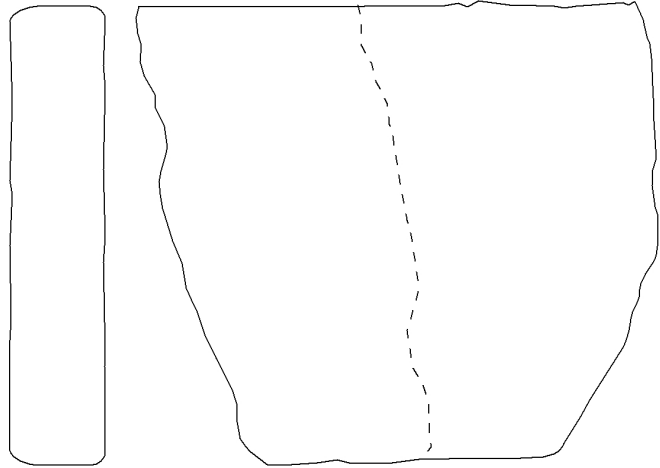

98.3 - 45.404 - UBR527F

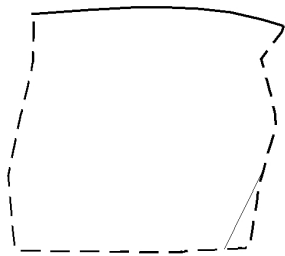

98.3 - U.45.404 - UBR671D

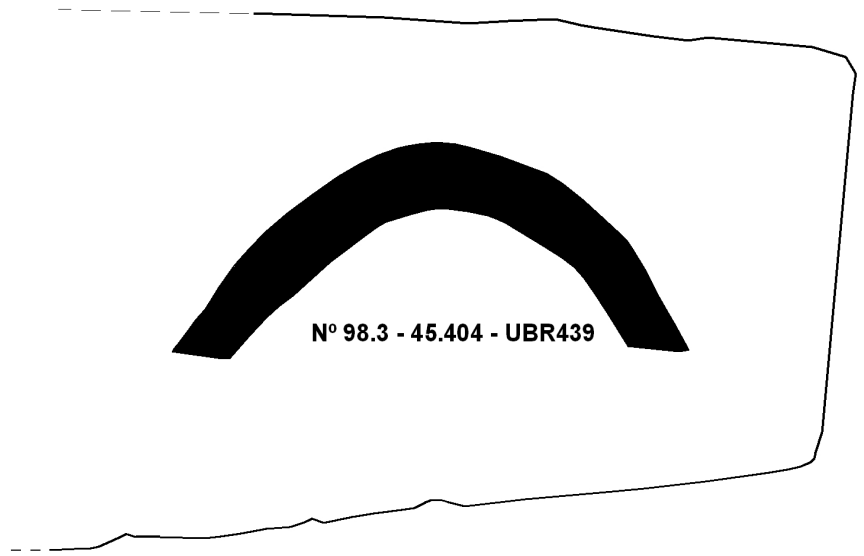

Nº 98.3 - 45.404 - UBR439

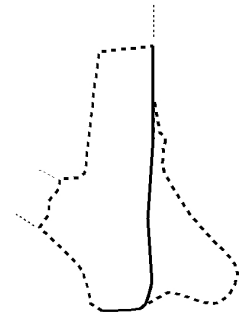
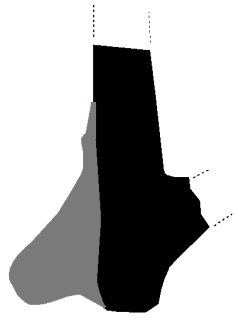

Nº 98.3 - 49.404 - 94B

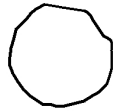
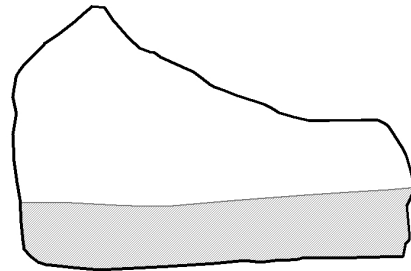
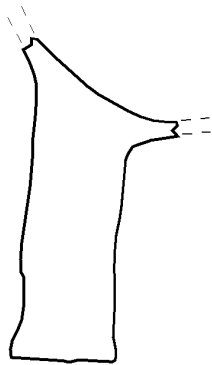

Nº 98.3 - 45.404 - UBR710G

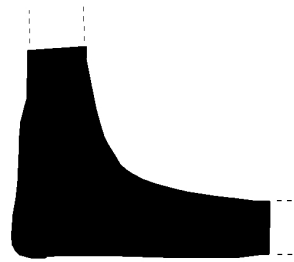

98.3 - 10.12/I - UBR624D

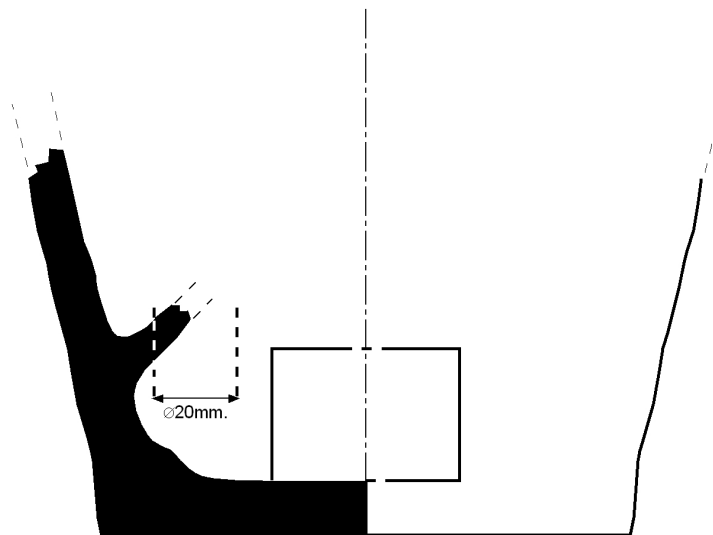

Nº 98.3 - 45.404 - UBR435A

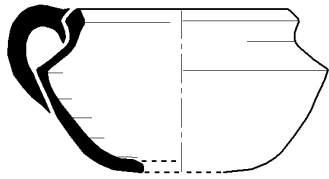

Nº 98.3 - 49.404 - UBR 490A

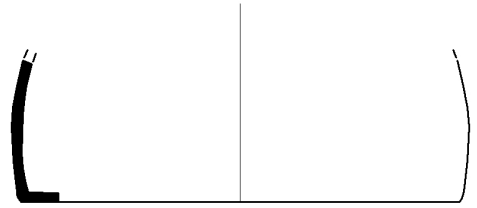

Nº 98.3 - 49.404 - UBR 772D

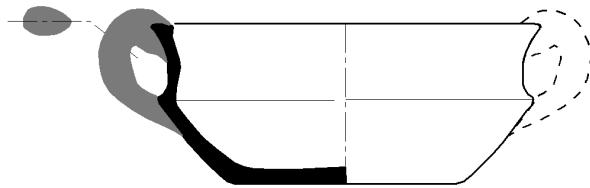

Nº 98.3 - 45.404 - UBR 468 B



Nº 98.3 - 49.404 - UBR297A

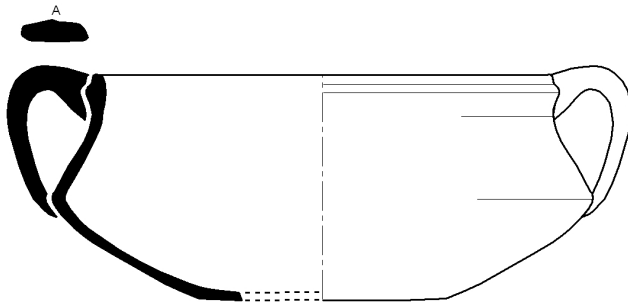

Nº 98.3 - 49.404- 61D

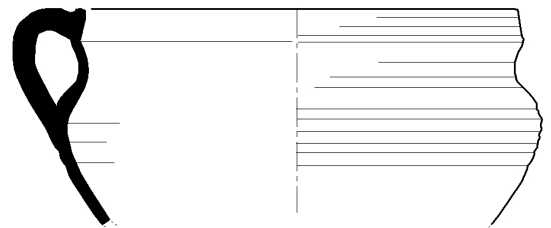

Nº 98.3 - 49.404 - 77A

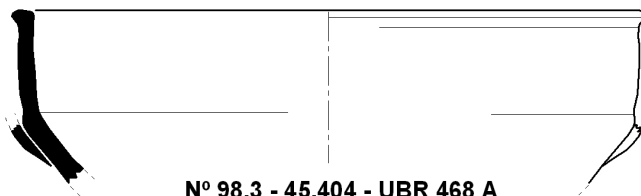

Nº 98.3 - 45.404 - UBR 468 A

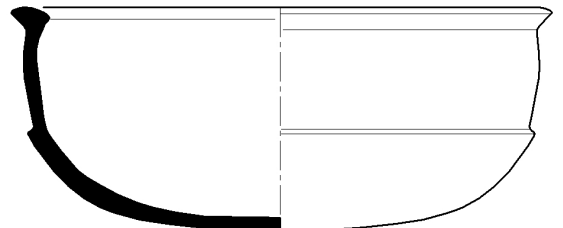

Nº 98.3 - 49.404 - 2D

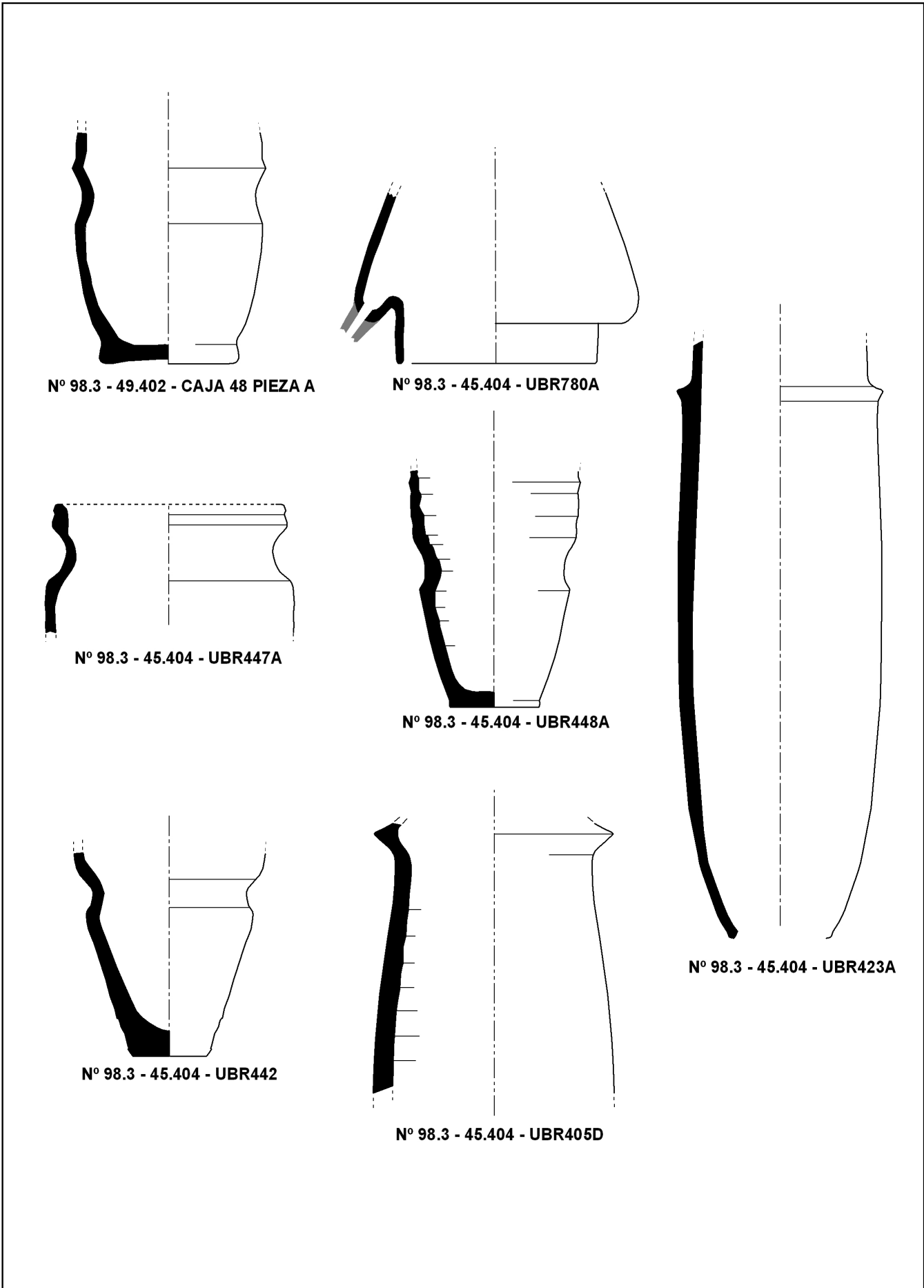



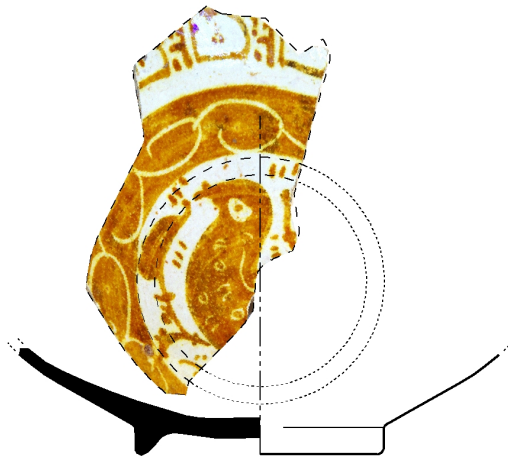

98.3 - 16/EF - 234406

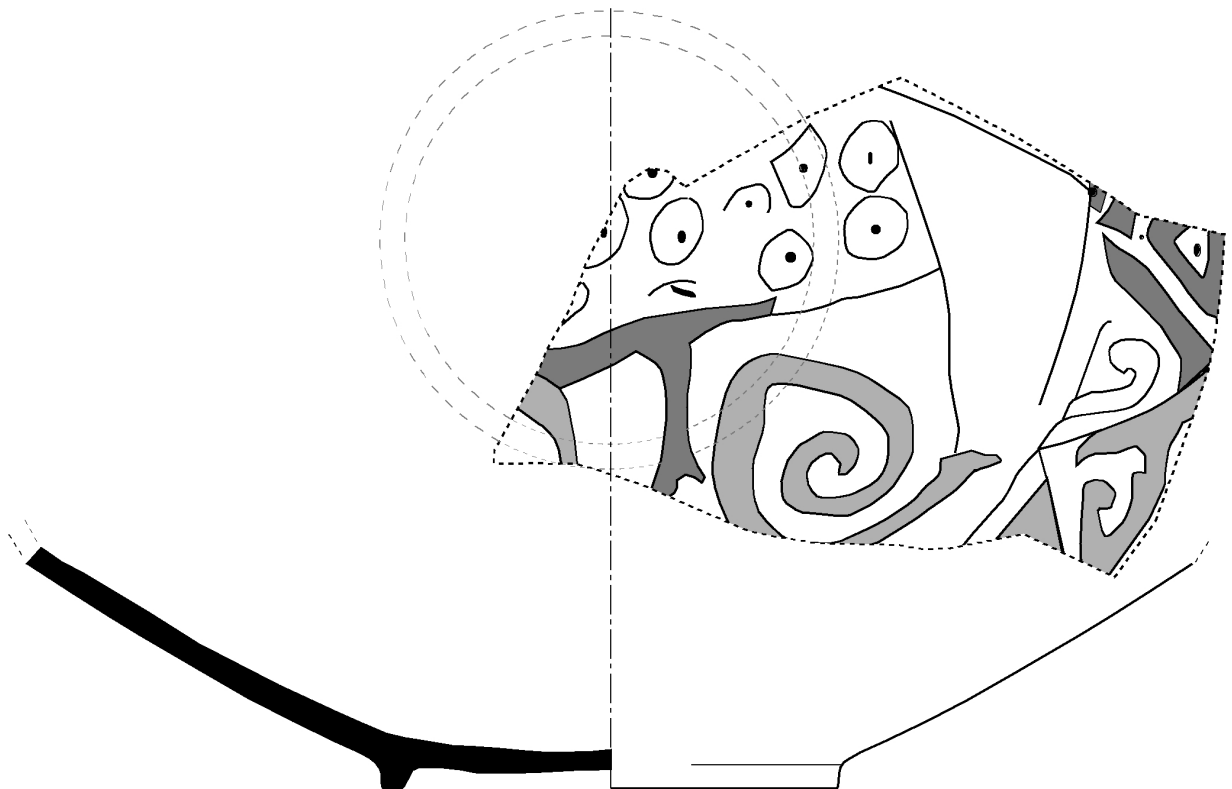

Nº 98.3 - 49.402 - 32A

ZOOMORFO ATAIFORES

ESCALA: 5 cm.



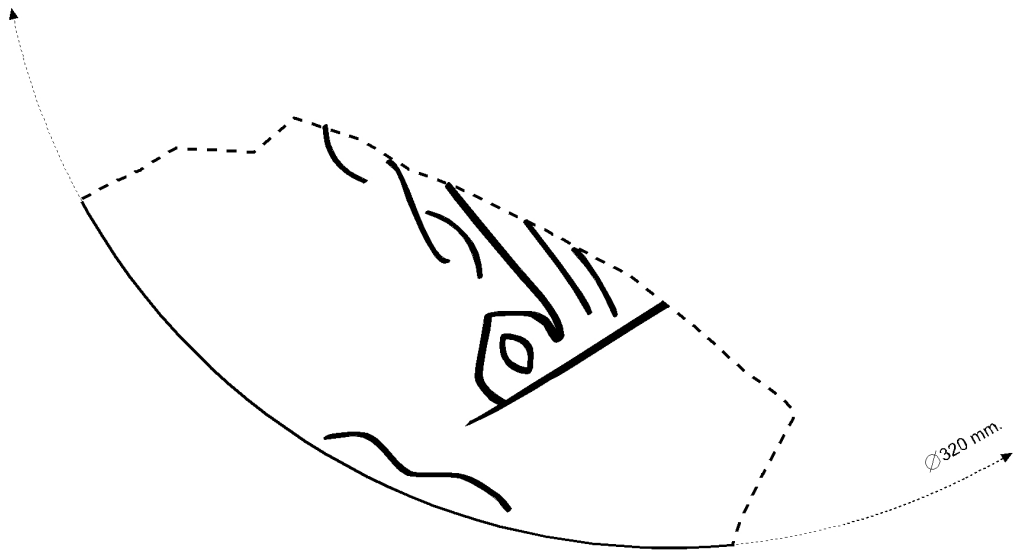

Nº 98.3 - 49.404 - UBR 211A



Nº 98.3 - 49.402 - 47A



Nº 98.3 - 49.402 - 43B

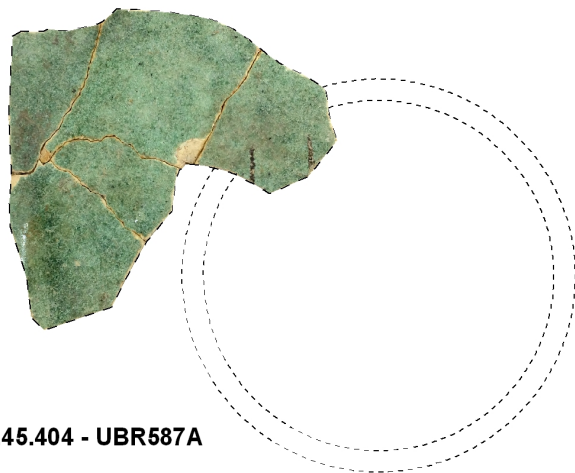

98.3 - U.45.404 - UBR587A



Nº 98.3 - 45.404 - UBR437



Nº 98.3 - 49.402 - 47A

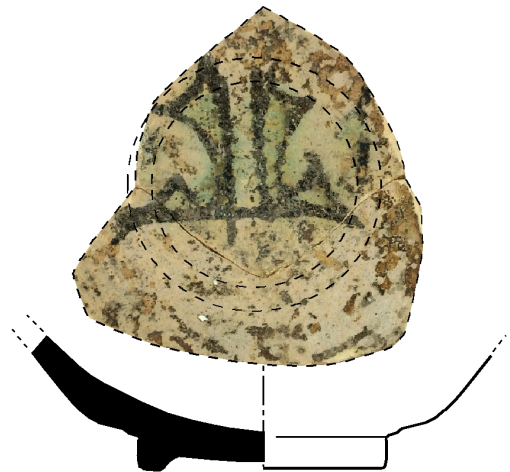

98.3 - POZO 191 - 109F



98.3 - 45.404 - UBR710B

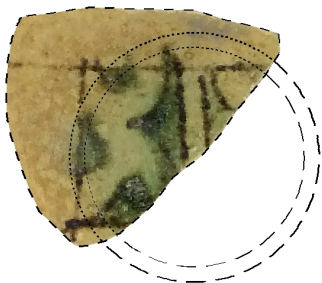

Nº 98.3 - 49.402 - 32B

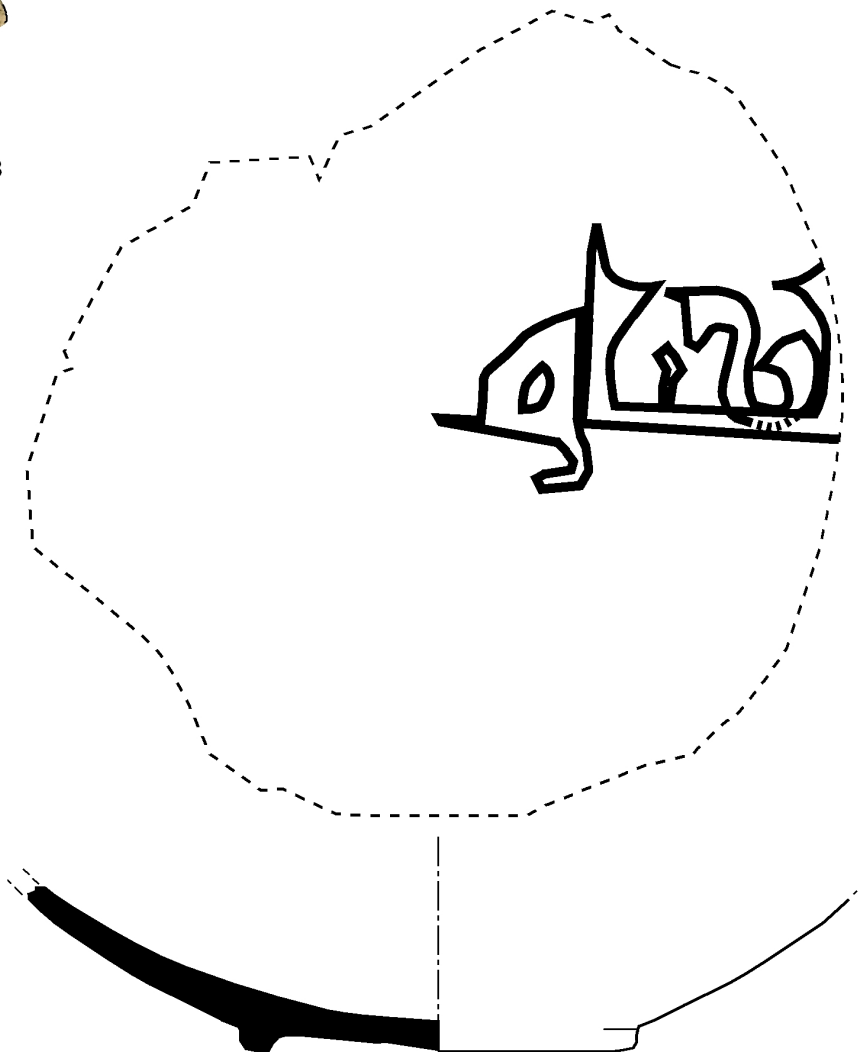

98.3 - P.136 - 108975



Nº 98.3 - POZO 245 - 326E



Nº 98.3 - 49.402 - 19A



Nº 98.3 - P.136- 105265

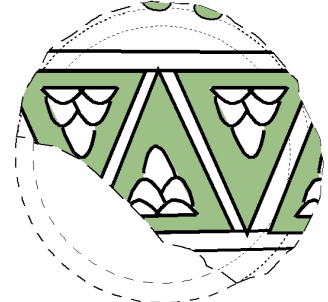

Nº 98.3 - 45.404 - UBR 465C

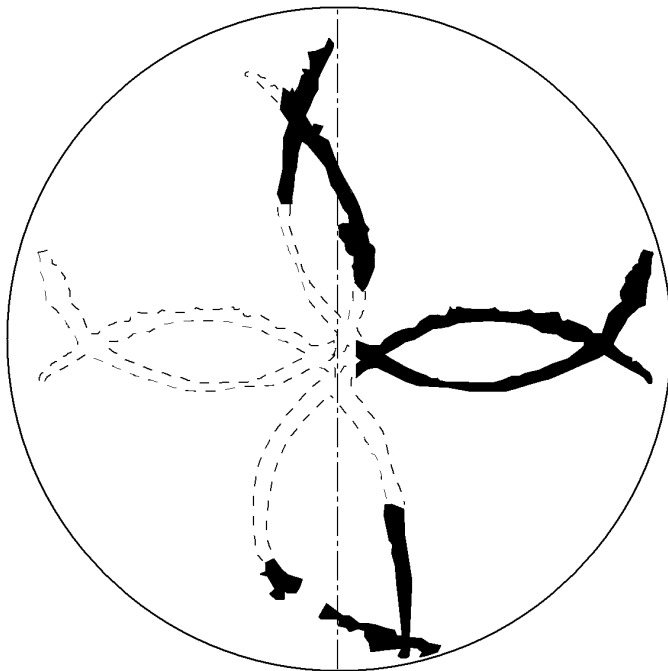

Nº 98.3 - p.123 -74004

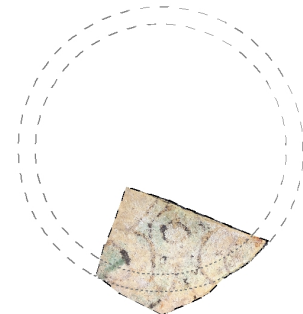

Nº 98.3 - 49.404 - UBR106A

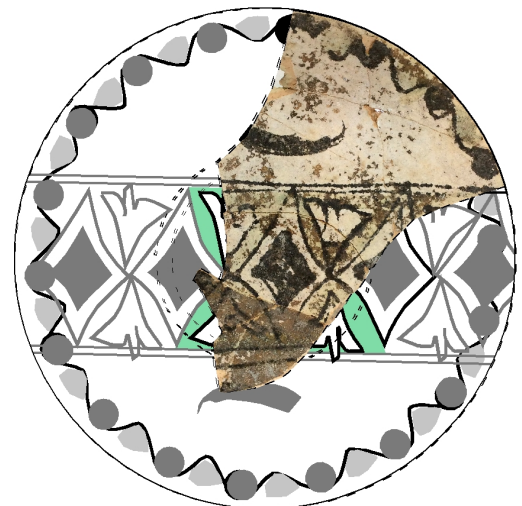
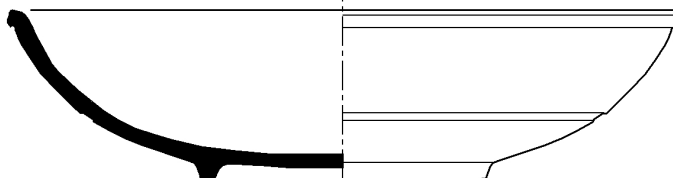

Nº 98.3 - POZO 227 - UBR33

VEGETAL ATAIFORES

ESCALA: 5 cm.



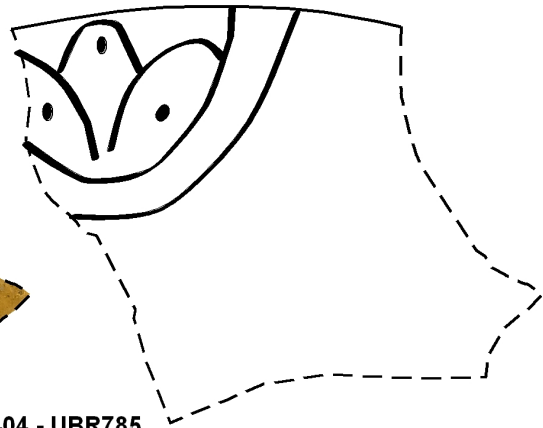

98.3 - U.45.404 - UBR785

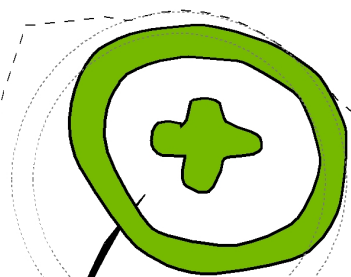
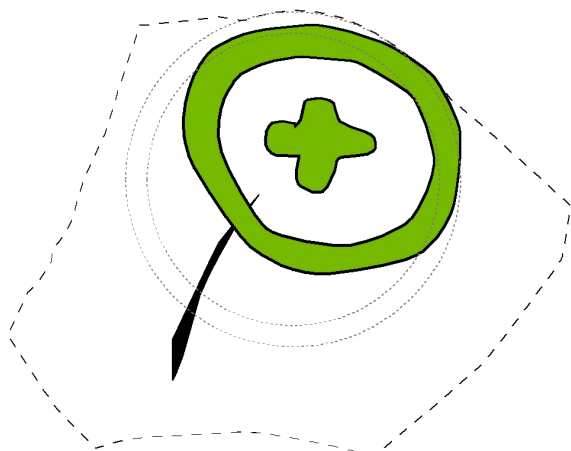

N° 98.3 - 45.404 - UBR475A

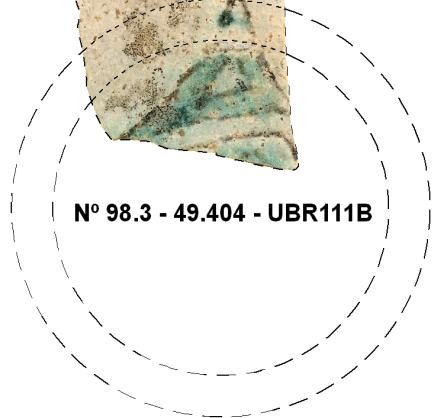
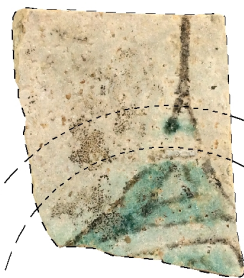

N° 98.3 - 49.404 - UBR111B

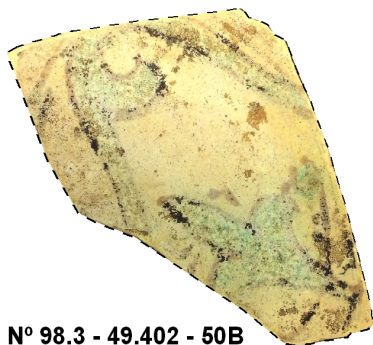

N° 98.3 - 49.402 - 50B



N° 98.3 - 45.404 - UBR624A



N° 98.3 - 49.402 - 46A

VEGETAL ATAIFORES

ESCALA: 5 cm.



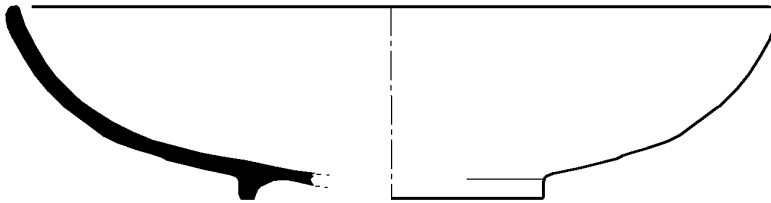

Nº 98.3 - P.132- 109390

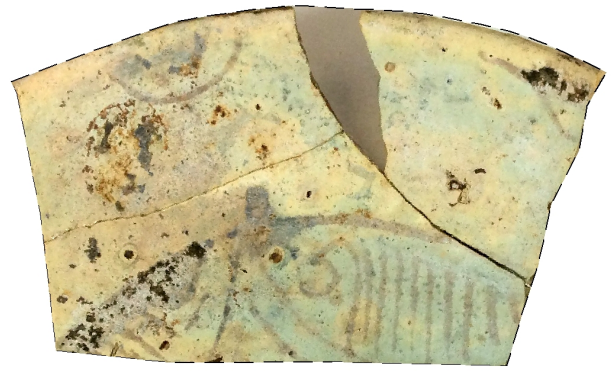

98.3 - 45.404 - UBR710B

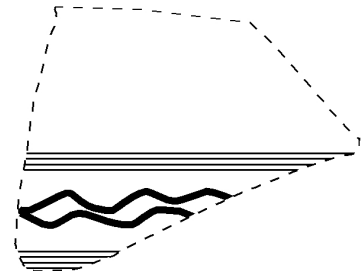

Nº 98.3 - P.143- 114297



Nº 98.3 - P.132- 109392



Nº 98.3 - 49.402 - 45C

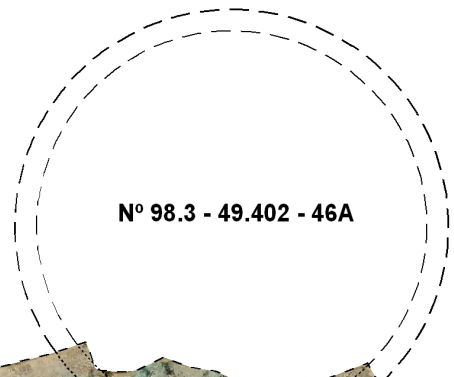

Nº 98.3 - 49.402 - 46A

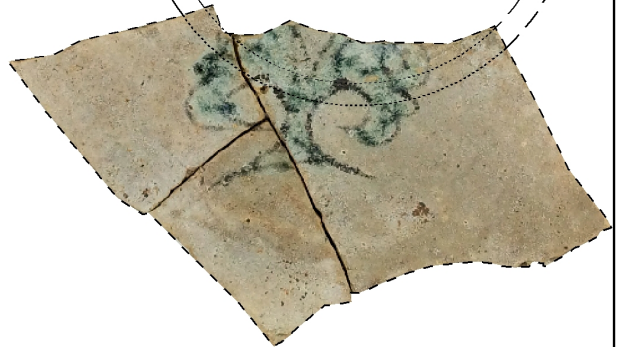

98.3 - U.45.404 - UBR671D

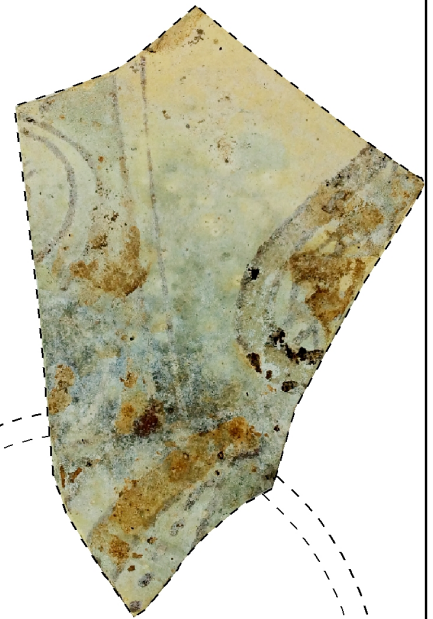

Nº 98.3 - 49.404 - 91A

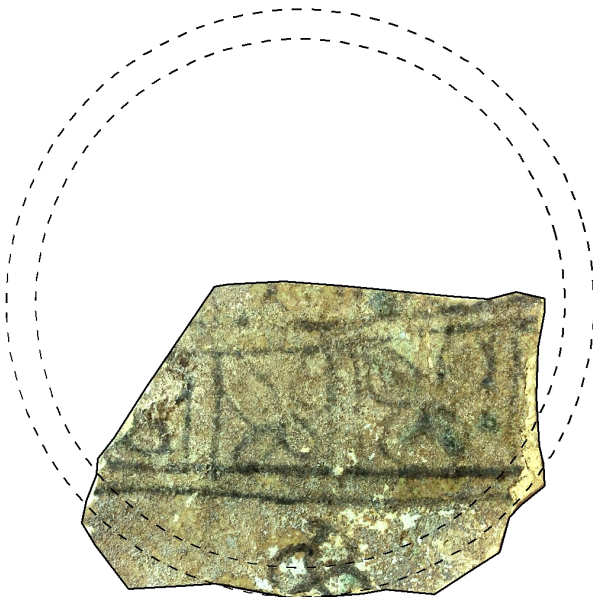

Nº 98.3 - P.50 - 56607

VEGETAL ATAIFORES

ESCALA: 5 cm.



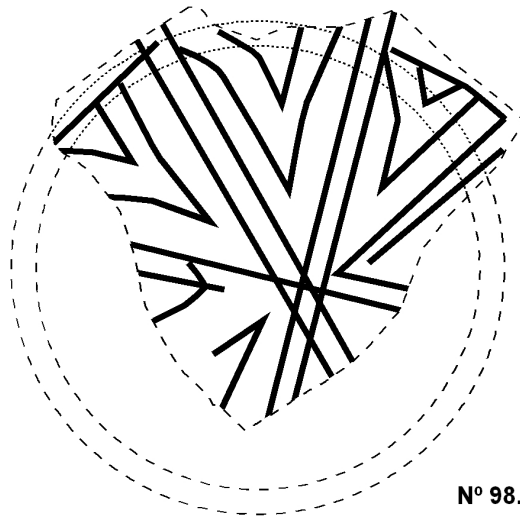

Nº 98.3 - 49.404 - UBR168A

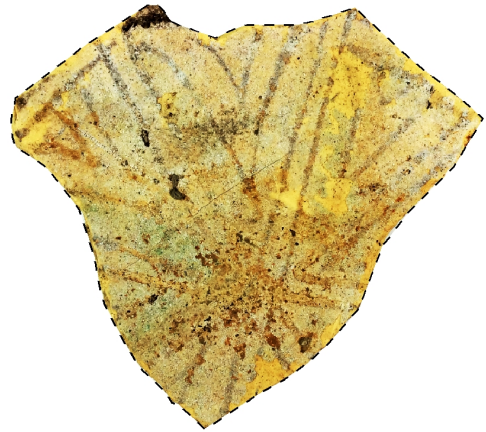

98.3 - U.45.404 - UBR704B

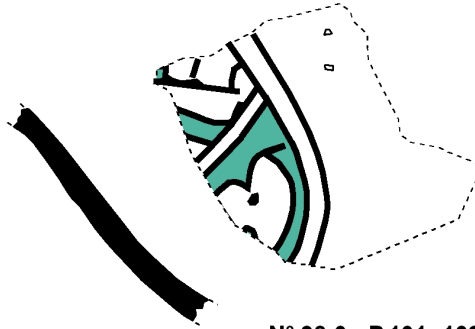

Nº 98.3 - P.131-109185

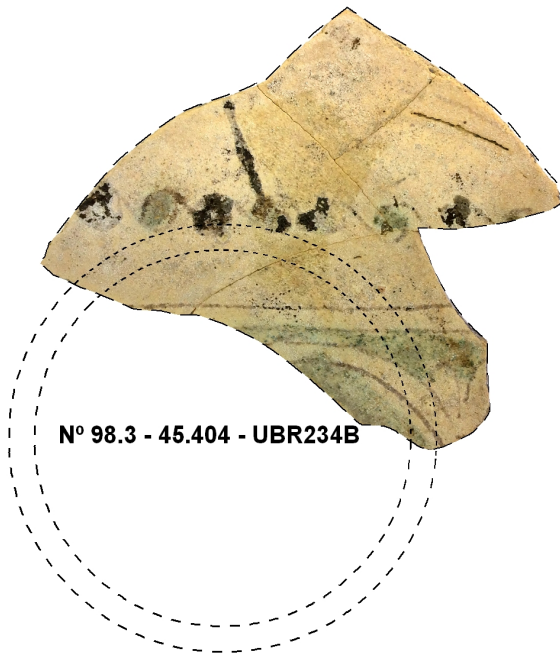

Nº 98.3 - 45.404 - UBR234B

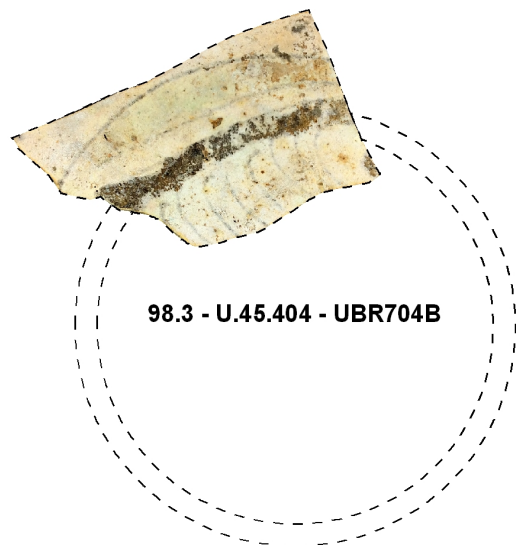

98.3 - U.45.404 - UBR704B



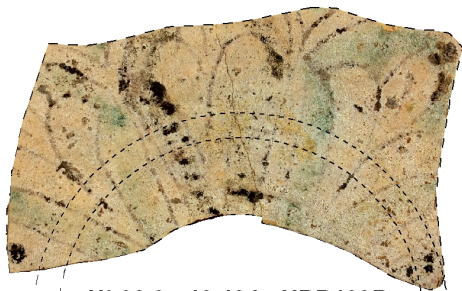

Nº 98.3 - 49.404 - UBR139B



98.3 - U.45.404 - UBR705B

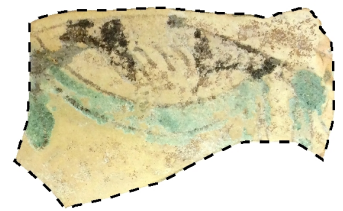

98.3 - U.45.404 - UBR587E



Nº 98.3 - 45.404 - UBR471B



Nº 98.3 - 45.404 - UBR471B



Nº 98.3 - 49.404 - UBR 211B



Nº 98.3 - 49.402 - 26A

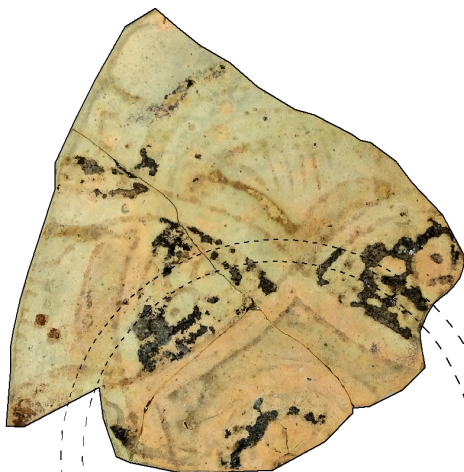

98.3 - 45.404 - UBR527D



Nº 98.3 - 49.402 - 45B

VEGETAL ATAIFORES

ESCALA: 5 cm.





Nº 98.3 - 38.42/AL - 70055

98.3 - 49.404 - 62B

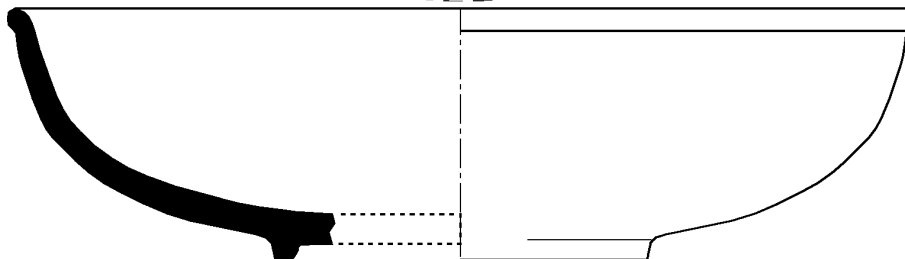
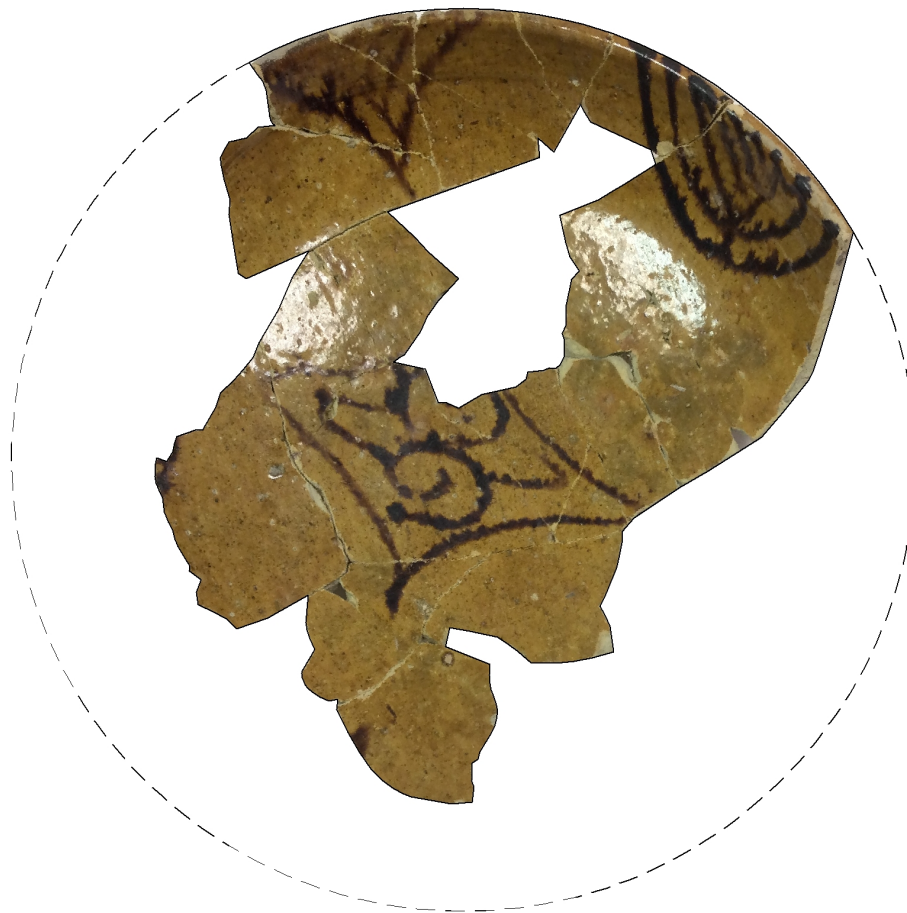

Nº 98.3 - 49.404 - UBR124A

VEGETAL ATAIFORES

ESCALA: 5 cm.





Nº 98.3 - 26.32/AM.AÑ - 100700

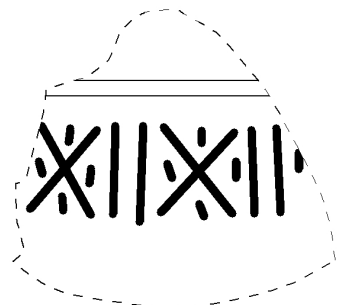

Nº 98.3 - SINUBR - 1B\_A

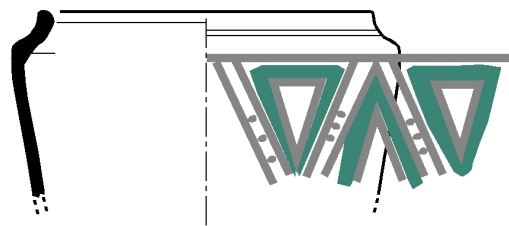

Nº 98.3 - POZO 181 - UBR270A

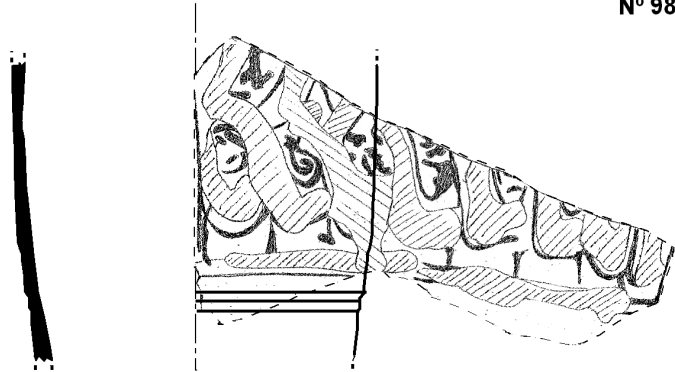

Nº 98.3 - P.136 - 108969

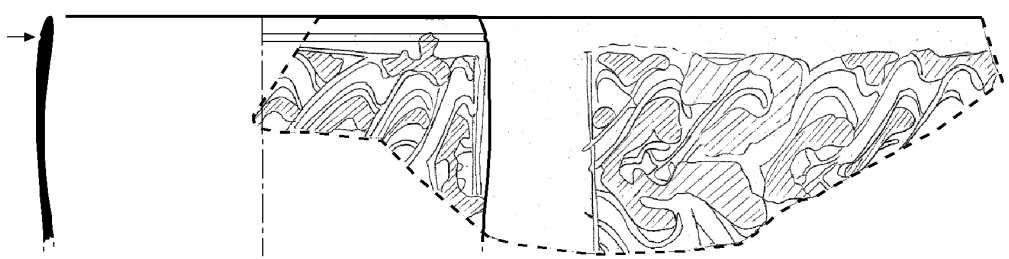

Nº 98.3 - P.151- 119086

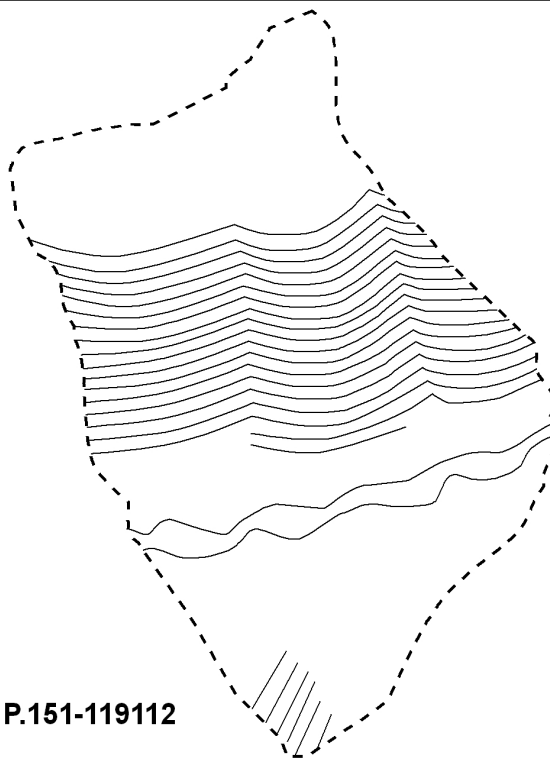

Nº 98.3 - P.151-119112



Nº 98.3 - 49.401 - 220980

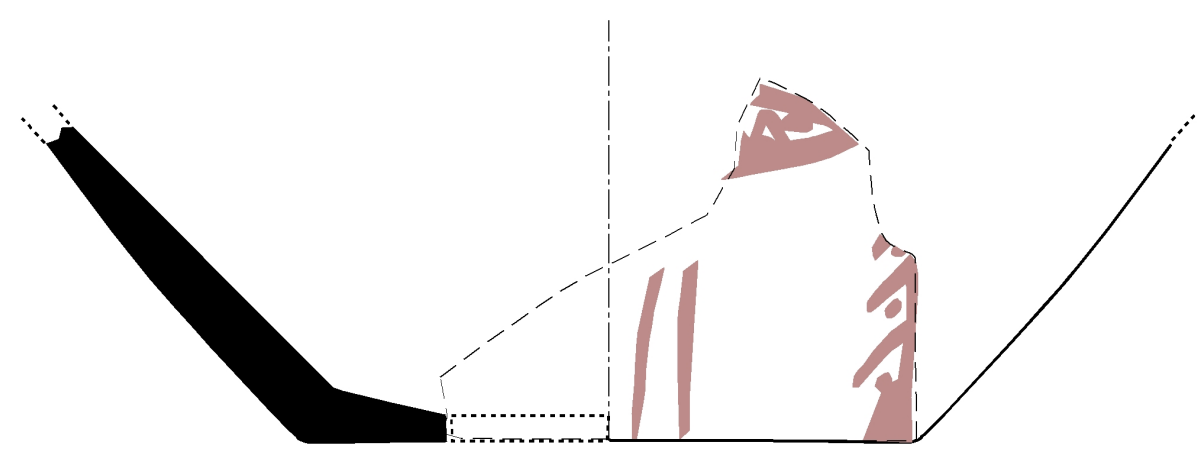

Nº 98.3 - 49.404 - 70A

GEOMETRICO

ESCALA: 5 cm.



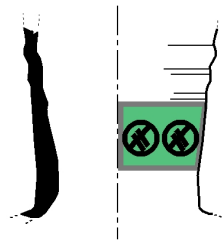

Nº 98.3 - P.184 - 180187

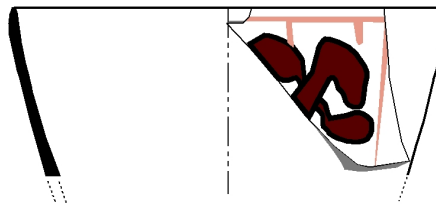

Nº 98.3 - P.77 - 57413

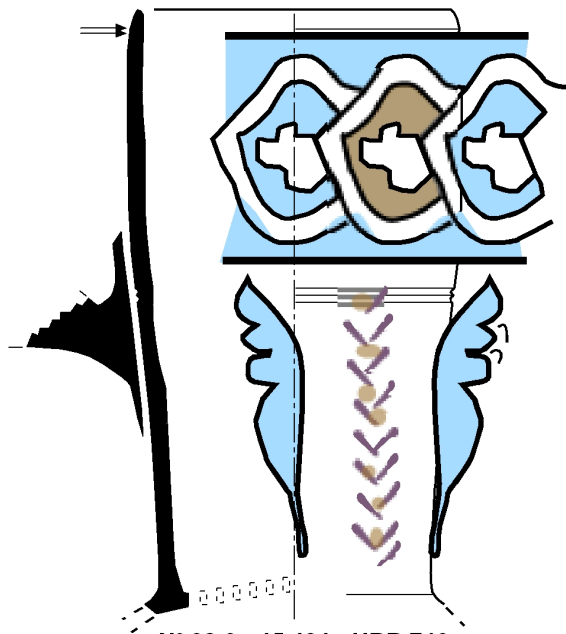
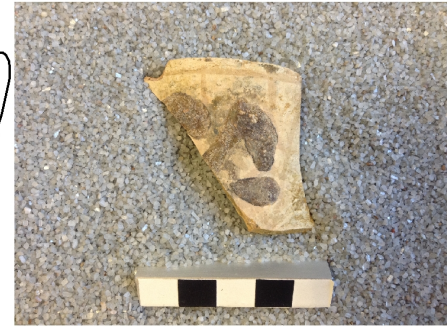

Nº 98.3 - 45.404 - UBR 713

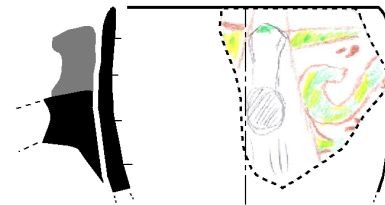

Nº 98.3 - 49.402 - 21A

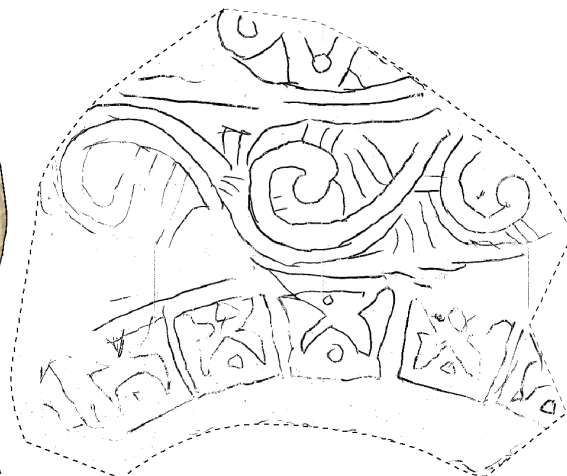

Nº 98.3 - 49.404 - UBR60A

VEGETAL JARRAS

ESCALA: 5 cm.



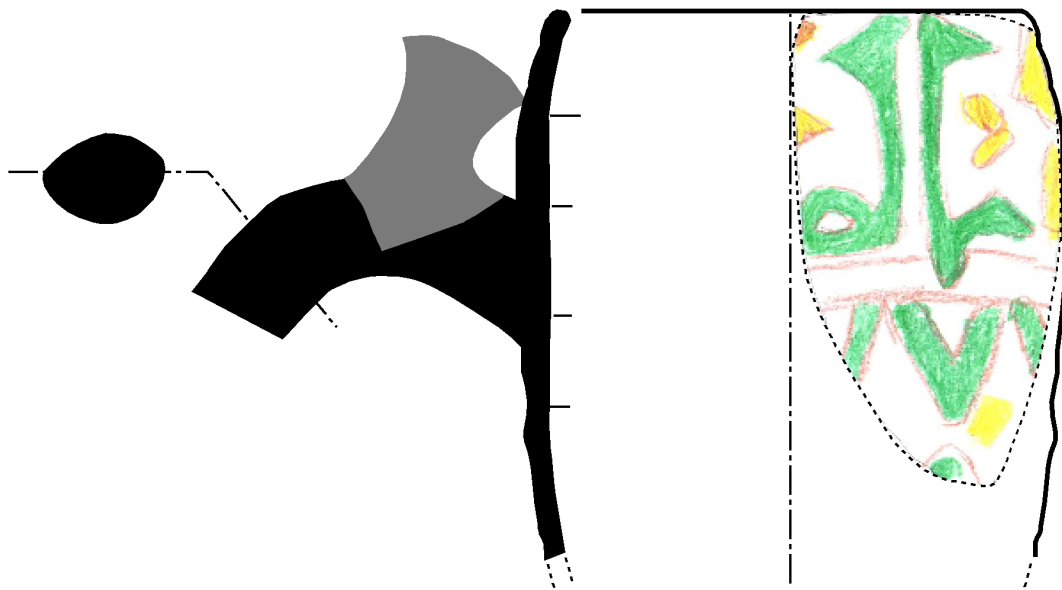

Nº 98.3 - 2.4/J.L. - 161220

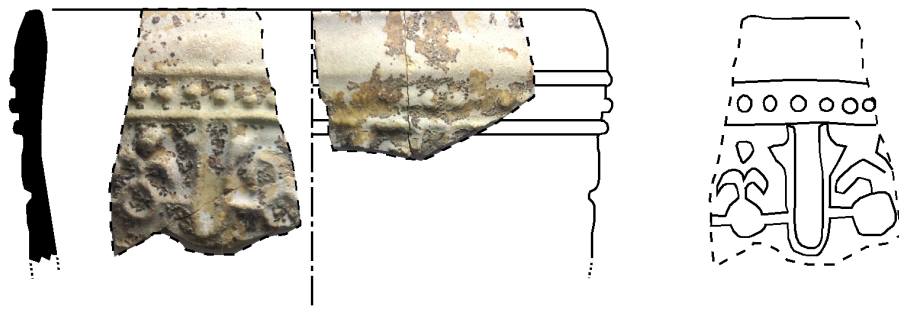

98.3 - P.136 - 108970

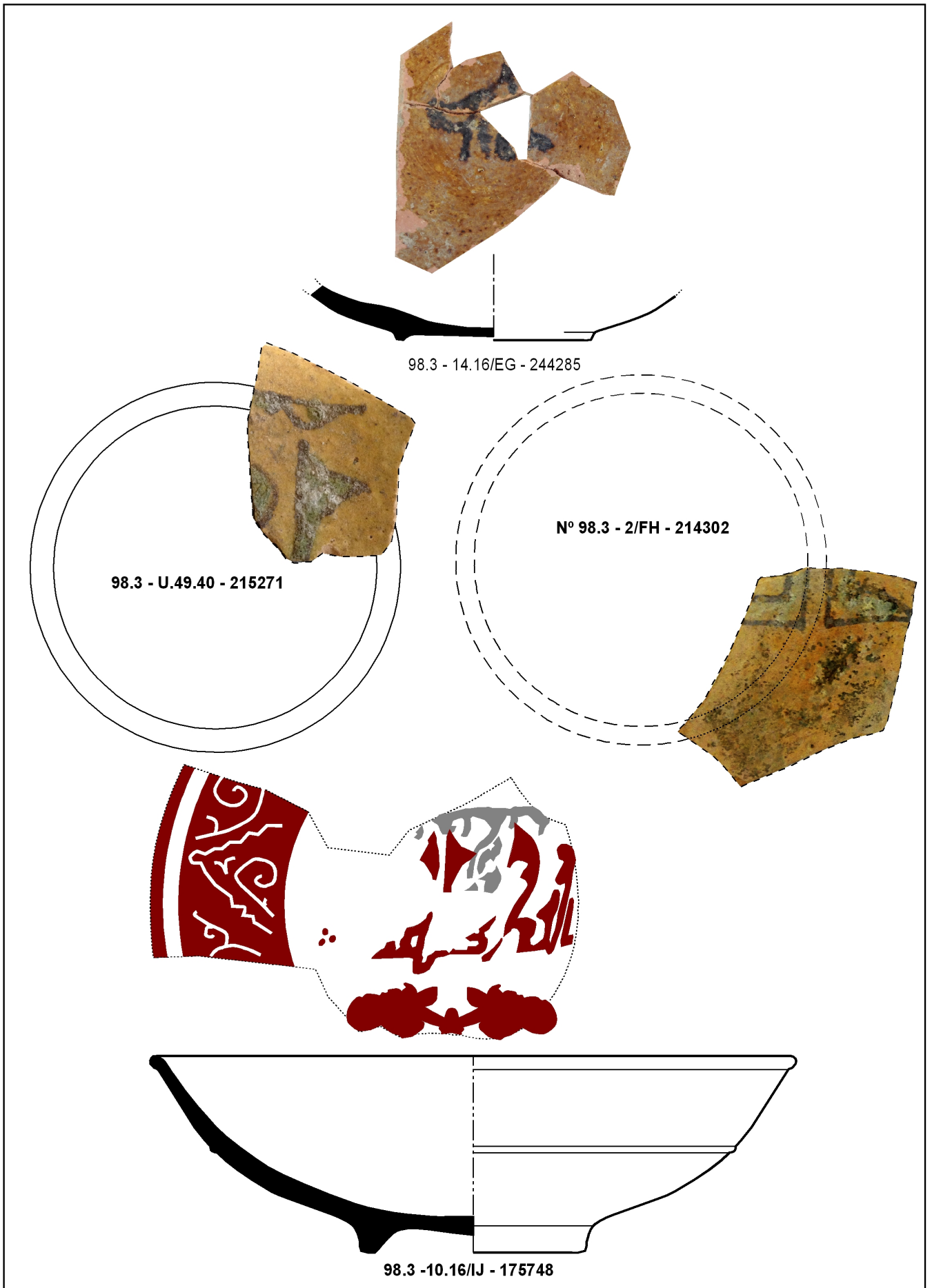

EPIGRAFICO

ESCALA: 5 cm.



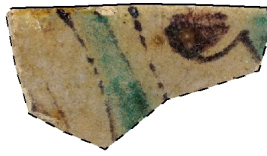

N° 98.3 - P.155- 120066



N° 98.3 - P.155- 120065

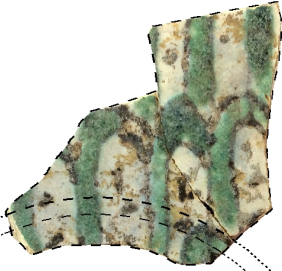

N° 98.3 - 49.402 - 52A

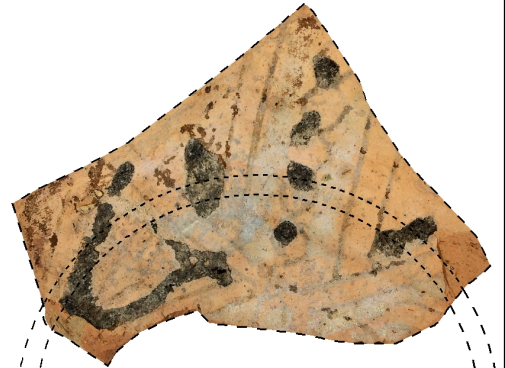

98.3 - 45.404 - UBR527E

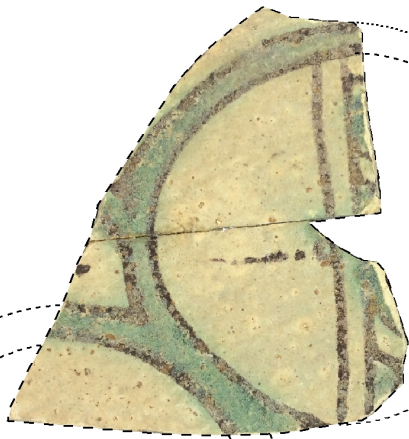

N° 98.3 - 49.402 - 28B

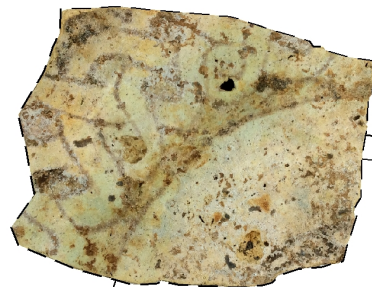

N° 98.3 - 49.404 - 82A





Nº 98.3 - 49.404 - 78A



Nº 98.3 - 49.402 - 41A



Nº 98.3 - 49.402 - 41A

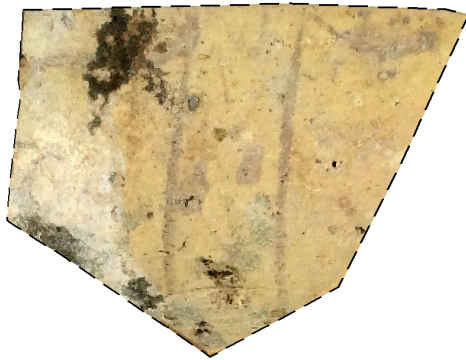

98.3 - 45.404 - UBR710B

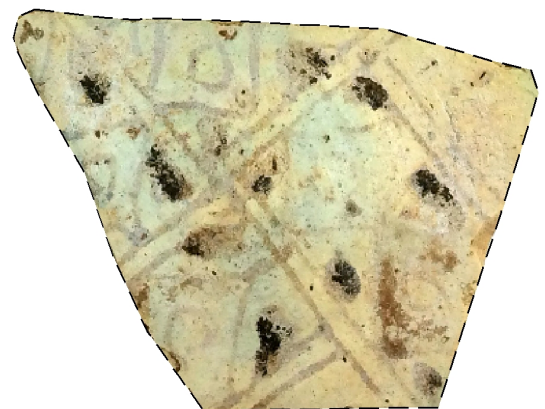

98.3 - 45.404 - UBR710B

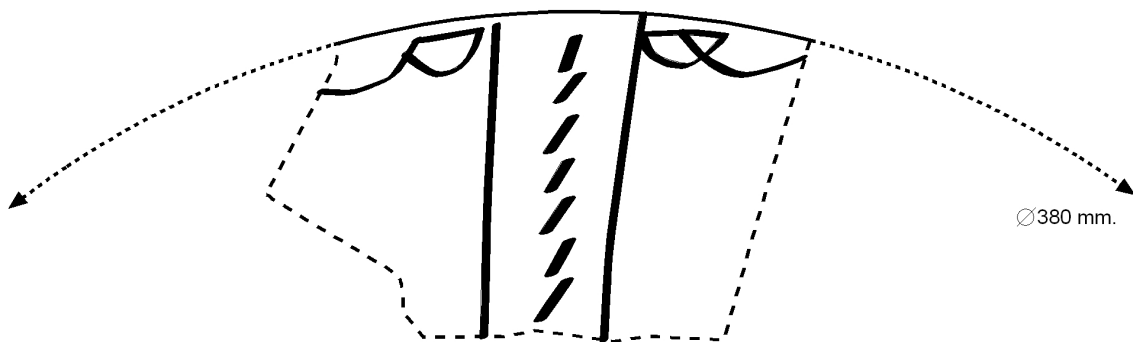

Nº 98.3 - 49.404 - UBR 211C

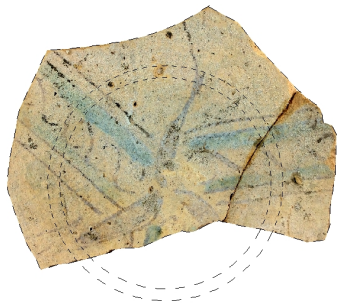

98.3 - U.45.404 - UBR705C

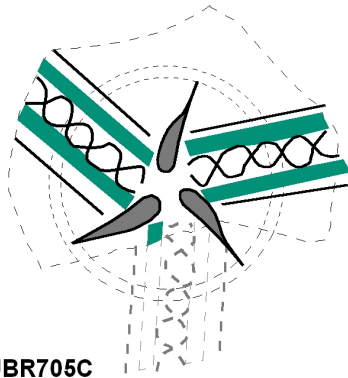

Nº 98.3 - P.191 - 197326

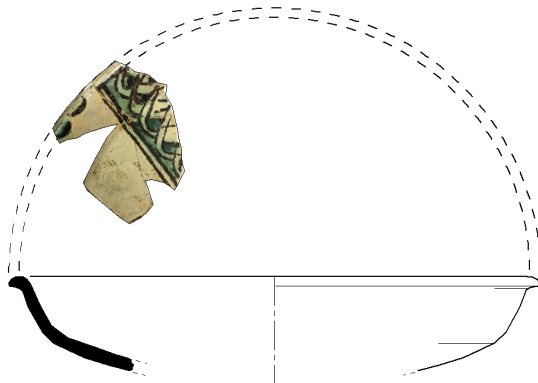

Nº 98.3 - 45.404 - UBR471C

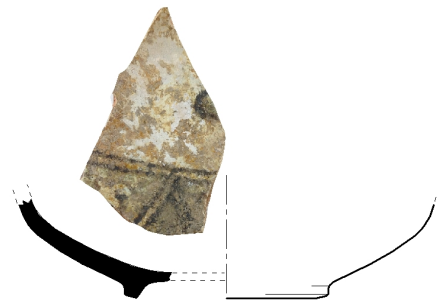

Nº 98.3 - P.131- 91795



98.3 - U.45.404 - UBR798A

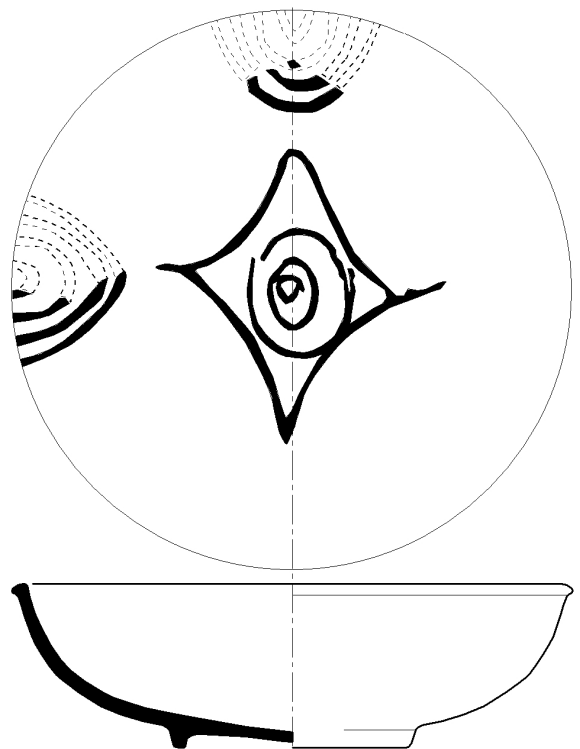

Nº 98.3 - 49.404 - 78B

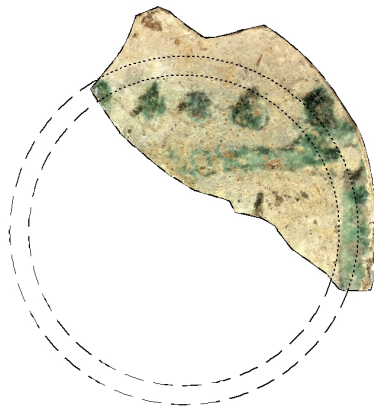

Nº 98.3 - 45.404 - UBR467A

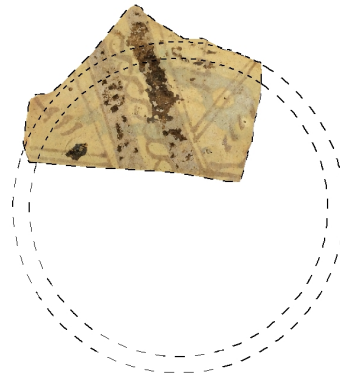

Nº 98.3 - 45.404 - UBR624E

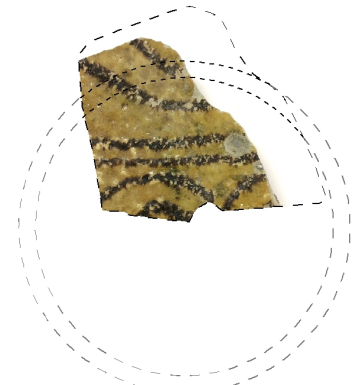

98.3 - U.49.404 - UBR233B

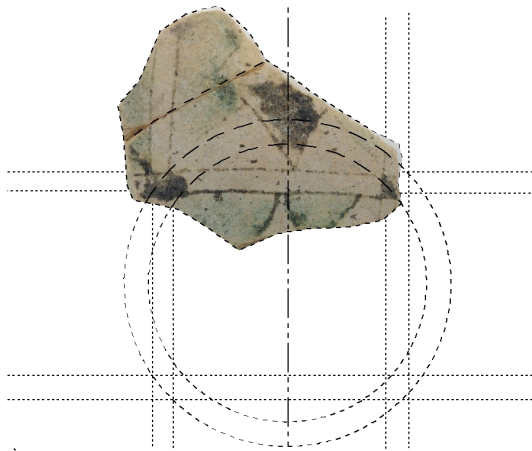

Nº 98.3 - POZO 14 - 7424

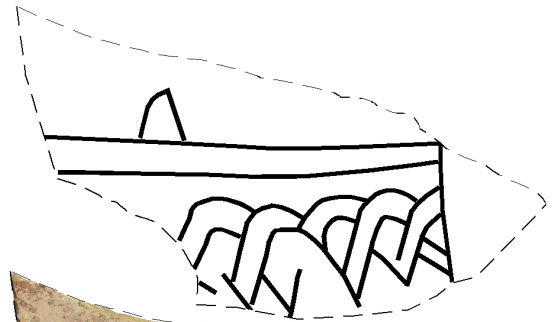

Nº 98.3 - 49.402 - 19B

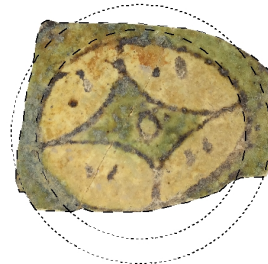

Nº 98.3 - 49.402 - 5C

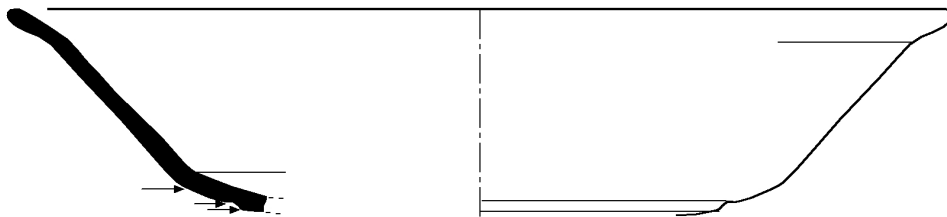
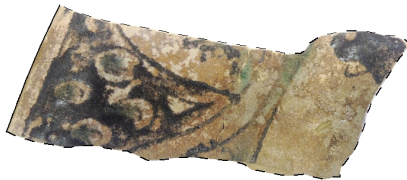

Nº 98.3 - P.132- 109391

GEOMETRICO ATAIFORES

ESCALA: 5 cm.





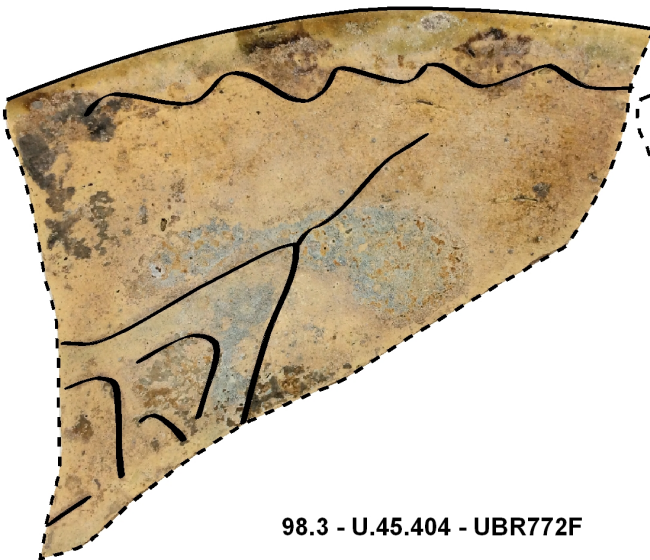

98.3 - U.45.404 - UBR772F

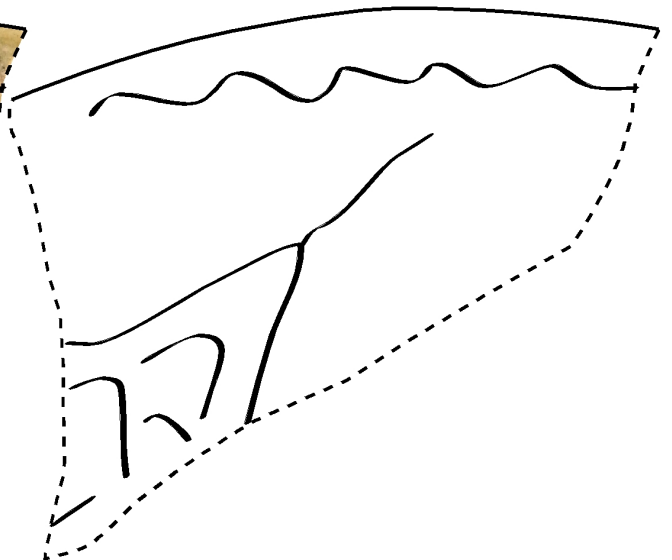

98.3 - U.45.404 - UBR882A

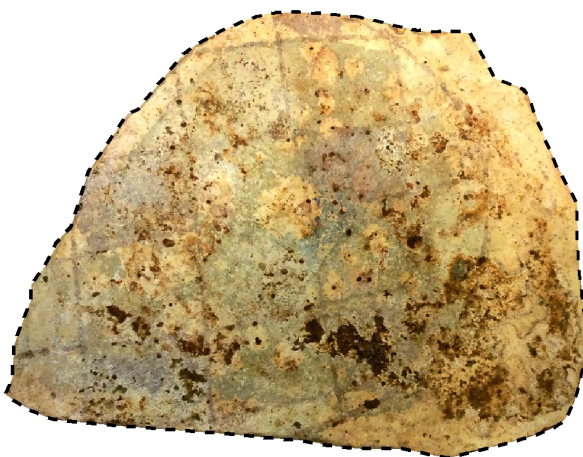
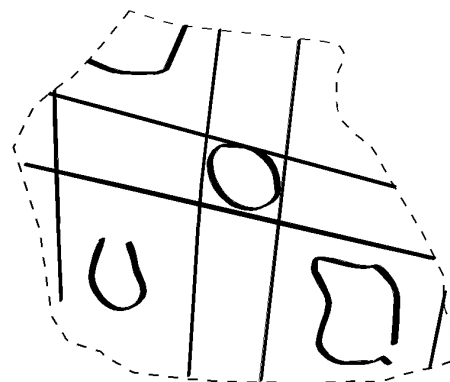

98.3 - U.45.404 - UBR882A

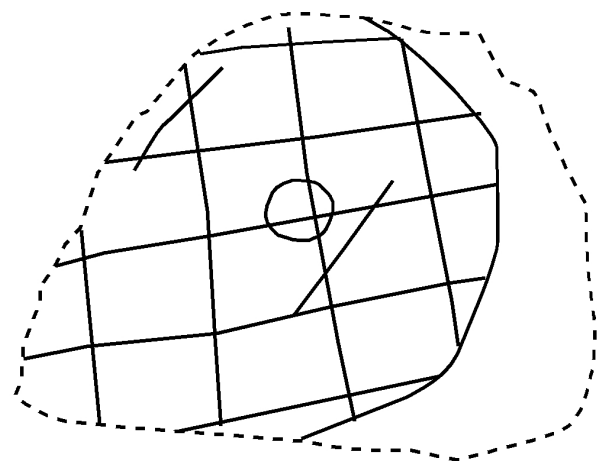

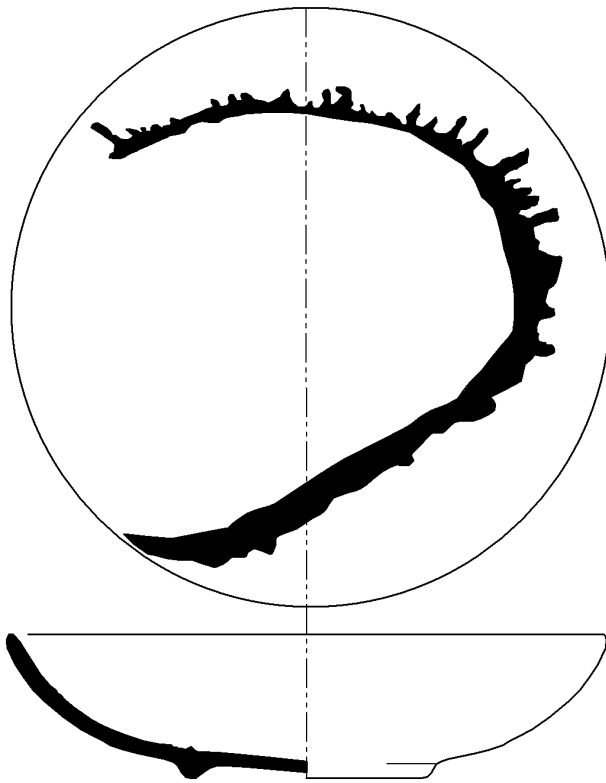

Nº 98.3 - P.151-119088



Nº 98.3 - 45.404 - UBR709F

DECORACIÓN LIBRE

ESCALA: 5 cm.





Nº 98.3 - 49.401 - 220986



Nº 98.3 - 45.404 - UBR471C

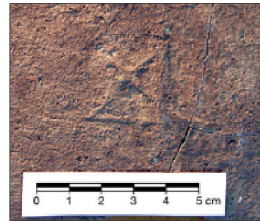

98.3 - P.42 - 37613

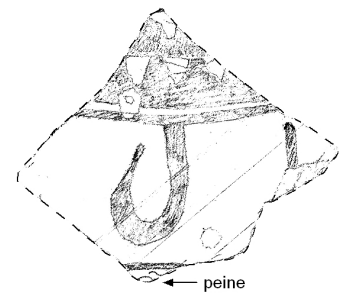
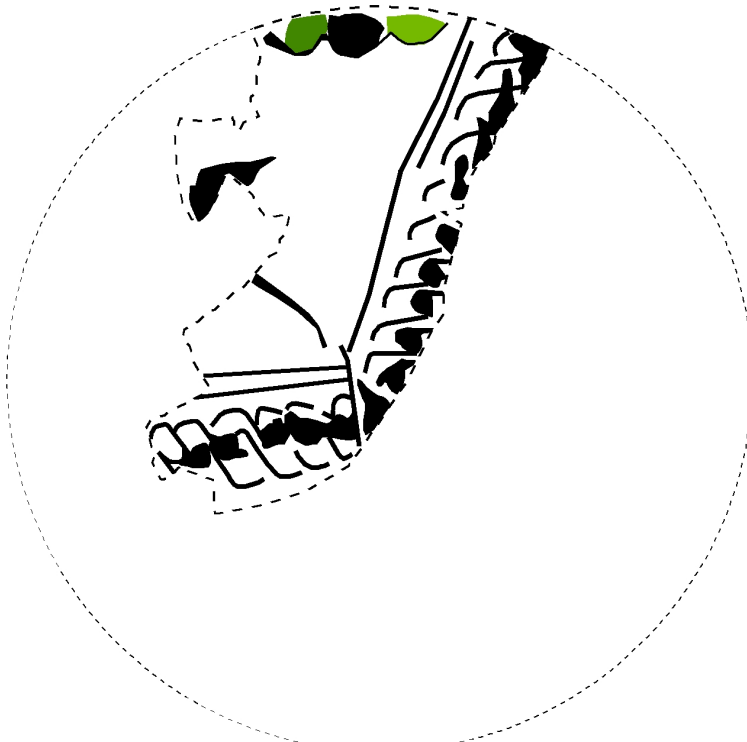
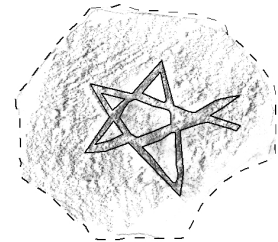

Nº 98.3 - P.184 - 180051

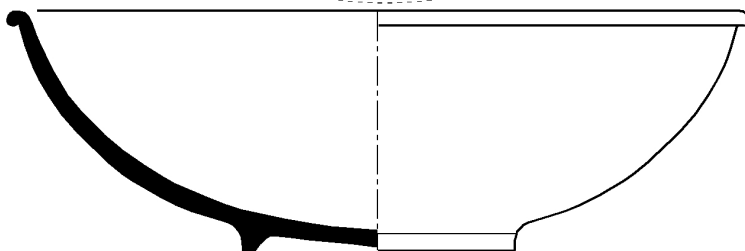

Nº 98.3 - POZO 245 - 326A

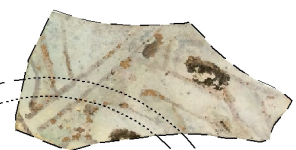

Nº 98.3 - 49.402 - 46A