

A: ángulo de desmoldeo 3°

SI NO SE INDICA LO CONTRARIO, LAS COTAS SE EXPRESAN EN MM				ACABADO: Fundición		REVISIÓN	
DIBUJ. Voltejo Royo, Javier				FIRMA		FECHA	
VERIF.				TITULO:		Pieza fundición	
APROB.				MATERIAL:		N.º DE DIBUJO	
FABR.				Aleacion Wood		1	
CALID.				PESO:		A3	
						HOJA 1 DE 1	

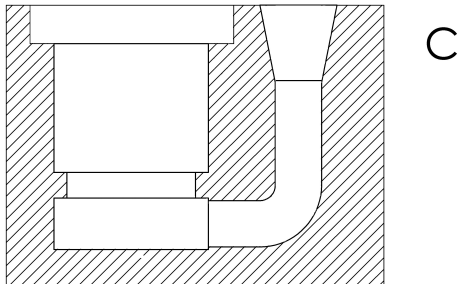

				NAME	DATE	<b>Boceto molde</b>
				DRAWN		
				CHECKED		
				ENG APPR.		
				MFG APPR.		
				Q.A.		
				COMMENTS:		
NEXT ASSY	USED ON	FINISH	--			SIZE <b>A</b>
APPLICATION		DO NOT SCALE DRAWING				DWG. NO.
						REV.
						SCALE:1:2
						WEIGHT:
						SHEET 1 OF 1

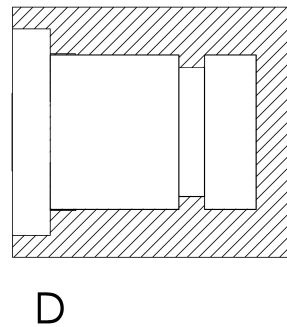
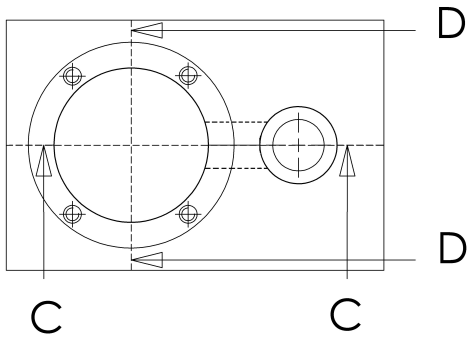
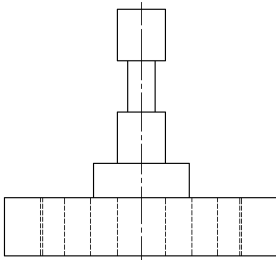
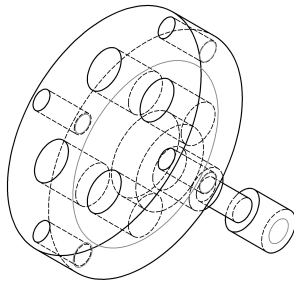
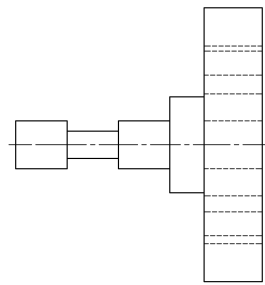
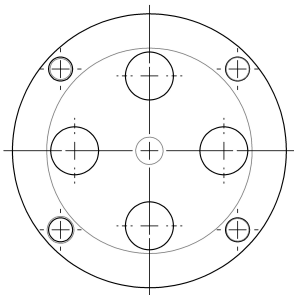

SI NO SE INDICA LO CONTRARIO: LAS COTAS SE EXPRESAN EN MM				ACABADO:		REBARBAR Y ROMPER ARISTAS VIVAS		NO CAMBIE LA ESCALA		REVISION	
LINEAL:											
ANGULAR:											
DIBUJ.		NOMBRE		FIRMA		FECHA		TRUJ.CI.		Boceto Macho	
VERIF.											
APROB.											
FABR.											
CALID.											
						MATERIAL:		N.º DE DIBUJO		A3	
						PESO:		ESCALA:1:1		HOJA 1 DE 1	