

# Impact Assessment of Different Battery Energy Storage Technologies in Distribution Grids with High Penetration of Renewable Energies

S. P. Surve<sup>1,2</sup>, R. Rocca<sup>2</sup>, E.J. Hengeveld<sup>1</sup>, D. Martínez<sup>2</sup>, M. P. Comech<sup>3</sup> and D. M. Rivas<sup>2</sup>

<sup>1</sup> Hanze University of Applied Sciences  
 9747 AS Groningen (Netherlands)

e-mail: [s.p.surve@st.hanze.nl](mailto:s.p.surve@st.hanze.nl), [e.j.hengeveld@pl.hanze.nl](mailto:e.j.hengeveld@pl.hanze.nl)

<sup>2</sup> Electrical Systems Department

CIRCE Foundation (Research Centre for Energy Resources and Consumption), 50018 Zaragoza, Spain

e-mail: [rrocca@fcirce.es](mailto:rrocca@fcirce.es), [dmartinez@fcirce.es](mailto:dmartinez@fcirce.es), [dmrivas@fcirce.es](mailto:dmrivas@fcirce.es)

<sup>3</sup> CIRCE Research Institute

University of Zaragoza, 50018 Zaragoza, Spain

e-mail: [mcomech@unizar.es](mailto:mcomech@unizar.es)

## Abstract

The need for increasing further the penetration of Renewable Energy Sources (RESs) is demanding a change in the way distribution grids are managed. In particular, the RESs intermittent and stochastic nature is finding in Battery Energy Storage (BES) systems its most immediate countermeasure. This work presents a reality-based assessment and comparison of the impact of three different BES technologies on distribution grids with high RES penetration, namely Li-ion, Zn-Air and Redox Flow. To this end, a benchmark distribution grid with real prosumers' generation and load profiles is considered, with the RES penetration purposely scaled up in such a way as to violate the grid operational limits. Then, further to the BES(s) placement on the most affected grid location(s), the impact of the three BES types is assessed considering two Use Cases: 1) Voltage & Congestion Management and 2) Peak Shaving & Energy shifting. Assessment is conducted by evaluating a set of technical Key Performance Indicators (KPIs), together with a simplified economic analysis.

**Key words.** Battery Energy Storage, Renewable Energy, Lithium-ion, Zinc-Air, Redox Flow.

## 1. Introduction

The increasing penetration of Renewable Energy Sources (RESs) is re-shaping our paradigm of distribution grid management. In particular, issues related to the unbalance between energy generation and demand at prosumers level are finding in electric energy storage systems their most immediate solution, [1], [2].

Among the various storage technologies, Lithium-ion Battery Energy Storages (BESs) dominates the market nowadays, mainly thanks to their high energy density. On the other hand, these batteries are not yet a cost-effective option for large-scale integration of RES and pose a safety and environmental risk due to the flammable carbonates used in their manufacturing, as well as the toxic materials contained in the chemical composition, [3]. Consequently, researchers have been studying and recommending various alternative battery types over the last few years. Among

them, Zinc-air and Redox Flow Batteries are attracting considerable attention [4]–[6].

A careful review of the existing literature on BESs pointed out that most of the research efforts are currently being directed towards the modelling and characterisation of the different BES types, mostly in laboratory environments [5], [7]. Consequently, a relatively unexplored aspect related to the different BES types is the assessment, quantification and comparison of their impact in real distribution grids with a high RES penetration.

BESs may be used by different stakeholders in a wide range of applications (Use Cases (UCs)), as it is shown in Figure 1. For what is concerned with the installation in distribution grids with high RES content, the most important UCs may be identified as follows: 1) managing network congestions & overvoltages; 2) reducing utility bills and/or generating revenues for the prosumer by means of Demand Response, i.e. Peak Shaving and/or Energy Shifting.

Following from the above, the technical/scientific contribution this work wishes to provide is the development of a fair and meaningful assessment and comparison of the impact of three different BES types in a real distribution grid with high RES penetration:

- Lithium-ion (Li-ion).
- Zinc-air (Zn-air);
- Redox Flow Batteries (RFB).

The comparison is based on the definition and evaluation of a set of Key Performance Indicators (KPIs) relevant to

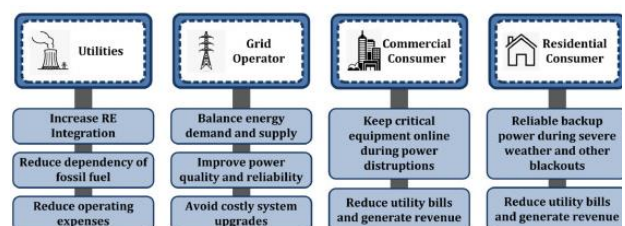

Figure 1: Different Use Cases of BESs for different stakeholders, adapted from [1].

the aforementioned two UCs, [8], before and after the BESs placement, together with a preliminary economic analysis.

## 2. Impact Assessment Methodology

Figure 2 provides a detailed description of the methodology followed for assessing and comparing the impact of the three BESs types discussed above. Simulations have been carried out with PowerFactory-DIGSILENT, [9]. In particular, quasi-dynamic simulations have been used considering a one-year time horizon.

### A. Network and RES penetration scenarios

This study has considered a publicly available standard *SimBench1* benchmark network, [10], with existing RES and load profiles. The network consists of an HV-MV substation connected to an external grid and a large MV and LV distribution network. The network topology is shown in Appendix 1.

For the purposes of this work, considering the entire grid would require unnecessarily high computation and time resources. Hence, only a sufficiently small portion of the network is chosen to be manipulated, which is named “Almagrid” feeder.

Further to the feeder selection, reminding that real generation data have been imported, RES penetration is purposely scaled up in such a way as to violate the grid operational limits. Voltage violations in the Almagrid feeder start to appear at RES penetration of 125% of the initially installed capacity. Hence, this scenario represents the initial base case for evaluating the BES impact.

### B. Use Cases

Once the grid to be studied has been identified and the penetration of RES has been set to the desired value, two UCs are defined in order to fairly and meaningfully assess the impact of the BESs:

**Use Case 1: Voltage and Congestion Management:** As RES penetration in the grid increases, more energy is locally generated within several grid areas. Hence, more bidirectional energy flows appear within the grid, creating localised overvoltages and congestions. In this UC, one BES is strategically placed to prevent congestions and voltage fluctuations in the grid. Then, the **BES inverter’s** ability to inject and consume reactive power is utilised for tackling these effects. A further point to note is that the utilisation of BESs in this UC also results in capital expenditure deferrals for the DSOs. In fact, infrastructure upgrades would be required instead of using the BES to allow the higher RES penetration.

**Use Case 2: Peak Shaving and Energy Shifting:** Grid operators of many countries have been adopting a feed-in scheme to pay prosumers for feeding back an excess generation to the grid. This, in turn, has boosted the number of prosumers in the grid, resulting in an increased localised generation (mainly through PV) and hence higher peak loads in the distribution grid. In particular, peaks in energy generation are likely to be offset from the peaks in demand. Therefore, in this UC, multiple BESs are strategically placed to shave the load peaks in the distribution network by storing excess energy and feeding it back when demand exceeds the generation. This energy shift also results in an

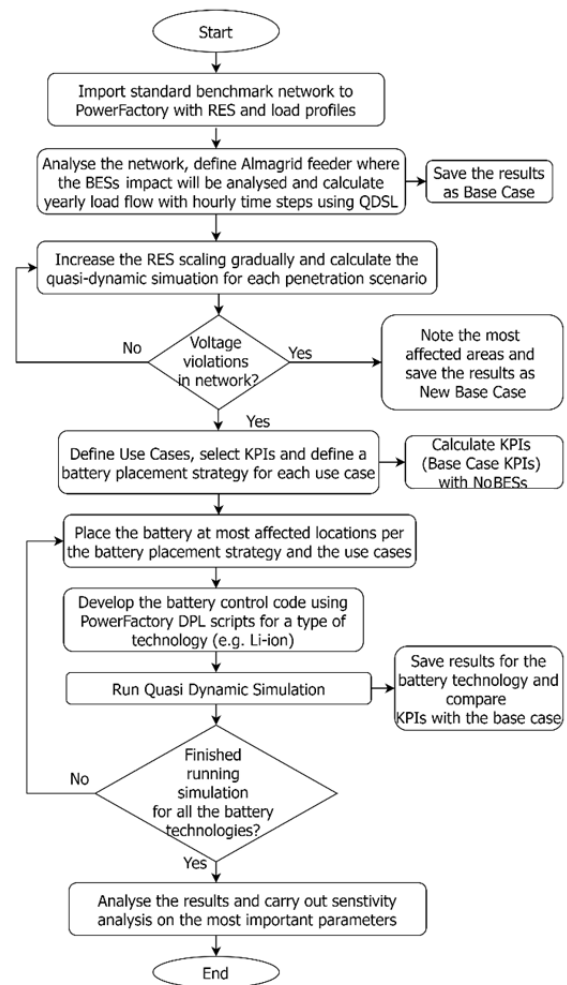

Figure 2: Flowchart of the proposed methodology for assessing and comparing the impact of different BES types.

efficient usage of the local RES generation, which helps in reducing utility bills and generates revenues for prosumers.

### C. Key Performance Indicators

Following the UCs definition, the assessment procedure follows up with the definition of a set of KPIs. In each UC, KPIs are calculated for the base case scenario (no BES), as well as using the three different BES technologies. Results are finally compared to carry out the BES impact assessment and comparison. KPIs selected are discussed below:

**KPI 1, Maximum Voltage:** maximum voltage recorded in the LV network served by the BESs.

**KPI 2, Minimum Voltage:** minimum voltage recorded in the LV network served by the BESs.

**KPI 3, Average bus voltage standard deviation:** average of the individual standard deviations at each bus within the LV network served by the BESs.

**KPI 4, Peak load reduction:** reduction in the peak demand within the distribution area achieved by using the BESs, in comparison to the base case scenario.

**KPI 5, Network losses:** reduction in technical energy losses, essentially copper losses, in the distribution network achieved by using BESs.

**KPI 6, Self-consumption (SC%):** ratio of locally produced electricity that is also consumed locally over the total local electricity production available from the on-site generation units over the horizon period  $T$ :

$$SC_{\%} = \frac{\sum_{t=1}^T (E_t^{demand,local} - E_t^{imported})}{\sum_{t=1}^T E_t^{produced,local}} \quad (1)$$

**KPI 7, Self-sufficiency (SS%):** fraction of the total local consumption that is supplied by local generation within the horizon period  $T$ :

$$SS_{\%} = \frac{\sum_{t=1}^T (E_t^{produced,local} - E_t^{exported})}{\sum_{t=1}^T E_t^{demand,local}} \quad (2)$$

Symbols in (1) and (2) are as follows:

$E_t^{demand,local}$  is the energy consumption in the grid's area being studied at time  $t$ .

$E_t^{produced,local}$  is the energy produced in the grid's area being studied at time  $t$ .

$E_t^{imported}$  is the energy imported from the external network by the grid's area being studied at time  $t$ .

$E_t^{exported}$  is the energy that the grid's area being studied exports to the external network at time  $t$ .

### 3. Battery Placement and Sizing Strategy and Control Logic Description

To effectively evaluate the impact of the BESs in the Almagrid feeder, it is important to place and size them correctly, so that their utilisation is maximised. In order to achieve this goal for each UC, a convenient BESs placement and sizing strategy is followed. This section presents this strategy along with an example of the battery control logic, which remains unchanged for all UCs and BES types. For the sake of completeness, Table I reports the average charge/discharge efficiency considered for the three BES types (provided by manufacturers, which are currently covered by a non-disclosure agreement). A key point to observe, is that BESs are intended to be installed directly by the grid operators, so that each of them is sized according to the grid's necessities.

Table I. –Average efficiency of the three BES types

	Li-ion	RFB (Non-Vanadium-based)	Zn-air
Average Efficiency [%]	97	80	60

#### A. Battery Placement Strategy

For UC1, one centralised BES is placed at the LV bus, where the worst voltage violation has occurred. Initially, the BES is sized based on a fraction (0.33/0.5) of the total active power of the LV bus where it is installed. Then, size is iteratively increased/decreased until all grid violations are eliminated.

For UC2, multiple de-centralised BESs are placed at the LV buses with the highest loads, such that each BES serves a group of prosumers. Initially, each BES is sized based on a fraction (0.33/0.5) of the total active power flow of its the corresponding LV terminal. Then, it is increased/decreased until the peak shaving effects become visible.

The final BESs size for the two UCs is reported in Table II, whereas a graphical representation of the BESs placement in the Almagrid feeder is shown in Appendix 2.

Table II. – BESs size for the two UCs

USE CASE	BESs SIZE [kWh]		
1: Network congestions	150		
2: Peak shaving	<b>Bus #2</b>	<b>Bus #7</b>	<b>Bus #8</b>
	5.3	12	19

#### B. Battery Control

The UCs under consideration require a combination of reactive power management for congestions and voltage regulation, as well as active power management for peak shaving. Therefore, the BES control strategy includes both active and reactive power controls, with both active and reactive power limits being set in such a way as not to overcome the inverter apparent power.

**Reactive Power Control.** Based on the literature, the acceptable operating range for bus voltages is usually between 0.95 p.u. and 1.05 p.u. The BES voltage vs. reactive power control is based on a droop control. In particular, the droop comprises two zones. The first one is between voltages of 0.98 p.u. and 1.02 p.u., where no reactive power is required. The second is set to provide reactive power in a linearly increasing/decreasing manner as the voltage fluctuates between +/-2% and +/-5%. This principle is depicted in the Reactive Power (Q) vs. Voltage (U) in Figure 3.

**Active Power Control.** The active power control is mainly aimed at peak shaving & energy shifting application. To this end, a relatively standard operating principle is depicted in Figure 4, [11]. Here,  $P_{line}$  (solid red line) represents the active power in the upstream line,  $P_{batt}$  (solid green line) is the active power generated by the BES. The charging or discharging of the battery is determined by the storage ( $P_{StartStore}$ ) and feeding ( $P_{StartFeed}$ ) set points, which act as a dead-band within which the battery is idling. Thus,

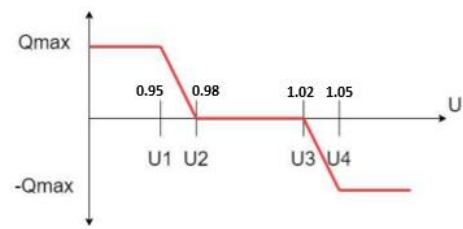

Figure 3: BES reactive power, Q vs U, droop control.

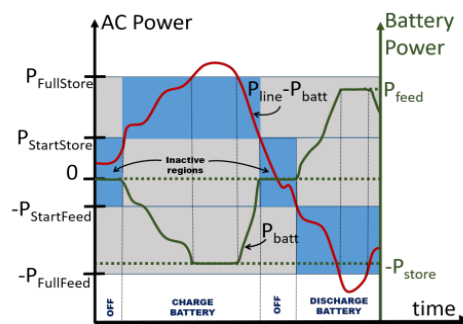

Figure 4: BES active power control.

the battery charges when  $P_{line}$  is above the  $P_{StartStore}$  band and discharges when  $P_{line}$  is below the  $P_{StartFeed}$ .

#### 4. Results and Discussion

This section presents the comparison results between the three types of BES. Firstly, KPIs listed in section 2 are evaluated and analysed before and after the placement of the BESs. Secondly, an economic impact assessment is provided.

##### A. Use Case 1, Network congestions

KPIs evaluated for the UC1 are shown in the spider plot of Figure 5. As can be seen, the placement of a BES in the grid considerably reduces the maximum voltage and improves the minimum voltage. Considering the battery types, Li-ion ones seem to perform slightly better in terms of voltage deviation and average network losses, mostly thanks to their higher efficiency. For the rest of the KPIs, the difference between the three battery technologies is almost negligible. This is due to the fact that BESs performance in this UC is dominated by the reactive power control, where the component having the highest impact is the inverter, which is assumed to be the same for the three BESs.

To further evaluate the impact of the BES installation in the Almagrid feeder, Table III reports the maximum grid voltage together with the number of congestions, where a reduction from 11 to zero may be observed.

Table III. –UC1 maximum voltage and number of congestions

	No BES	UC1		
		Li-ion	RFB	Zn-air
Max. Voltage [p.u.]	1.053	1.0480	1.0484	1.0485
Number of grid congestions	11	0	0	0

##### B. Use Case 2, Peak shaving

KPIs evaluated for the UC2 are shown in the spider plot of Figure 6. In this case, the most important KPIs to analyse are peak load reduction, self-consumption and self-sufficiency. As it is shown in Table IV, the peak load in the LV line upstream of the BESs is reduced by 5% with Li-ion and by 4% with Zinc-Air and RFB compared to the base case.

Table IV. –UC2 maximum voltage and number of congestions

	No BES	UC2		
		Li-ion	RFB	Zn-air
Peak Load Reduction [%]	N/A	5	4	4
Self-consumption [%]	52.75	60.81	58.86	57.83
Self-sufficiency [%]	34.72	44.56	38.9	37.26

An example of peak shaving upstream LV line is shown in Figure 7 for Li-ion technology. Self-consumption and self-

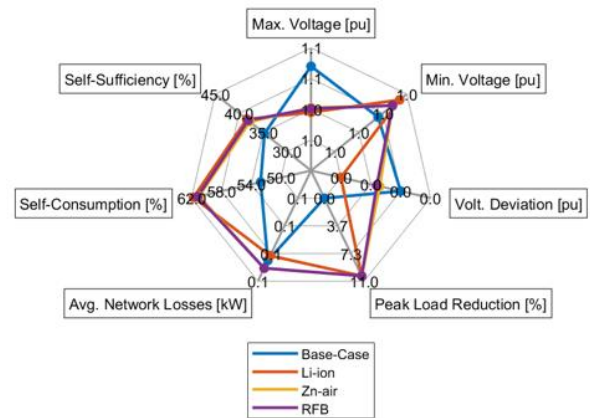

Figure 5: KPIs for UC1.

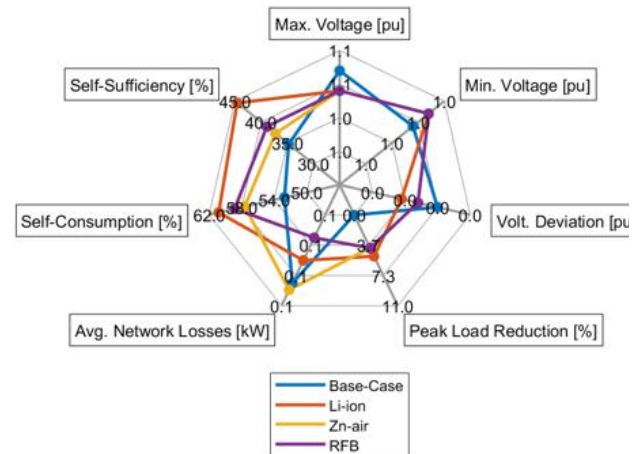

Figure 6: KPIs for UC2.

sufficiency in the local network see an absolute increase in the range of 5% to 8% and 5% to 10% respectively, using BESs compared to the base case. Indeed, BESs increase the utilisation of local generation to meet local demand by energy shifting. Since Li-ion battery are the most efficient battery type and this UC is dominated by the active power control, this battery type shows the highest reduction in peak load and increase in self-consumption and self-sufficiency.

##### C. Economic Impact Analysis

In order to fully and meaningfully assess the impact of the BESs placement, a final step to take is to evaluate their economic viability for the two UCs.

Table V and Table VI present the total project cost (capital + installation and commissioning costs) of the three BES technologies for UC1 and UC2, respectively, based on the pricing data provided in [12] and the BES sizing from Table II. Table V also presents the calculated lifetime of the BES in UC1. This is evaluated as the ratio between the design life cycles at 100% DoD over the number of equivalent cycles at 100% DoD used by the battery in 1 year, [12].

These estimations are relatively optimistic, since the actual BES rate of degradation also depends on the aging of the internal chemistry, whose assessment is quite complex and is beyond the scope of this work. Based on the data provided in Table V, Li-ion technology is currently the cheapest of the three types, although RFB technology has a considerably higher design life cycles compared to Li-ion and Zn-air technologies. This also manifests in the form of

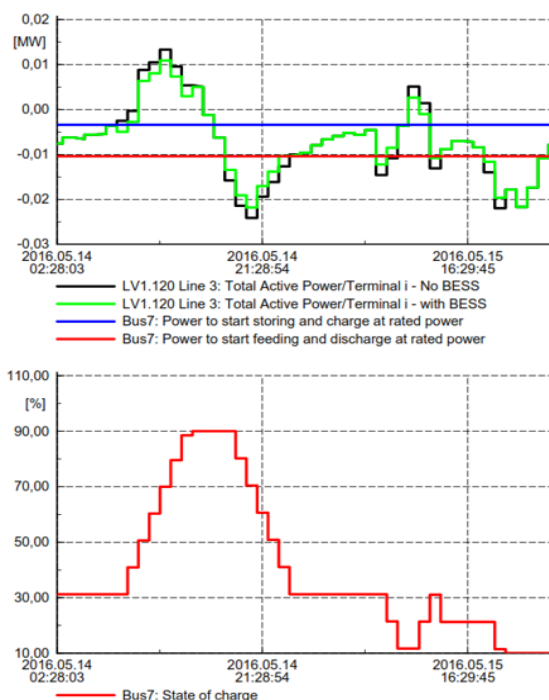

Figure 7: Peak Shaving example for the Li-ion BES.

higher calculated life (80 years vs 40 / 28 years). This feature can potentially make RFB technologies economically sustainable for long-term applications in future.

In UC2, the economic benefits for prosumers of using BESS for peak shaving and energy shifting can be quantified in terms of the reduction in electricity costs. Table VII shows the annual electricity cost savings from using BESS, evaluated based on peak, off-peak and feed-in pricing from the EU commission's statistics. Cost savings were calculated only for Li-ion and RFB (due to data available). Li-ion technology resulted in highest cost savings, again due to a better efficiency compared to RFB.

Table V. – UC1: Project costs and calculated lifetime of the BESS

Li-ion		RFB		Zn-air	
Calc. Lifetime [years]	Cost [k€]	Calc. Lifetime [years]	Cost [k€]	Calc. Lifetime [years]	Cost [k€]
40	60	80	75	28	111

Table VI. – UC2: Costs of the BESS

Li-ion			RFB			Zn-air		
Project cost [k€]								
Bus #2	Bus #7	Bus #8	Bus #2	Bus #7	Bus #8	Bus #2	Bus #7	Bus #8
2,1	4,8	7,6	2,6	6,1	9,5	3,9	9,1	14,2

Table VII. – Annual cost savings by using BESS in UC2

BES Type	Bus #2	Bus #7	Bus #8
Li-ion	286 €/year	1113 €/year	1097 €/year
RFB	180 €/year	940 €/year	683 €/year

## 5. Conclusion

This work has presented a fair and meaningful assessment and comparison of the impact of Li-ion, Zn-air and RFB

battery types in a real distribution grid with a high RES penetration.

When dealing with voltage management and grid congestion, no significant differences between the BES types are observed, as it only depends on the inverter capability of producing reactive power.

When dealing with peak shaving and energy shifting, BESS placement allowed to reduce the peak load by 4% to 5%, whilst self-consumption and self-sufficiency observe an increase in the range of 5% to 10%. In this case, Li-ion BESS was found to be the most effective both technically and economically. However, considering the large scale and longer-term applications, RFBs are proven to possess the potential to compete with Li-ion ones in the near future. In future work, more advanced battery models need to be developed and included in the proposed assessment methodology, so that further difference between BES types apart from efficiency can be taken into account.

## Acknowledgement

This work has been realised from the S. P. Surve's Master Thesis at the European Master in Renewable Energy coordinated by EUREC (Association of European Renewable Energy Research Centres). This research work is part of the PARITY project, which has received funding from the European Union's Horizon 2020 programme under grant agreement No 864319.

Eventually, Authors would also like to acknowledge all partners from the ALMAGRID Project "Integración de tecnologías avanzadas de almacenamiento de energía para aplicaciones de red" (exp. CER-2019100).

## References

- [1] K. M. Tan, T. S. Babu, V. K. Ramachandramurthy, P. Kasinathan, S. G. Solanki, and S. K. Raveendran, "Empowering smart grid: A comprehensive review of energy storage technology and application with renewable energy integration," *Journal of Energy Storage*, vol. 39, p. 102591, 2021.
- [2] R. Rocca, S. Papadopoulos, M. Rashed, G. Prassinis, F. Giulii Capponi, and M. Galea, "Design Trade-Offs and Feasibility Assessment of a Novel One-Body, Laminated-Rotor Flywheel Switched Reluctance Machine," *Energies*, vol. 13, no. 22, 2020.
- [3] D. Marcos, M. Garmendia, J. Crego, and J. A. Cortajarena, "Hazard and Risk Analysis on Lithium-based Batteries Oriented to Battery Management System Design," in *2020 IEEE Vehicle Power and Propulsion Conference (VPPC)*, 2020, pp. 1–6.
- [4] W. Yu *et al.*, "Elucidating the mechanism of discharge performance improvement in zinc-air flow batteries: A combination of experimental and modeling investigations," *Journal of Energy Storage*, vol. 40, p. 102779, 2021.
- [5] E. Sánchez-Díez *et al.*, "Redox flow batteries: Status and perspective towards sustainable stationary energy storage," *Journal of Power Sources*, vol. 481, p. 228804, 2021.
- [6] A. Karrech, K. Regenauer-Lieb, and F. Abbassi, "Vanadium flow batteries at variable flow rates," *Journal of Energy Storage*, vol. 45, p. 103623, 2022.
- [7] G. Fernández *et al.*, "Optimal demand-side management with a multi-technology battery storage system," *Renewable Energy and Power Quality Journal*, vol. 1, no. 16, pp. 345–349, Apr. 2018.
- [8] EU-H2020 I-Electrix, "Minimal set of use case KPIs and measurement methods to perform the technical and economic analysis of the resulting definitions," 2019.

[9] PowerFactory - DIgSILENT, "https://www.digsilent.de/en/powerfactory.html."  
 [10] SimBench, "https://simbench.de/en/download/datasets/"  
 [11] DigSilent PowerFactory, "User Manual." Germany, 2020.

[12] K. Mongird *et al.*, "Energy Storage Technology and Cost Characterization Report," USA, 2019.

### Appendix 1

This Appendix describes the network schematic and the main Almagrid Feeder Characteristics. The Simbench grid outlook plus the Almagrid feeder are shown in Figure 8, whereas the feeder characteristics are provided in Table VIII.

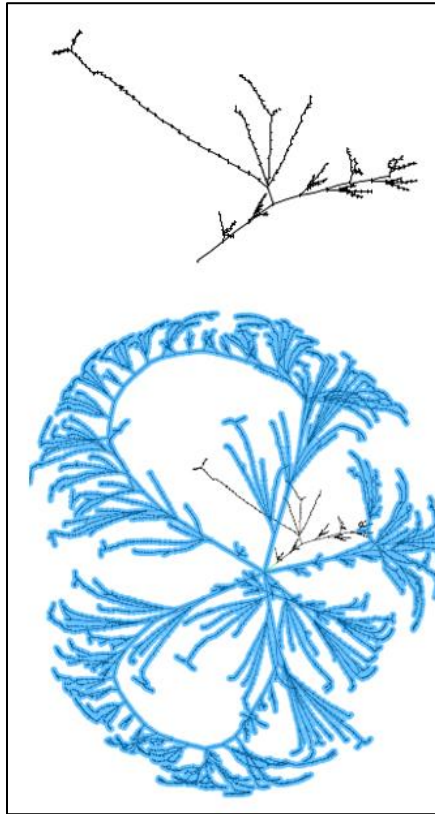

Figure 8: Simbench grid outlook plus Almagrid feeder.

Table VIII. – Almagrid feeder characteristics

COMPONENTS	DESCRIPTION	NUMBER
HV_MV Substation	20 kV	1
Transformer	0.25 MVA, 20/0.4 kV	1
Transformer	0.16 MVA, 20/0.4 kV	7
<b>Total</b>		<b>9</b>
MV-Generators	PV, Hydro and Biogas	3 (1 per type)
LV-Generators	PV	36
<b>Total</b>		<b>39</b>
MV-Lines	-	5
LV-Lines	-	189
<b>Total</b>		<b>194</b>
MV-Buses		8
LV-Buses		194
<b>Total</b>		<b>202</b>
<b>Prosumers</b>		<b>190</b>

### Appendix 2

This Appendix describes the BES placement for the UC1, centralised BES Figure 9 (a), and UC2, decentralised BES, Figure 9 (b).

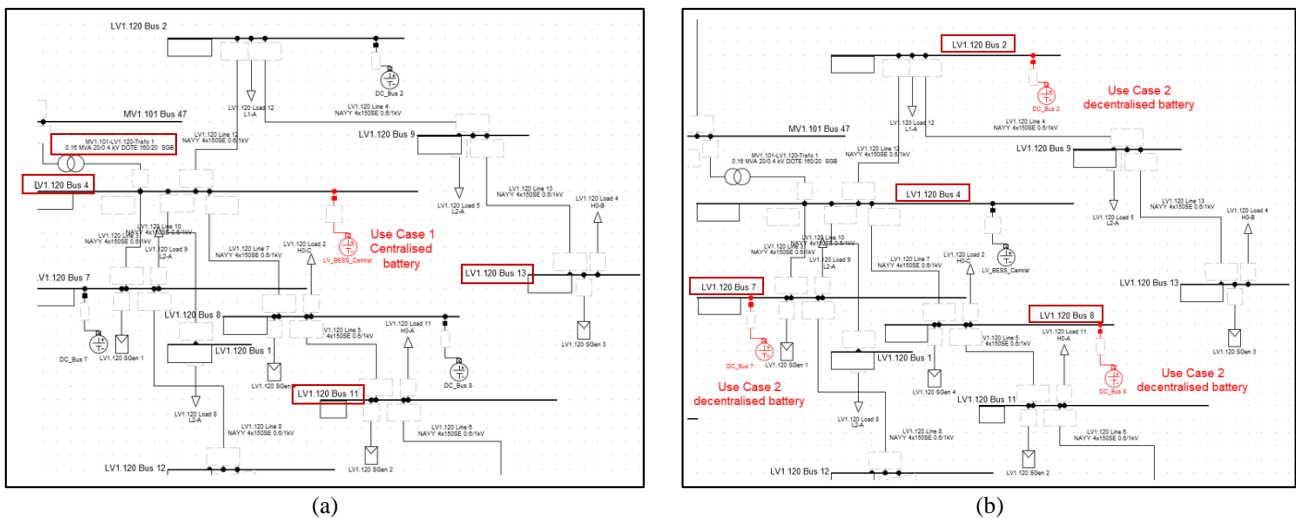

Figure 9: BES placement for the UC1 (a), centralised BES, and UC2 (b), decentralised BES.