

ANEXOS

Anexo 1: cartografía geológica del área de estudio.

Anexo 2: representación gráfica de todos los perfiles estratigráficos.

Anexo 1

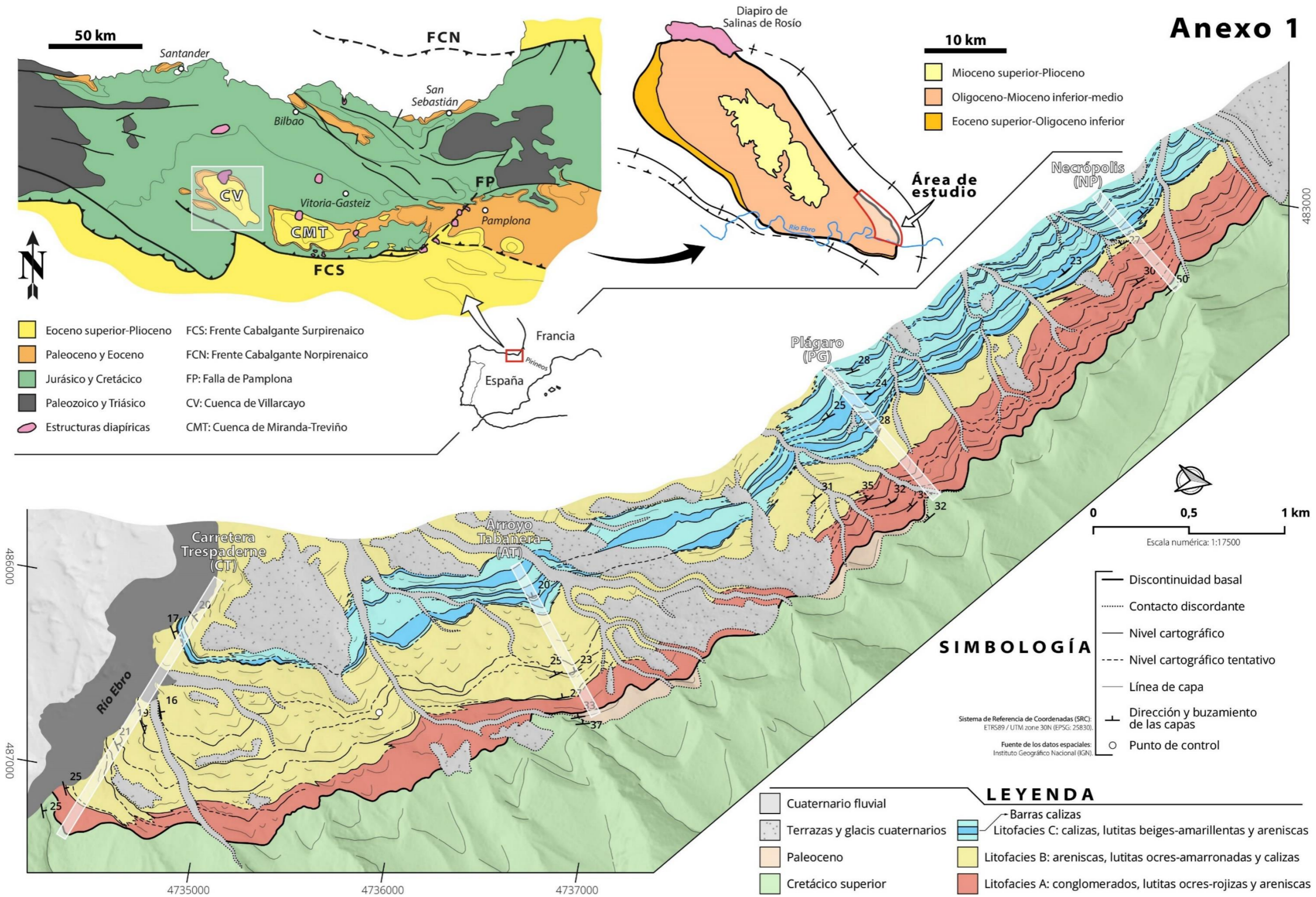





Anexo 2



Litologías

-  Conglomerados
-  Lutitas
-  Areniscas
-  Calizas arenosas y limosas
-  Limolitas
-  Calizas

Estructuras sedimentarias

-  Estratificación cruzada en surco
-  Estratificación cruzada planar
-  Bioturbación por raíces
-  Nódulos de carbonato cálcico
-  Estructura prismática

Otros

-  Oncolitos
-  Fragmentos de plantas
-  Paleocorrientes

Organización de la información

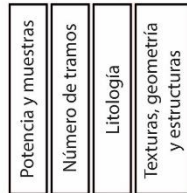

Escala vertical: 1:250 (m)

Escala horizontal:

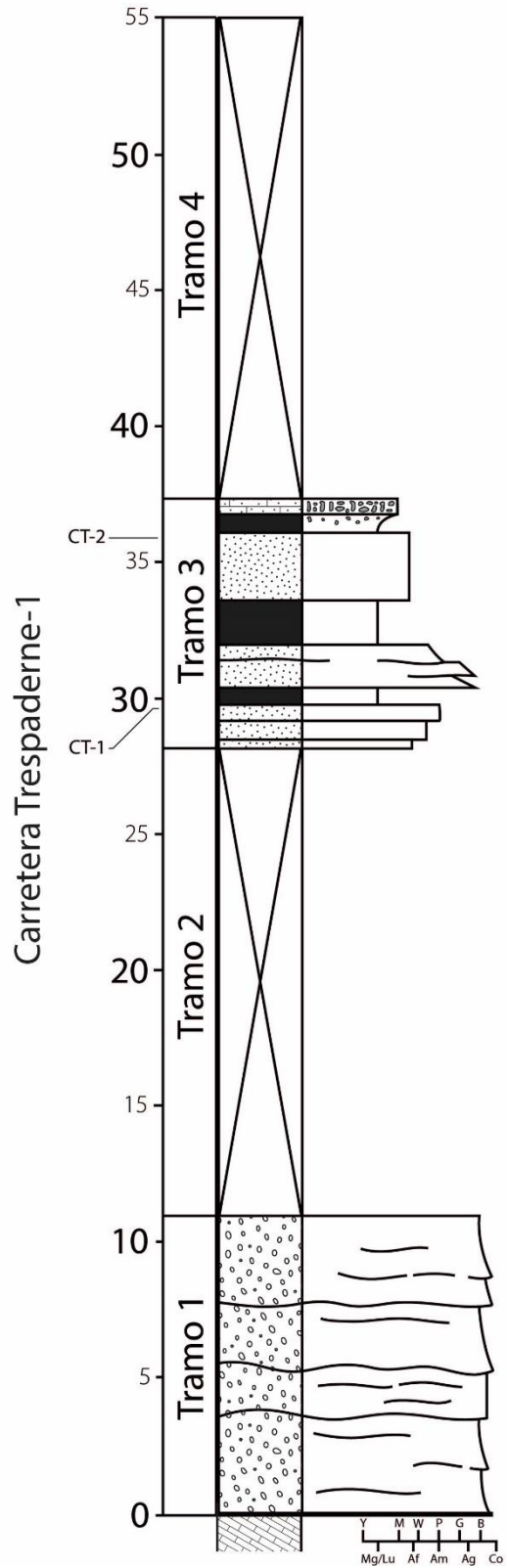
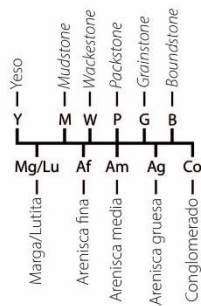

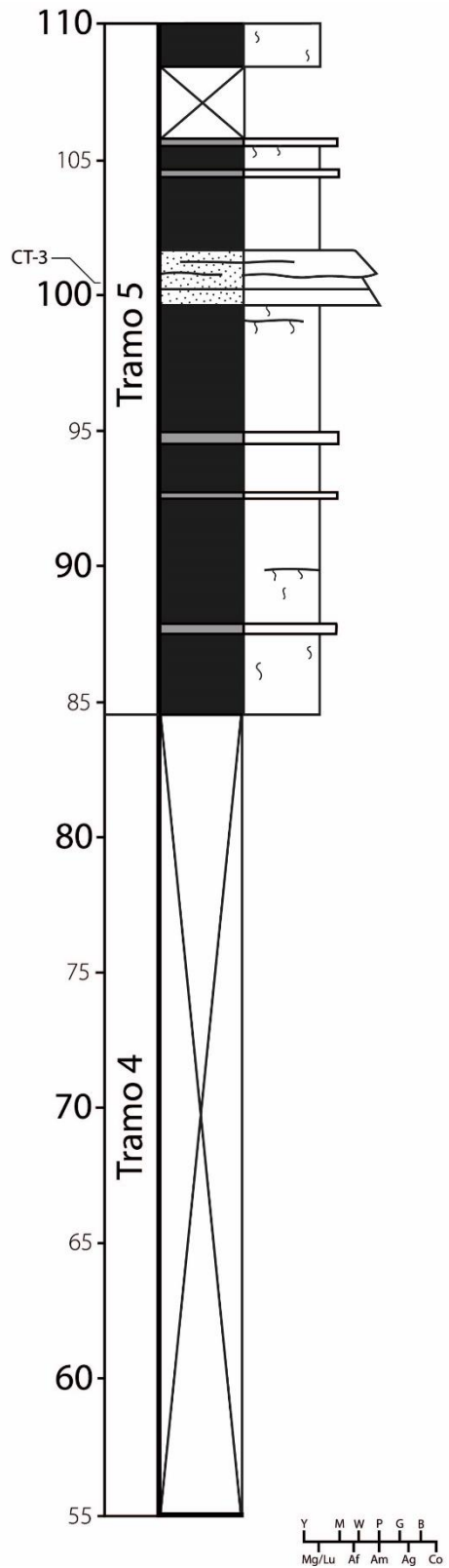

Carretera Trespaderne-2

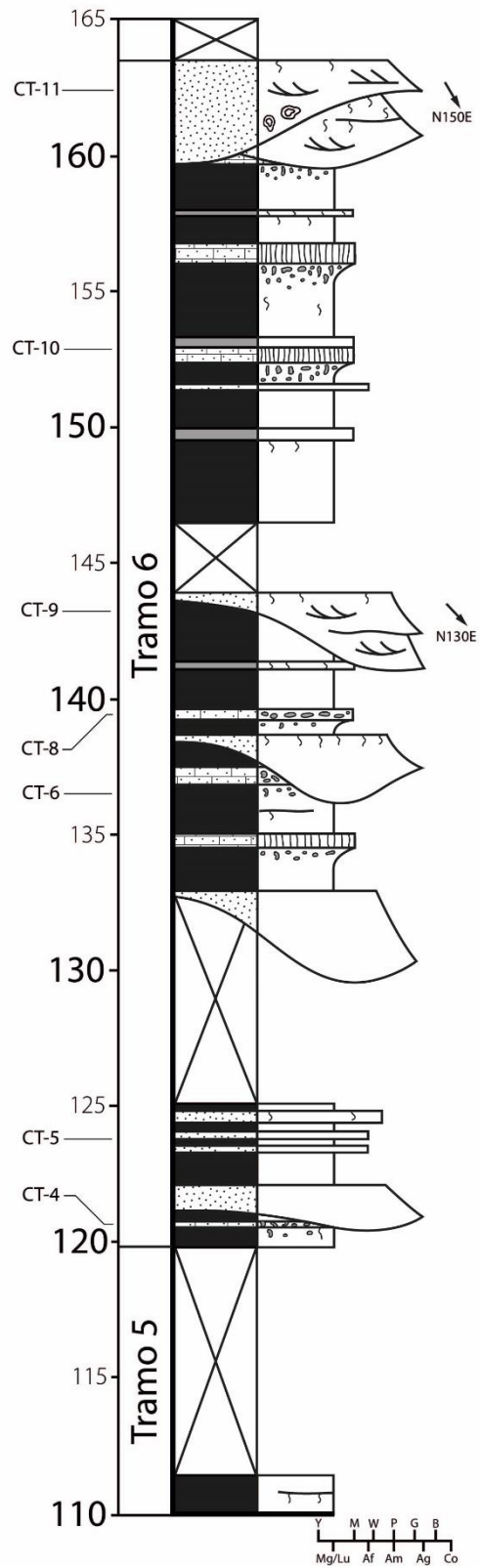

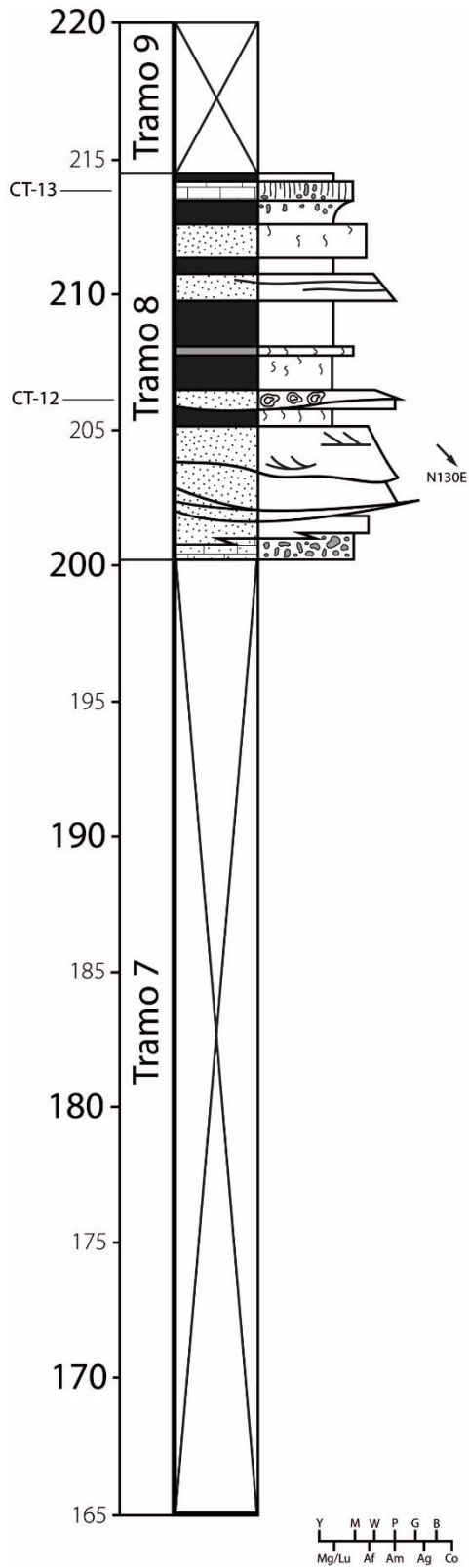

Carretera Trespaderne-3

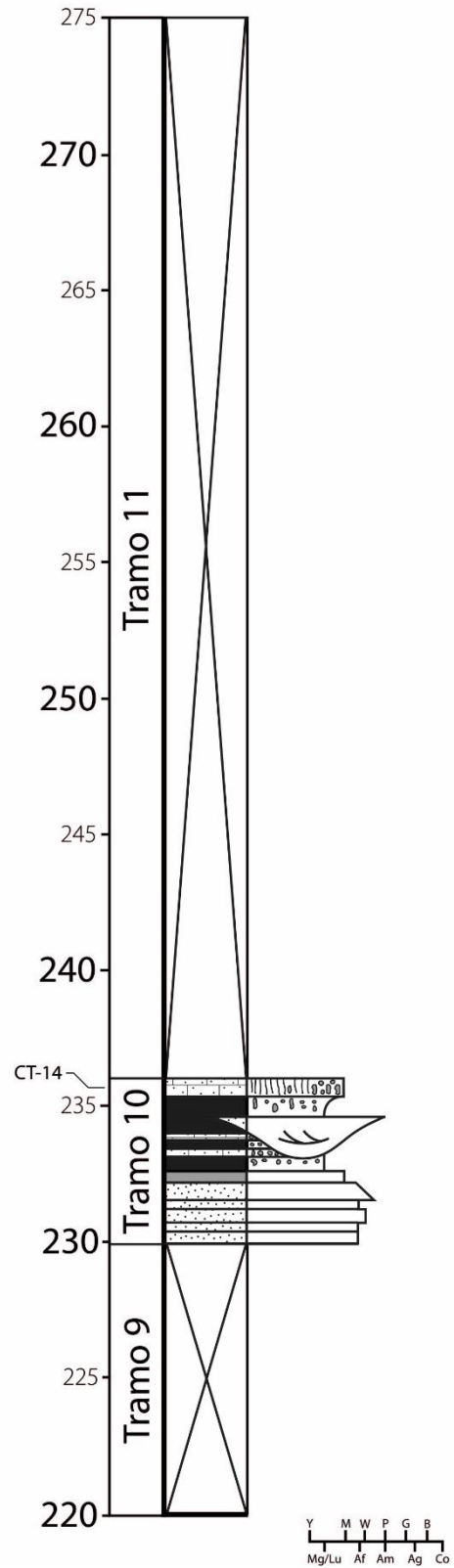

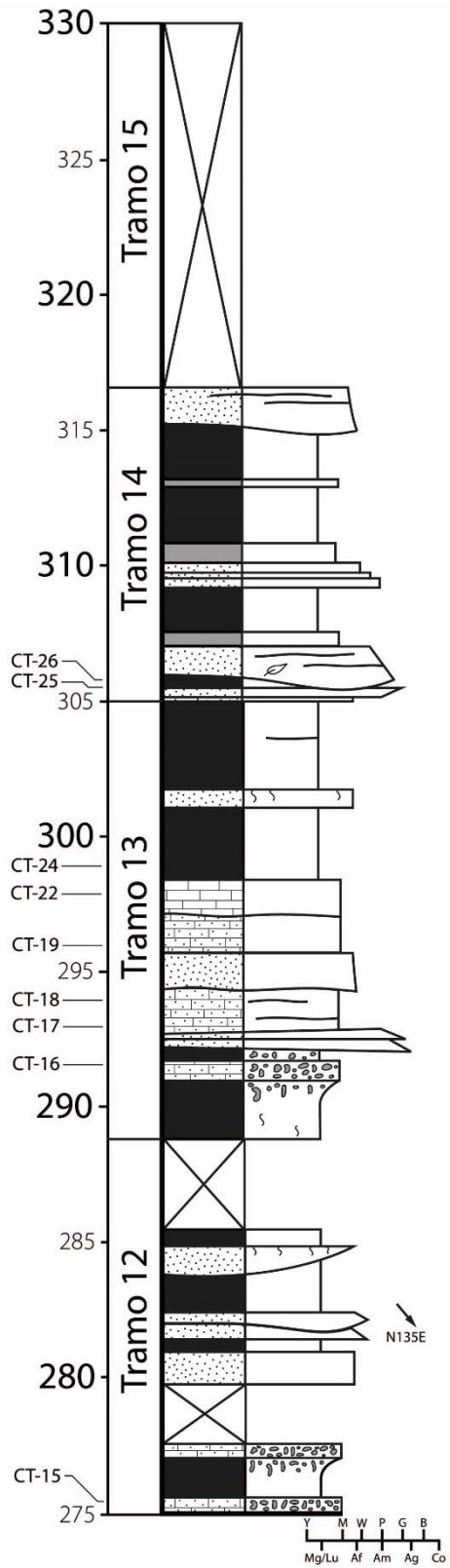

Carretera Trespaderne-4

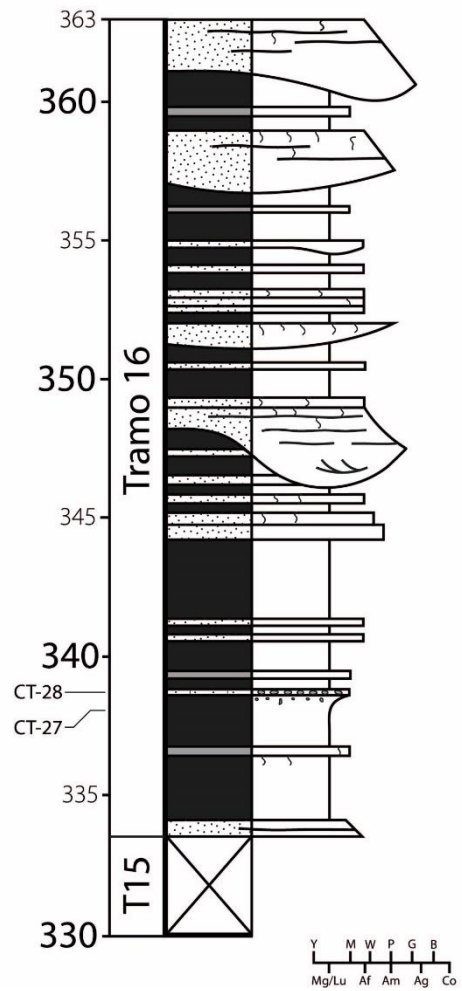

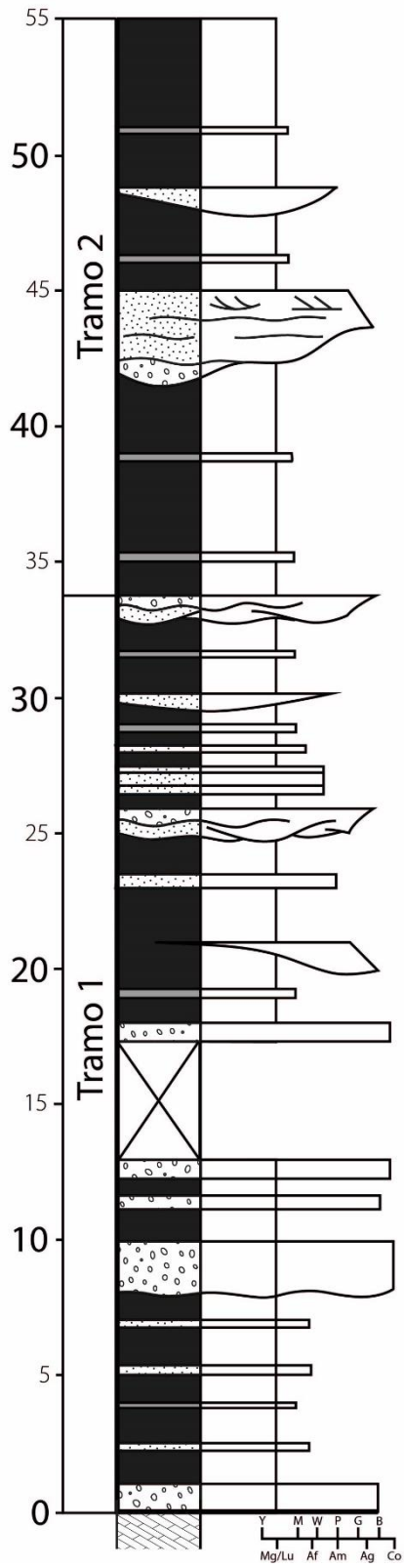

Arroyo Tabanera-1

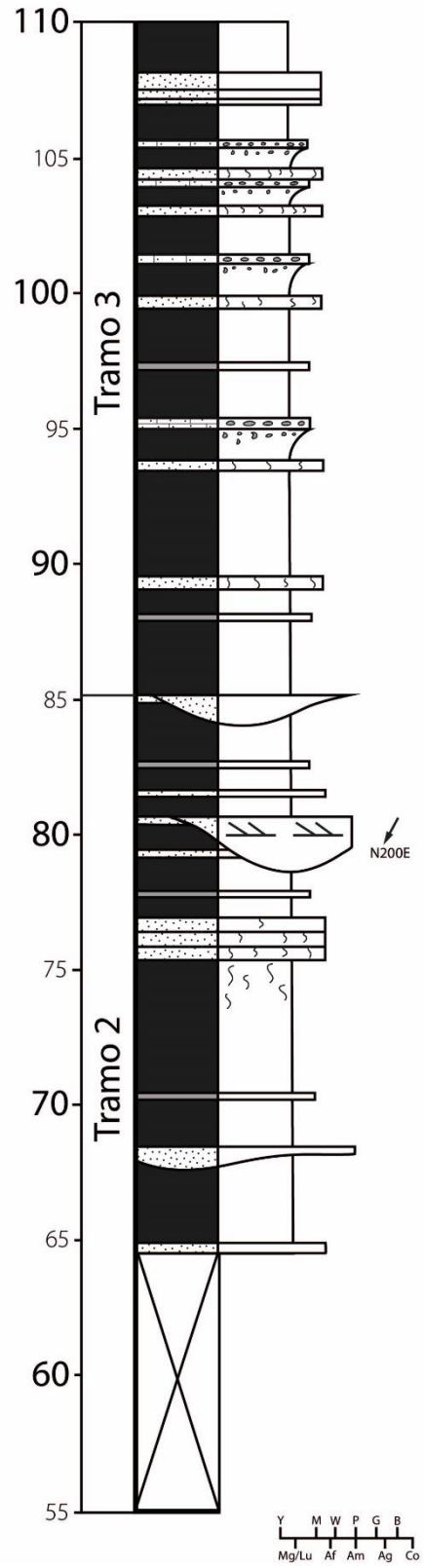

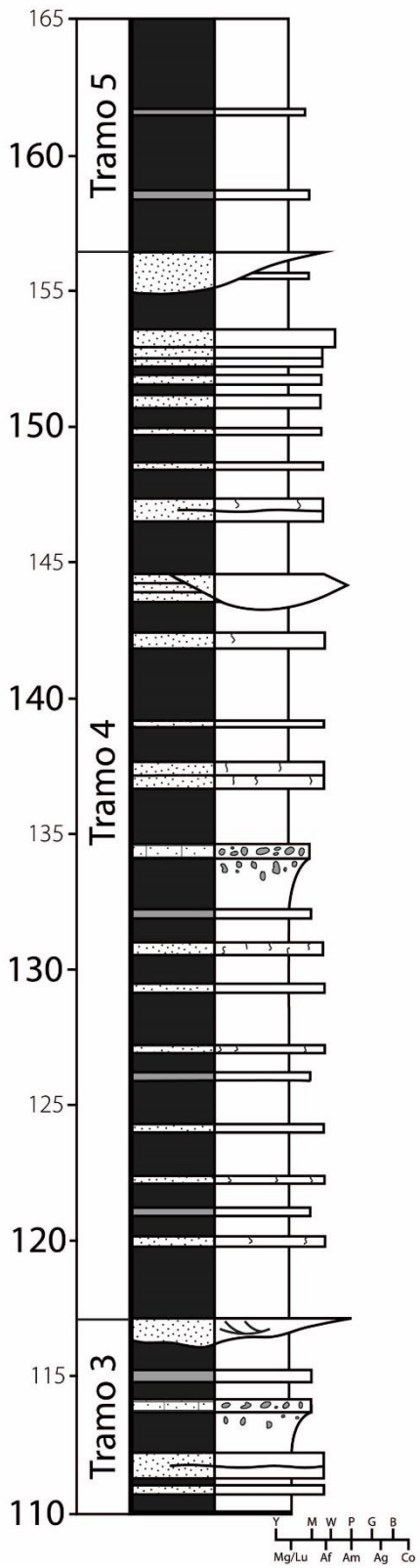

Arroyo Tabanera-2

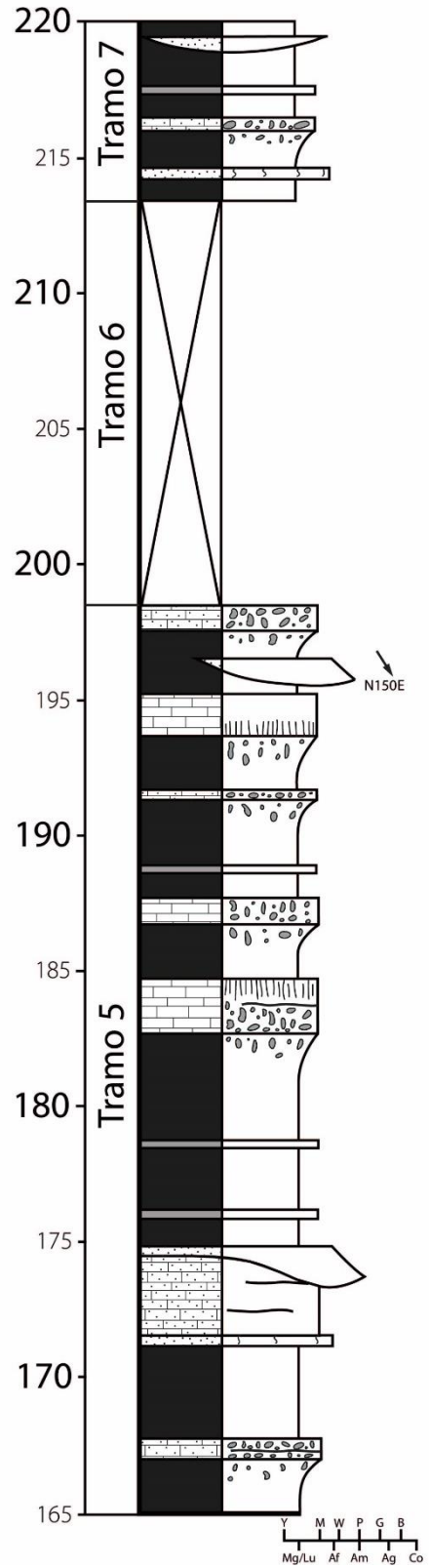

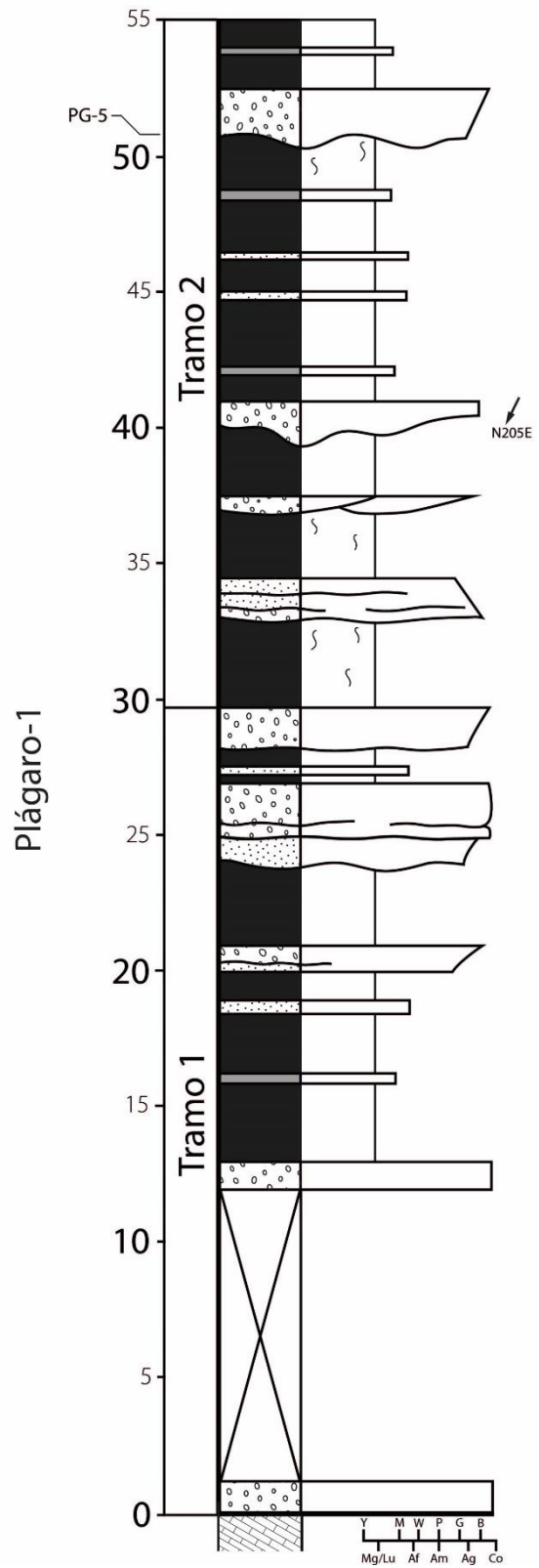
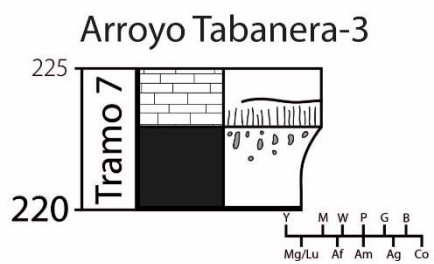

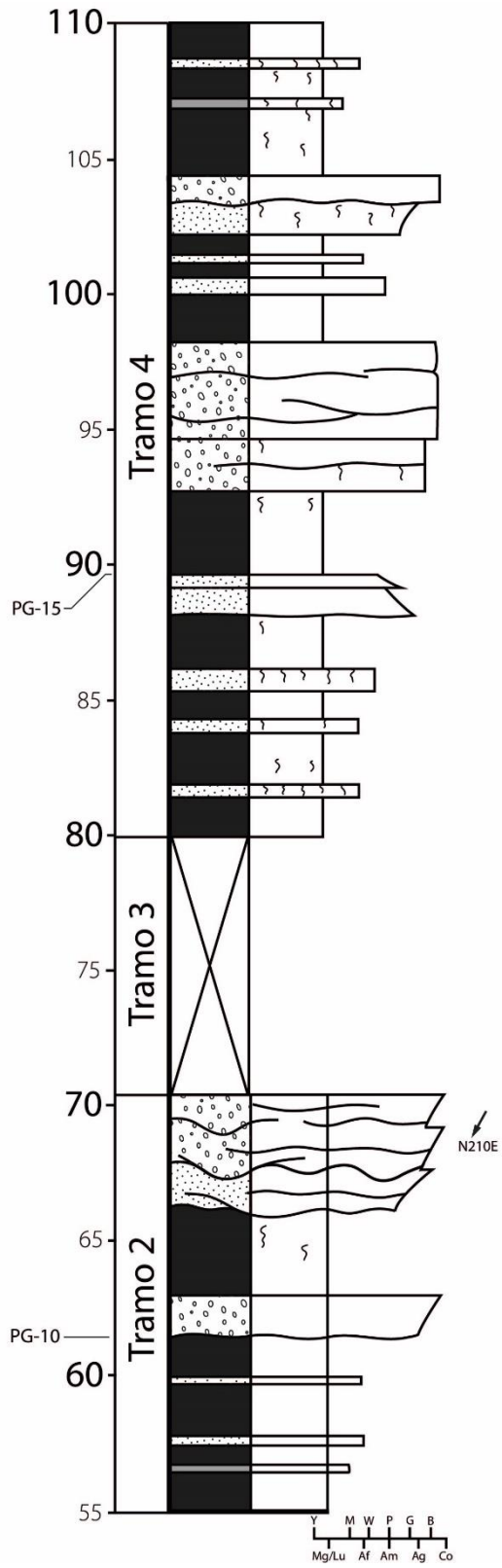

Plágaro-2

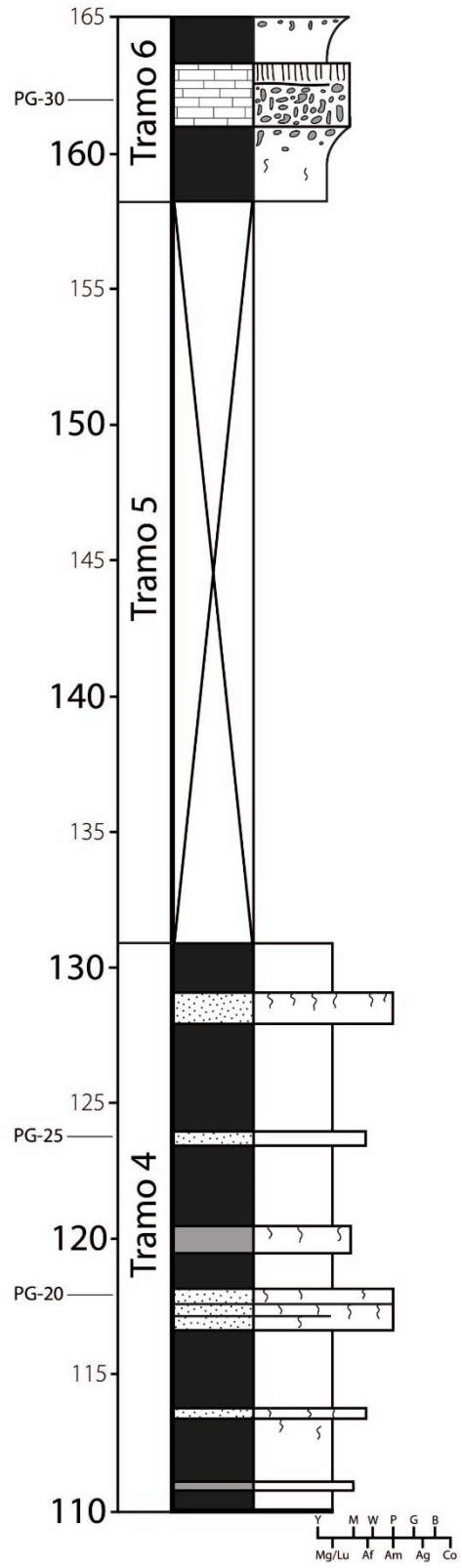

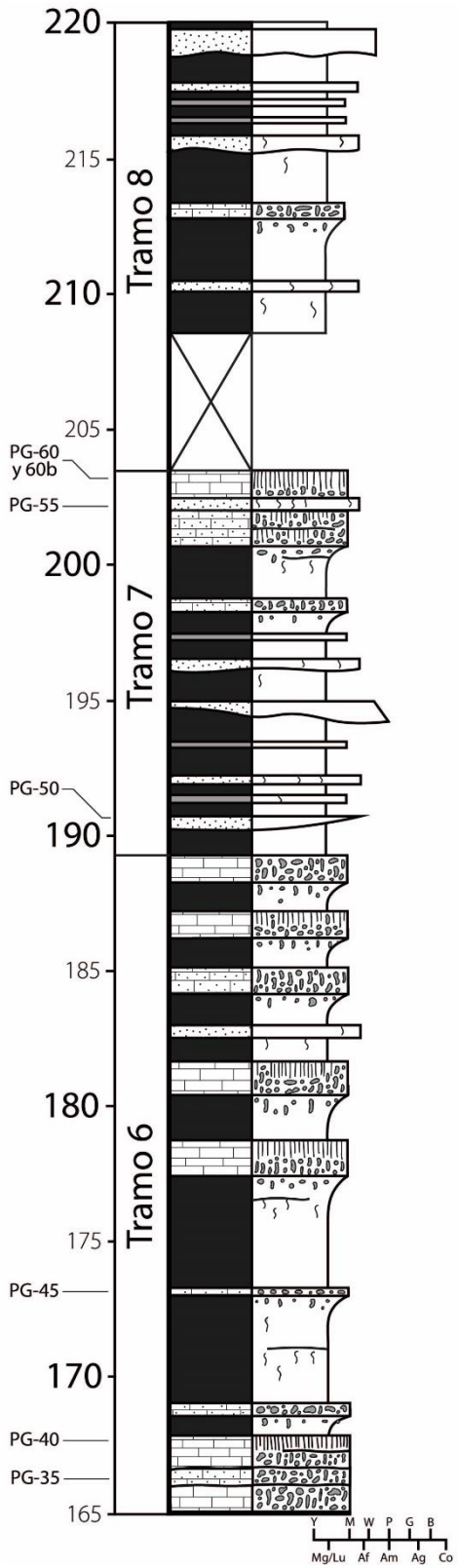

Plágaro-3

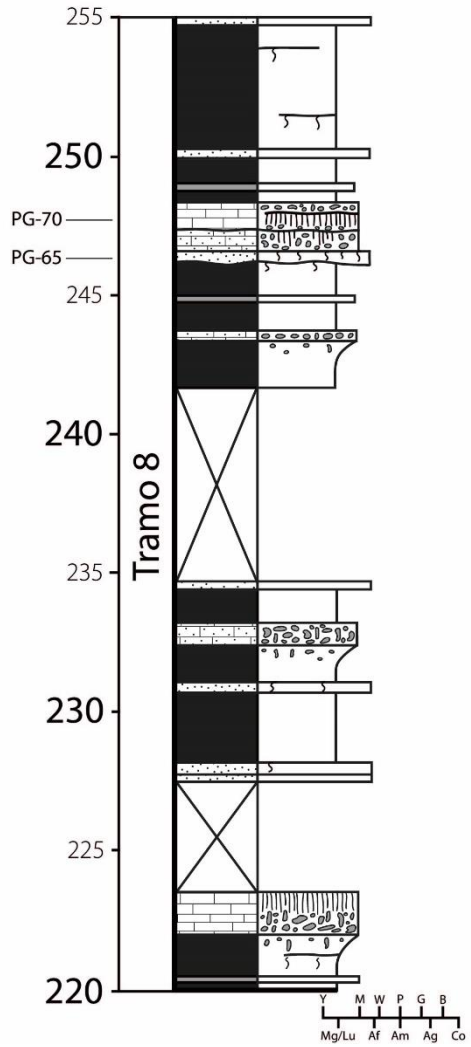

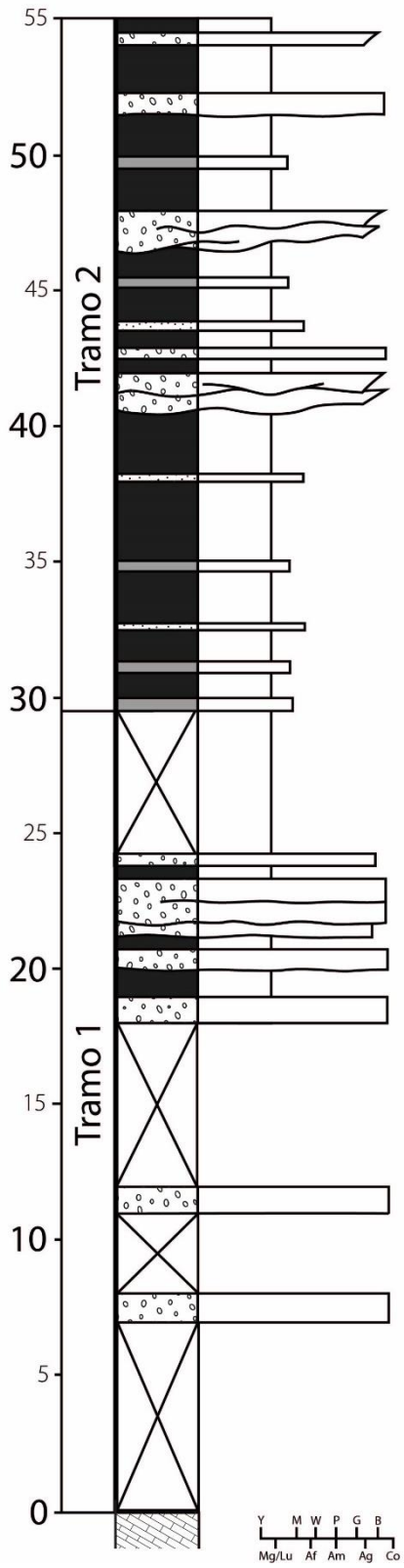

Necrópolis-1

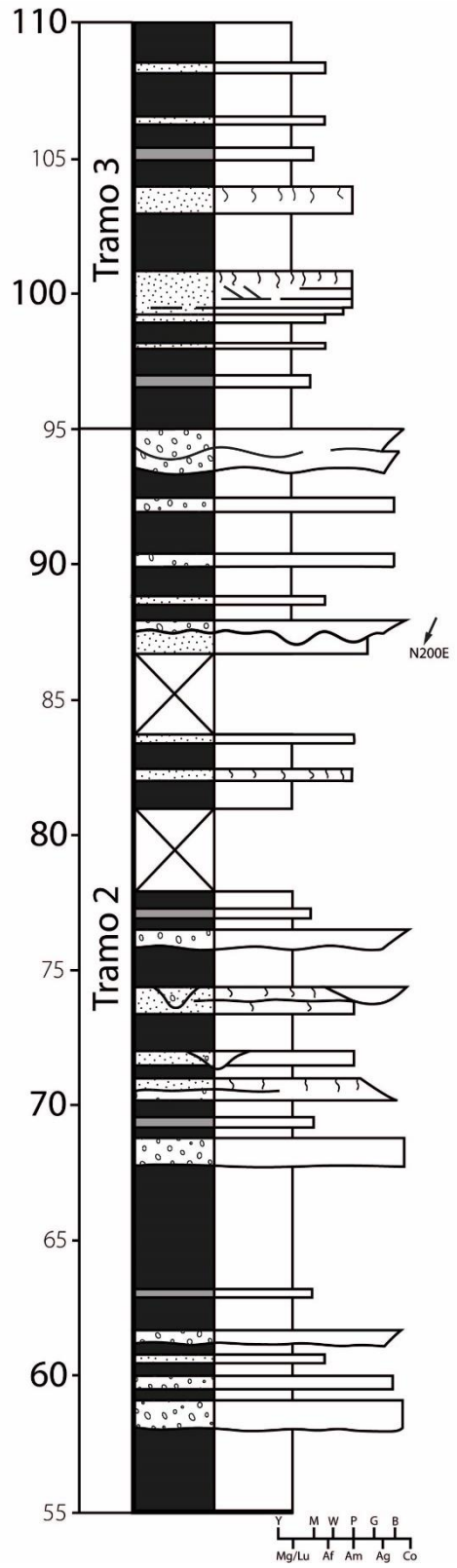

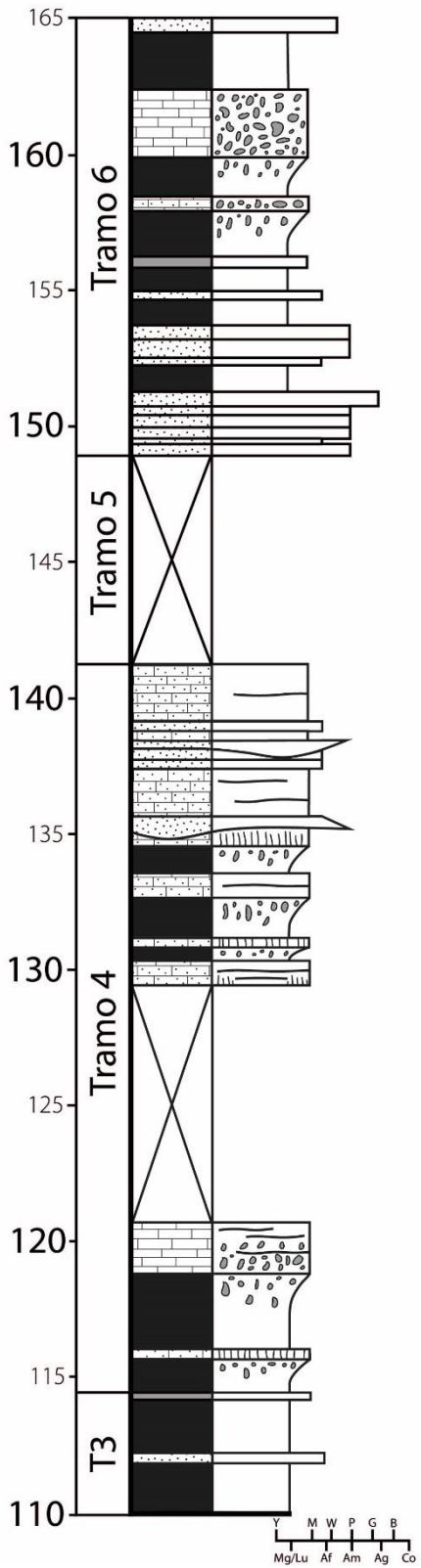

Necrópolis-2

