

## Research Article

# Motorcyclist Protection Systems: Analysis of the Crash Test Tolerances of the European Technical Specification and the Spanish Standard

**Ramon Miralbes**

*Design and Manufacturing Department and DIDYE, University of Zaragoza, C/María de Luna s/n, 50017 Zaragoza, Spain*

Correspondence should be addressed to Ramon Miralbes; miralbes@unizar.es

Received 19 May 2014; Revised 22 September 2014; Accepted 7 October 2014

Academic Editor: Farzad Ebrahimi

Copyright © Ramon Miralbes. This is an open access article distributed under the Creative Commons Attribution License, which permits unrestricted use, distribution, and reproduction in any medium, provided the original work is properly cited.

One of the most frequent and harmful kinds of motorcycle accidents is an impact against the post of the roadside barrier, so designers have developed some motorcyclist protection system (MPS) to reduce it. Some countries have developed a standard testing procedure, like the Spanish UNE-135900-2008 standard, identical to the CEN's recently approved Technical Specification (TS 1317-8). These standards specify the test procedure to obtain the behaviour of the MPS, but experimental tests have shown some dispersion of results for identical tests of the same barrier. There are some theories to explain this but the most reasonable is the influence of tolerances of some of the test variables in the final result like impact height, impact velocity, yaw angle, and mass. To analyze these theories, numerical analysis that can measure the independent influence of each parameter in the results has been used, using a correlated numerical model, a common and experimentally tested barrier, and an MPS. So, the results of this paper show how some parameters of impact significantly influence the behaviour of the system, changing impact severity, potential damage, and injuries. Therefore, the test tolerances do not guarantee repeatability and can accept systems too harmful for the same test conditions, so it will be necessary to reduce limit deviations of some impact variables.

## 1. Introduction

A high percentage of traffic accidents involve motorcycles (17.22%); of these motorcyclist collisions, 32.7% were fatal, and 50% of those were primarily due to victims' impact on hazardous roadside objects, such as poles, trees, walls, or embankments (deaths). Motorcyclists had such collisions seven times more often than other motor vehicle occupants and the risk of death is about 20 times higher than other motor vehicles accidents [1].

When a vehicle departs from the roadway, the severity of the accident can be reduced by removing obstacles or by installing appropriate protective devices like road restraint systems (RRS) that redirect and contain errant vehicles. But they can be potentially dangerous for one of the most vulnerable users of the road, the motorcyclists or powered two-wheelers (PTW), because the RRS and barriers include some roadside installation devices especially harmful for motorcyclists [2–7].

Roadside impacts make riders more likely to suffer injuries in their upper and lower extremities and vital regions of the body, such as the spine, head, and thorax [8–11]. Road-sides are equipped with continuous or punctual motorcyclist protection systems (MPS) [12].

Additionally, new standards and regulations have come into use to evaluate the level of protection that punctual and continuous retaining systems offer. Currently, the Spanish UNE-135900-2008 standard is considered a reference for MPS and is identical to CEN's recently approved Technical Specification (TS 1317-8) but there are two other previous protocols in Europe: the LIER (INRET'S Road Equipment Test Laboratory, France) and the BAST (Federal Highway Research Institute, Germany).

These real simulations are usually expensive and time-consuming, so finite-element models had been emerging as a means to analyse crash or impact events with high detail and low cost and without the need to construct a prototype of the MPS [13] or the RRS [14].

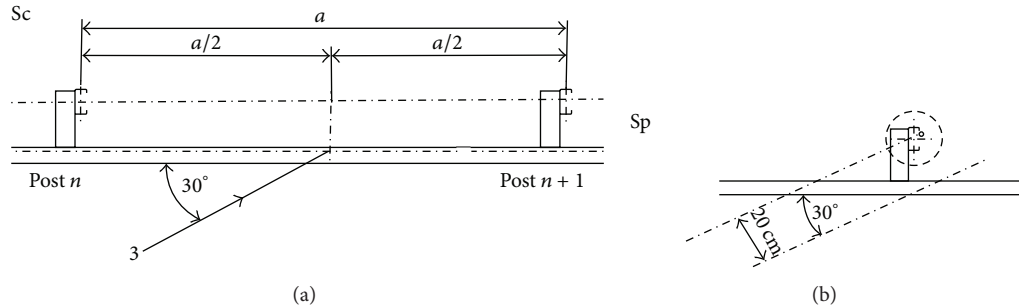

FIGURE 1: UNE-EN-135900 test against vane (a) and post (b) centre and eccentric.

Basically the testing procedure simulates a motorcyclist sliding (after separation from the powered two-wheelers) on the road at high velocities (above 60 km/h), without the motorcycle, and crashing into the MPS [12], but because of the limitations of the precision of a real test there are some variables that must be in a range that specify the standard. But is this range adequate or not? What is the final influence of each variable? Some experimental results have demonstrated variability for the same barrier from one test to another, most likely due to the range of tolerances in the final result.

Trying to answer this question, the following objectives were proposed for this paper:

- (1) analysis of the TS 1317-8 and the UNE-135900-2008 to identify the weakness related to inadequate definition of physical parameters or their deviation,
- (2) independent validated virtual tests analysing each range of physical parameters,
- (3) modifications of testing procedures and range of tolerances if weaknesses are detected.

## 2. TS 1317-8 for the Roadside Motorcyclist Protective Devices

The TS-1317-8 establishes the crash test procedure and the requirements for the approval of punctual and continuous MPS. It is copied from the 2005 Spanish standard (UNE 135900-2008) [15].

In this test, a Hybrid III 50th percentile dummy is equipped with a 1.3 kg integral helmet and a leather motorcyclist suit. The dummy then is launched against a guardrail with an attached MPS, sliding on the floor at a speed of 60 km/h and an impact angle of 30°. The dummy slides toward the barrier, lying flat with its back on the ground. In one test of continuous MPS, the dummy is launched toward the centre of the guardrail post, and in the other, it is launched toward the middle of the span between two consecutive posts (Figure 1), with the former generally being the most unfavorable situation.

For punctual MPS there are another two test procedures: one is launched toward the centre of the guardrail post again and the other toward an eccentric point of the post. Punctual MPS are not now in use because they offer less protection than continuous MPS and do not avoid the impact against other roadside objects. Punctual MPS are devices that are installed

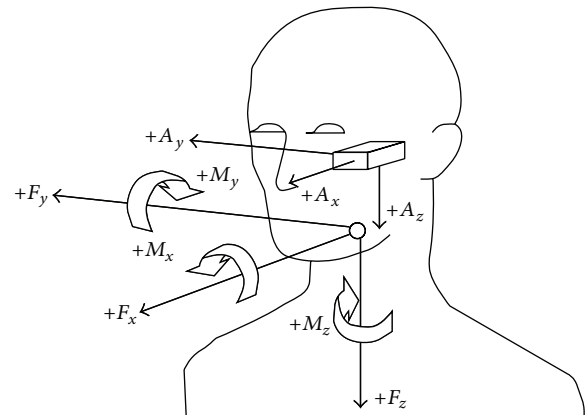

FIGURE 2: Forces, moments, and accelerations directions in the UNE-EN-135900 test.

in the barrier post and around it but they only protect the motorcyclist against an impact with the post and so now are not used and this paper does not study them.

The full height safety barrier is 60 metres long, with 15 posts 4 metres apart. At the beginning and end, the guardrail was dipped into the ground over a distance of 12 metres, consisting of 6 poles 2 metres apart.

Analysis should cover the following injury criteria: the head injury criterion (HIC), the forces in the neck ( $F_x$ ,  $F_{z,traction}$ , and  $F_{z,compression}$ ), and the occipital condyle movements ( $M_{cox}$ ,  $M_{coy,extension}$ , and  $M_{coy,flexion}$ ) (Figure 2). The  $HIC_{36}$  is an injury criterion that evaluates brain damage from a crash.

To get the required speed and trajectory the dummy is put on a guided trolley with the desired speed and direction. A few metres before the point of impact the trolley stops and the dummy falls out of it and slides on the floor. In this way, during the approach path, the dummy bounces slightly while the neck rotates. The movements of the dummy and the neck rotation make some variables vary slightly from one test to another. These impact parameters and their tolerance range (defined in the testing protocol/regulation) are as follows:

- (i) impact velocity: 60 km/h [+0, +6%];
- (ii) impact height ( $z$ ): [-60 mm, +60 mm], depending on the W-profile position above the ground and the height;
- (iii) impact angle:  $30^\circ \pm 2^\circ$ ;

TABLE 1: Maximum values of dummy measurement for the two classes of severity.

	HIC <sub>36</sub>	$F_x$ (N)	$F_{z,traction}$ (N)	$F_{z,compression}$ (N)	$M_{cox}$ (Nm)	$M_{coy,Extension}$ (Nm)	$M_{coy,flexion}$ (Nm)
Level I	650	Diagram	Diagram	Diagram	134	42	190
Level II	1000	Diagram	Diagram	Diagram	134	57	190

- (iv) dummy weight: 87.5 kg  $\pm$  2.5 kg;
- (v) impact point position in plane  $XY$  regarding the exact impact point:  $\pm 15$  mm;
- (vi) yaw angle of the dummy:  $0^\circ \pm 2^\circ$ .

The main objective of the MPS is to keep the sliding motorcyclist from hitting the barrier post or another roadside object and, at the same time, to redirect the motorcyclist into the road but very close to the barrier. To verify behaviour, some variables must be analysed. Depending on the biomechanical criteria, two severity levels, I and/or II, are established. After a test, if the system does not meet the minimum requirements for the worse level, level II, it is not considered suitable for installation on the roads. Table 1 shows maximum level for each of the mechanical indexes for both tests (vane and post).

With these limited values it is possible to analyse the influence of each parameter in the evaluable results that is the main objective of the paper.

If TS 1317-8 regulation is compared with other previous regulation, an evolution of them can be pointed.

The "Technical Regulations for Delivery of Guardrail-Post Protections" [16] describes the requirements of energy absorption that MPS have to fulfill. In this case the motorcyclist is substituted with a wooden cylinder of 35 kg weight that impact with a  $90^\circ$  angle and 60 km/h velocity; during the impact it is not allowed that the wooden cylinder reach a maximum of more than 60 g, and its time interval of over 3 ms must not be greater than 40 g at any time. This is a quite simple test but its biofidelity is very poor.

The LIER test developed by Bouquet et al. in 1998 [17] specifies two test configurations as follows.

- (i)  $30^\circ$  configuration: the motorcyclist is launched against the MPS lying down with his back on the surface and with the head in the direction of impact. It describes a trajectory that forms a  $30^\circ$  angle with the barrier with a tolerance of  $0.5^\circ$ .
- (ii) Configuration  $0^\circ$ : the motorcyclist is launched against the safety device which describes a  $30^\circ$  angle trajectory. However, in this case, the body is parallel to the barrier to be tested so that the dummy will impact with the shoulder and the head.

It must be pointed that both these regulations do not specify the impact point (centre, vane) and so the variability of the results was higher due to this factor.

For the LIER, there is an impact configuration identical to the TS 1317-8 with the same impact angle but the LIER regulation has a lower tolerance margin ( $0.5^\circ$  versus  $2^\circ$ ).

The impact speed in both cases is 60 km/h with a tolerance margin of  $\pm 5\%$ . This is similar to the TS 1317-8 but

in the TS 1317-8 tolerance margin is [ $+0$ ,  $+6\%$ ] and so the test is more restrictive and the impact more severe.

The dummy selected for performing the LIER tests was an assembly of elements from other dummies:

- (i) Hybrid II thorax, limbs, and shoulders (cheaper than Hybrid III of the TS 1317-8 test but with less biofidelity),
- (ii) a pelvis from a pedestrian kit in order to give it an articulate standing position. (used too in the TS 1317-8 test),
- (iii) Hybrid III head and neck allowing measures of acceleration, force, and moments (used too in the TS 1317-8 test),
- (iv) provided too with motorcyclist equipment (suit, glove, boots, and helmet, used too in the TS 1317-8 test).

The biomechanical limits that the LIER establishes are as follows:

- (i) resultant head acceleration 220 g (TS 1317-8 does not use this variable because it is included in the HIC variable),
- (ii) HIC 1000 (equal to TS 1317-8 level II),
- (iii) neck flexional moment 190 Nm (equal to TS 1317-8, levels I and II),
- (iv) neck extension moment 57 Nm (equal to TS 1317-8 level II),
- (v) neck  $F_x$  3300 N (equal to TS 1317-8 level II),
- (vi) neck  $F_z$  traction 3300 N (equal to TS 1317-8 level II),
- (vii) neck  $F_z$  compression 4000 N (equal to TS 1317-8 level II).

### 3. Analysis and Discussion about the Regulation

TS-1317-8 is an experimental test of the impact of a motorcyclist against MPS which will always vary as the impact parameters do. No one accident is similar to another. The regulation was developed for the most common and representative accident because it must be an objective reference to establish a minimum safety level of a new device based on repeatable, nonvariable testing.

Some factors have more influence in head accelerations and neck forces like geometry and type of helmet, so the standard defines a reference crash helmet (trade mark, model, and size). Other influential variables are impact parameters; the TS-1317-8 establishes a tolerance range for each parameter

TABLE 2: Tolerance range for each impact parameter and analysed values.

Impact parameter	Reference value	Analyzed values				Maximum value	Minimum value	Range
Velocity (km/h)	60	61.8	63.6			60	63.6 (+2%)	[+0%, +2%]
Impact height (mm)	0	-60	-30	30	60	60	-60	$\pm 60$
Impact angle ( $^{\circ}$ )	30	28	32			32	28	$\pm 2$
Weight (Kg)	87.5	85	90			90	85	$\pm 2.5$
Impact position (mm)	0	-15	15			15	-15	$\pm 15$
Yaw angle ( $^{\circ}$ )	0	-2	2			2	-2	$\pm 2$

and the real test procedure limits them but the test can be modified to reduce variation range.

Capitani and Pellari [18] evaluated the influence of approach angle and speed using a multibody dummy and demonstrated that a rise in impact velocity and/or angle increases all the measured physical values and makes injuries more serious, but no one has yet analysed whether variation in each parameter inside the range of tolerance significantly modifies the forces and accelerations.

After contacting some companies that certify these results like IDIADA and CIDAUT it has been observed that some MPS change in behaviour between a test and another; one hypothesis is that the range of tolerances significantly influences the behaviour of the system.

This is because in the test the head and the back of the dummy are bouncing and rebounding, the neck changes its angular position, and the launch system, RRS, and MPS install process all introduce imprecisions, so impact parameters can vary and a range of tolerances must be established. They can be reduced if they are too high.

This work analysed the influence of the tolerance for each parameter with the numerical model based on the finite element method (FEM) (see Figure 5). This methodology shows if each parameter significantly influences the behaviour of the system by changing the impact severity level and the potential damage.

This can represent an important weakness of the standard, because it establishes the severity level only with the results of one unrepeated test in every trajectory. The result could therefore be just a matter of luck.

#### 4. Method

The method used is based in the analysis of the influence of each impact parameter of Section 2 independently in the main injury criteria analysed in the regulation: HIC, neck forces, and condyle movement, comparing the results for the exact value and other representative values inside the tolerance range (Figure 3 and Table 2).

Two different trajectories independently specify the standard for a continuous MPS for each parameter: centred post impact and centred rail impact. We studied 28 load cases and compared them with the reference load case.

The cost of each experimental test is about 30.000€ (two impacts: post and vane, the cost of two prototypes, and the installation cost), economically impossible. Instead, we have used numerical methods with finite elements. A previously

validated model for the MPS systems [13] has a high degree of numerical-experimental correlation (error < 25%), for the head injury criterion ( $HIC_{35}$ ), resultant acceleration ( $A_{res}$ ), vertical acceleration ( $A_z$ ), vertical traction and compression forces ( $F_{z, trac}/F_{z, com}$ ), condyle movement in  $x$  direction ( $M_{cox}$ ), and crash dynamics. For the other injury criteria ( $A_y$ ,  $A_x$ ,  $F_x$ ,  $F_y$ ,  $M_{coy, extension}$ ,  $M_{coy, flexion}$ , and  $M_{coz}$ ), it has low numerical-experimental correlation, but some of those indexes are not included by the standard analysis and have low values due to the dynamic of the crash ( $A_x$ ,  $A_y$ ,  $F_y$ , and  $M_{coz}$ ), leaving only two important parameters without much correlation,  $F_x$  and  $M_{coy}$ . Results for these parameters are not included.

The finite-element software LS-DYNA and a numerical model of a Hybrid III 50th percentile dummy (version LSTC.H3.060707 BETA) did the crash test numerical simulations. The Miralbes 2013 model includes a dummy with legs positioned upright using a pelvis kit with one clavicle (at the impact side) modified using fusible screws to improve biofidelity. All the modifications, degrees of correlation, results for the numerical-experimental validation, statistical analysis of the results, helmet simulation and materials, boundary conditions, limitations, and any other aspect of the numerical simulation are deeply explored in the paper [13, Figure 5 and Table 3].

The FE model was developed with the recommended verification and validation procedures for FE simulations of the ISO TR 16250:2013 (Table 3). The developed FE model has a high numerical-experimental correlation with the injury criteria HIC,  $F_x$ ,  $F_z$ , and accelerations peak values in the first 4 ms of impact time, when showing the maximum/minimum peak values used to determine the victim's injuries.

It is necessary to highlight at this point that the regulation has an additional weakness, because the dummy used is a Hybrid III percentile designed and tested for frontal impacts inside a vehicle but adapted for this concrete application. It was not designed and correlated for lateral tests with direct impact against elements like MPS; there is therefore no evidence of this dummy's biofidelity for the analysed test in the neck and thorax zones and for the neck movement, so the injury criteria used could not be representative [11].

Therefore real tests using cadavers will be necessary for the new type of dummy. For the HIC, there is evidence of a high degree of biofidelity of the results, Aiello et al. [19], so the dummy used can predict the damage in the brain.

Other injury criteria help analyse risk and damage in other zones, such as the thorax, femur, and pelvis, but these

TABLE 3: Statistical analysis of the FEM model correlation.

	$A_x$ (g's)	$A_y$ (g's)	$A_z$ (g's)	$A_{tot}$ (g's)	$F_x$ (N)	$F_y$ (N)	$F_z$ (N)	$M_{cox}$ (Nm)	$M_{coy}$ (Nm)	$M_z$ (Nm)
Minimum peak value	-38.99*	-80.12**	-19.61**	93.35*	-790.44*	-265.65*	-5190.24**	-64.26*	-49.66*	-16.02*
Maximum peak value	47.38**	13.10**	42.64**		473.09*	1380.03**	1692.26**	64.30**	39.99*	20.66*
Minimum peak value error	49.49*	-23.98**	-1.79**		789.10*	-249.35*	-113.76**	39.86*	26.26*	-33.28*
Maximum peak value error	-126.93*	29.93*	9.13**		-99.83*	93.86*	2.19**	-62.03*	-52.88*	207.74*
Mean error	6.92**	3.20**	-4.44**	9.95**	660.91*	233.97*	-38.26**	9.15**	35.21*	-20.66*
	14.61**	24.43**	-10.41**	10.66**	139.70*	16.95**	-2.26**	14.23**	88.05*	-100.00*
	3.47**	-3.18**	5.29**	-3.41**	495.65*	-35.29**	-141.18**	16.00*	16.35*	23.47*
	109.26*	-62.79*	-126.76*	-15.47**	125.29*	-13.95**	154.84*	69.57*	119.83*	1246.88*
	6.00**	2.00**	5.60**	-3.40**	530.00*	-160.00**	-1064.00**	14.00**	17.80*	25.80*
	53.57*	13.89**	-35.00*	-9.44**	94.64*	-30.77*	76.92*	46.98*	92.71*	1842.86*
	3.50**	-18.75*	6.50**	-5.25**	925.00*	-137.50**	412.00**	12.00**	36.25*	37.50*
	51.85*	500.00*	-371.43*	-19.27**	148.00*	-47.83*	66.67*	41.67*	284.31*	288.46*
	1.50**	0.50**	3.25**	-1.75**	332.50*	0.00**	98.00**	2.75**	5.25**	14.00*
	-28.57**	13.33**	260.00*	-13.73**	139.27*	0.00**	25.00**	16.67**	53.85*	-315.79*
	2.25**	2.25**	5.75**	-3.25**	186.50*	187.50*	154.00*	37.75*	5.75**	15.30*
	-112.50*	64.29*	209.09*	-37.14*	158.72*	750.00*	63.16*	188.75*	51.00*	-750.00*
	6.33**	9.90**	5.91**	6.67**	367.78*	228.03**	545.33**	17.53**	15.71*	13.85*
	5.20**	13.20**	9.76**	2.08**	324.00*	472.00*	811.00**	20.00**	18.96*	19.84*
	14.25**	6.88**	8.00**	16.75**	525.00*	87.50**	191.00**	13.50**	14.38*	3.75**
	1.75**	2.00**	4.25**	4.13**	57.50**	50.00**	211.00**	2.25**	7.38*	6.50*
	3.94**	0.56**	1.75**	3.75**	36.50**	140.63**	212.50**	12.00**	2.63**	7.00*
	85.78*	176.50*	66.68*	109.30*	197451.40*	126695.50*	569480.97*	350.47*	355.29*	245.07*
	31.65*	444.71*	151.62*	4.32*	131945.00*	330061.25*	152634.00*	425.60*	530.96*	403.92*
	306.75*	39.98*	81.83*	353.81*	565732.81*	2761719*	72534.00*	176.64*	501.56*	61.44*
	4.25*	6.25*	18.69*	22.69*	3668.75*	5000.00*	47845.00*	6.69*	80.69*	63.50*
	17.19*	0.69*	1.69*	23.19*	1116.75*	37968.75*	52354.00*	21.69*	10.69*	75.50*
	0.68*	0.74*	0.72*	0.64*	0.83*	0.64*	0.72*	0.94*	0.83*	0.89*
	0.92*	0.63*	0.79*	1.00*	0.89*	0.82*	2.08*	0.97*	0.82*	0.99*
	0.81*	1.09*	0.88*	0.89*	0.70*	0.53*	0.71*	1.02*	0.64*	0.48*
	0.85*	0.80*	0.98*	0.87*	0.95*	0.71*	0.96*	0.87*	0.82*	0.82*
	0.95*	0.68*	1.35*	0.78*	1.09*	0.72*	0.93*	2.58*	0.80*	0.81*
	0.79**	0.19**	0.87**	0.58**	-0.01**	0.59**	0.81**	0.77*	0.46*	-0.09**
	0.96**	0.38**	0.96**	1.00**	0.53*	0.83**	0.93**	0.88**	0.69*	-0.33**
	0.47**	0.05**	0.06**	0.07**	-0.57**	-0.08**	-0.05**	0.28**	-0.07**	0.14**
	0.12**	0.02**	0.02**	0.82**	-0.24**	-0.03**	0.06**	0.03**	-0.09**	-0.14**
	0.13**	0.01**	0.00**	0.02**	0.00**	0.15**	0.02**	-0.05**	0.04**	-0.44**

\*\* High statistical correlation.

\* Low statistical correlation.

# Very low statistical correlation.



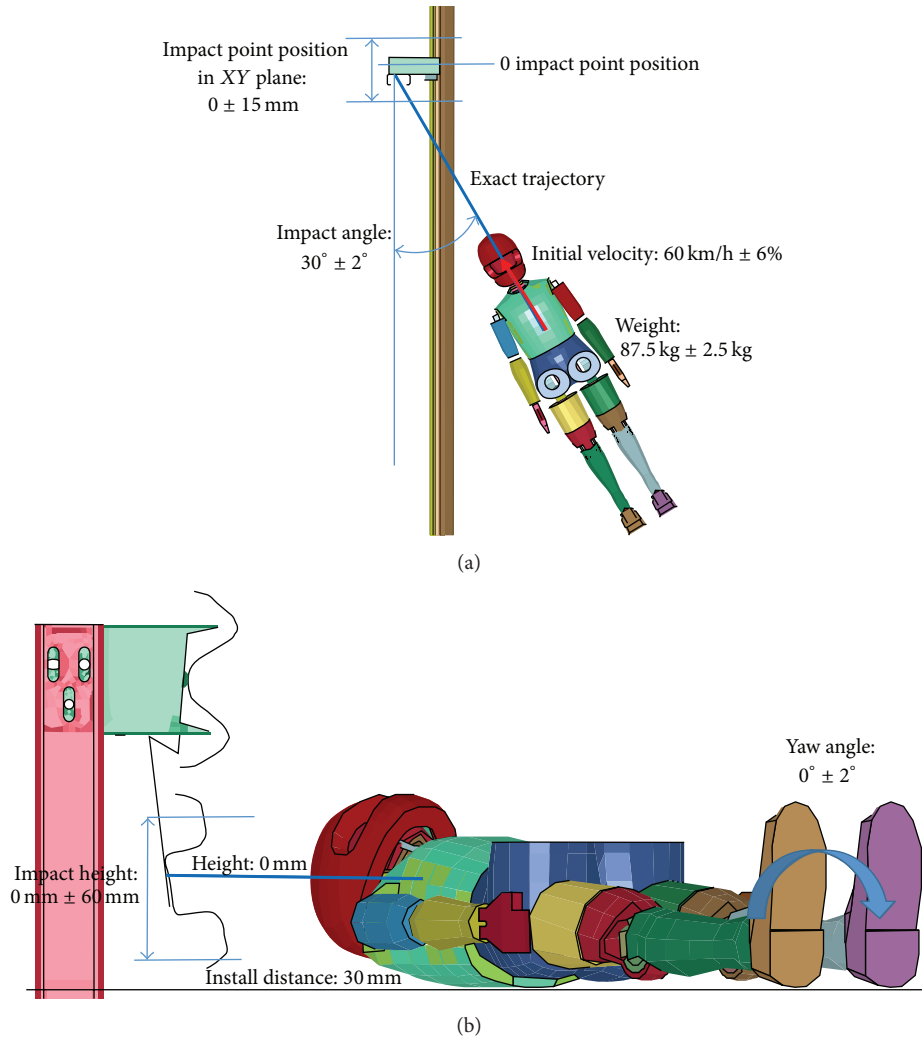

FIGURE 3: Impact parameters for the UNE-EN-135900 test.

zones are not the most representative or harmful and are usually not analysed.

The road restraint system (RRS) model has no influence over MPS behaviour [13].

## 5. Result

To evaluate the influence of tolerances in the injury criteria, it is necessary to specify admissible variation limits for each index. They have been established within  $\pm 15\%$  of the level I limit of the standard (Table 1).

The standard establishes no limit for head accelerations. We have used a limit of 200 Gs [20].

The SPM model, the BMSNA2/120b, is a homologated system developed by the Spanish “Ministerio de Fomento” and accepted after the test, but later tests demonstrated that the MPS do not pass the homologation test because traction forces higher than the maximum admissible limit appearing in the neck. The AMM test and Miralbes [13] remarked on this and are attributed to the variability of the results of the test due to the tolerances.

We used BMSNA2/120b, the most common MPS, as reference but the results for the  $F_{z, \text{trac}}$  are not significant in the analysis.

Figure 6 uses radial graphics to analyse the influence of each impact parameter in each injury criterion, the results, and any deviation of the results higher than  $\pm 15\%$  and higher than the level I limit of the regulation.

**5.1. Impact Velocity Analysis.** There are some factors that determine impact velocity deviation in the test: the intrinsic imprecision of the launch system, the dynamic of the dummy during free flight, and the friction with the floor; they determine the tolerances for impact velocity that allow a maximum admissible deviation of  $[+0\%, +6\%]$ .

Impact velocity has a negative impact in damage. A higher impact velocity implies higher kinetic energy that must be absorbed, with higher decelerations, forces, and movements in the neck (Table 4), higher injury risk.

It is observed too that the injury risk increases according to the increase of the velocity but there is not a linear or quadratic relation between the parameters, even though

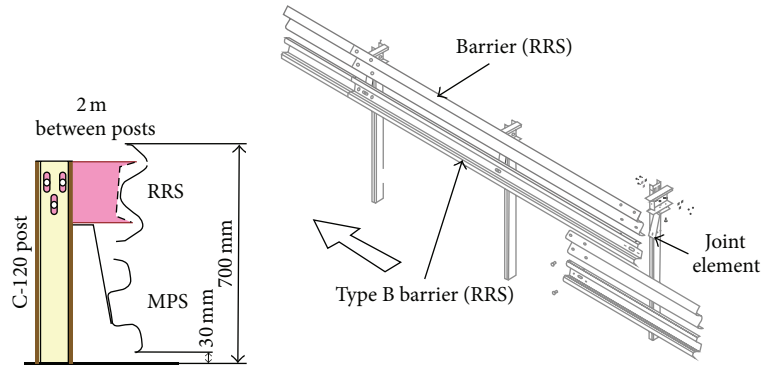

FIGURE 4: MPS systems.

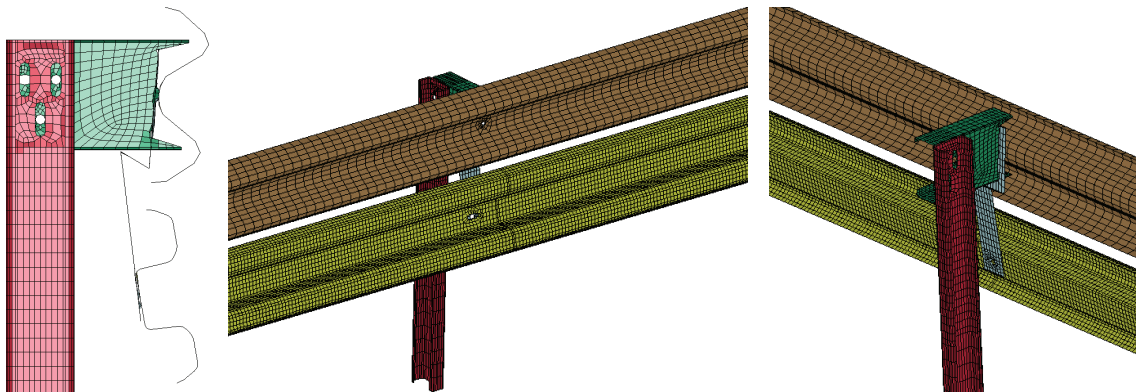

FIGURE 5: Finite elements model of the barrier with the MPS (lateral, frontal, and rear view).

the kinetic energy increases quadratically with the velocity, because an impact is quite complex and depends on the movement of the neck and helmet behaviour.

Table 4 shows a maximum deviation of 14,4% in the results for both impacts, within the maximum admissible deviations.

The MPS passes the homologation test for all tolerance ranges, except the  $F_{z, \text{trac}}$  at level I, and injuries increase with velocity, but not lineally because a 6% of increase of the velocity is associated with a 14% of increase in some injury criteria.

**5.2. Impact Angle Analysis.** There are some factors that determine this parameter: the correct alignments of MPS with RRS, the leveling of the floor, the mechanical imprecisions of the launch system, the imprecision of the dummy location in the trolley, and the dynamic of the test. Standards define a  $\pm 2^\circ$  maximum deviation. Analysing the implied factors, such deviation is difficult to reduce.

Table 4 shows results for this parameter and it is observed that the injury criteria and risk increase according to the increase of the angle because a more oblique angle requires a higher transversal kinematic energy to absorb. Table 4 has a maximum deviation of 26,6% for the  $M_{\text{cox}}$ , but for the other parameters the deviation is less than 8%. Injury risk also increases with velocity.

**5.3. Impact Height Analysis ( $z$ ).** The impact height has significant influence because it changes the impact zone and thus the geometry of the MPS, swinging distance, and joint element. Some factors determine this parameter as follows.

- (i) The installation height (Figure 4): there is usually a deviation in this parameter due to an incorrect installation, usually because the post is not sufficiently deeply installed.
- (ii) Test dynamic: the dummy is launched using a trolley that drops it far before the impact point so the dummy is launched supposedly with the back continuously in contact with the floor; the truth is that the dummy suffers continuous bounces and rebounds and neck and head movements, so the impact height, the yaw angle, the impact velocity, and all the other impact parameters change.

These factors determine the tolerances for the impact height that allows a maximum admissible deviation of  $\pm 60$  mm.

There is not a clear relation between this parameter and biomechanical results or injury risk (Table 4) because the impact point changes the geometry of the MPS (Figure 7) but the results deviate more than admissible, so the tolerances for the impact height parameter must be modified. A more careful installation guarantees a lower deviation with not

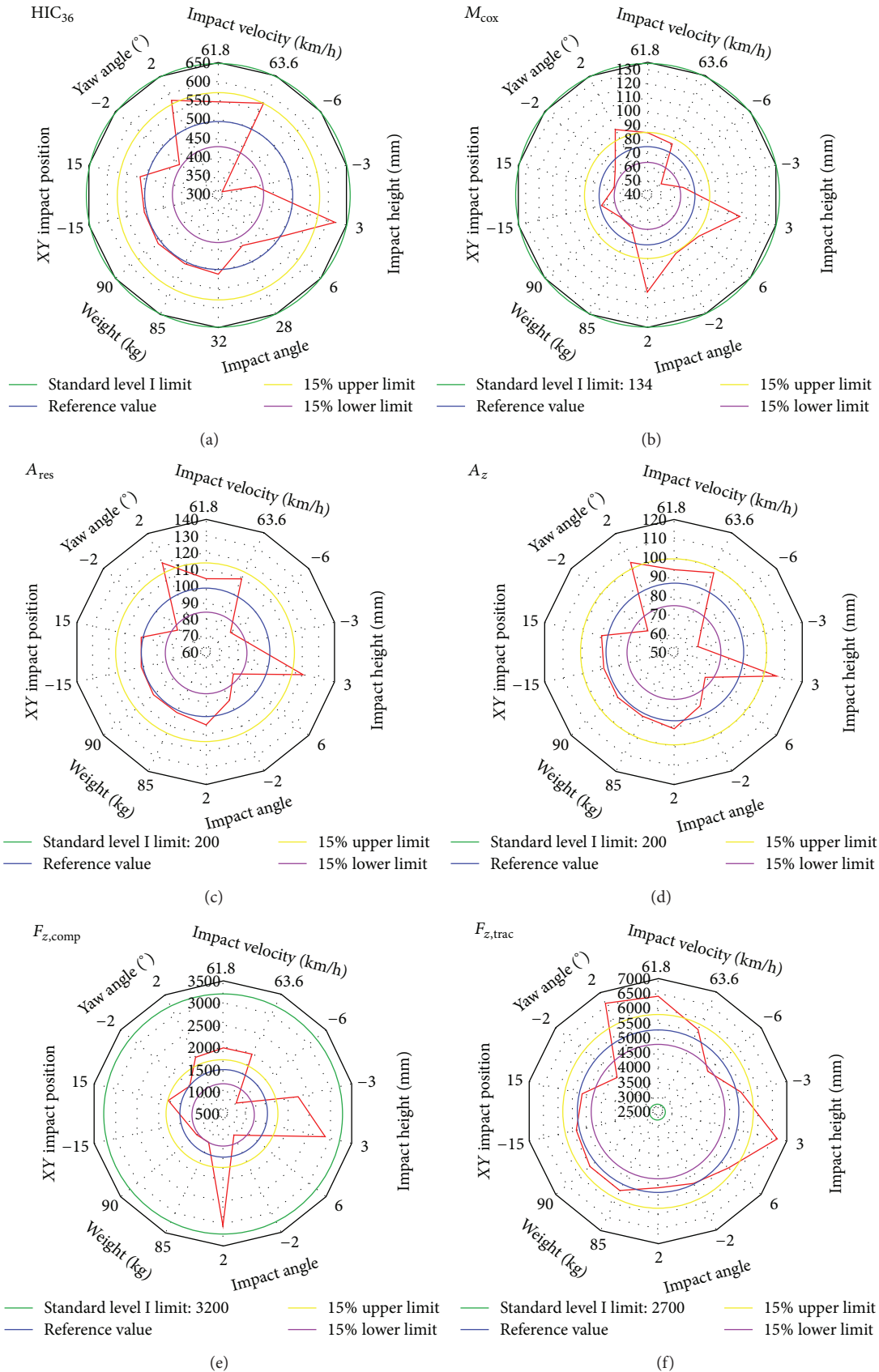

FIGURE 6: Left to right and up to down: radial graphics of the  $HIC_{36}$ ,  $M_{cox}$ ,  $A_{res}$ ,  $A_z$ ,  $F_{z,comp}$ , and  $F_{z,trac}$  versus all the impact parameters.



TABLE 4: Deviation of the biomechanical results depending on each impact parameter.

		Impact velocity analysis										Impact point analysis															
		Centred post impact					Centred vane impact					Centred post impact					Centred vane impact										
Limit value	Results	Reference	Velocity	Deviation	% deviation	Limit value	Results	Reference	Velocity	Deviation	% deviation	Limit value	Results	Reference	Impact point (mm)	Deviation	% deviation	Limit value	Results	Reference	Impact point (mm)	Deviation	% deviation				
650	HIC	498.4	548	49.6	71.9	11.1	650	HIC	498.4	500.7	510.6	2.3	12.2	0.4	1.9	15	15	0.4	1.9	0 mm	498.4	500.7	510.6	2.3	12.2	0.4	1.9
200	$A_{result}$ (g's)	99.4	104.5	109.6	5.1	10.2	200	$A_{result}$ (g's)	99.4	99.6	100.2	0.2	0.8	0.1	0.4	15	15	0.1	0.4	99.4	99.6	100.2	0.2	0.8	0.1	0.4	
200	$A_z$ (g's)	87.5	93.8	96.5	6.3	9	200	$A_z$ (g's)	87.5	88	89	0.5	1.5	0.3	0.8	15	15	0.3	0.8	87.5	88	89	0.5	1.5	0.3	0.8	
2700	$F_{z,frac}$ (N)	<b>5360</b>	<b>6430</b>	1070	220	<b>39.6</b>	2700	$F_{z,frac}$ (N)	<b>5360</b>	<b>5354.8</b>	<b>5132</b>	-5.2	-228	-0.2	-8.4	15	15	-0.2	-8.4	<b>5360</b>	<b>5354.8</b>	<b>5132</b>	-5.2	-228	-0.2	-8.4	
3200	$F_{z,comp}$ (N)	1536	1983	1997	447	461	3200	$F_{z,comp}$ (N)	1536	1346	1770	-190	234	-5.9	7.3	15	15	-5.9	7.3	1536	1346	1770	-190	234	-5.9	7.3	
134	$M_{cox}$ (Nm)	74.6	85.3	81.3	10.7	6.7	134	$M_{cox}$ (Nm)	74.6	73.7	64.6	-0.9	-10	-0.7	-7.5	15	15	-0.7	-7.5	74.6	73.7	64.6	-0.9	-10	-0.7	-7.5	
		Impact velocity analysis										Impact point analysis															
		Centred post impact					Centred vane impact					Centred post impact					Centred vane impact										
Limit value	Results	Reference	Velocity	Deviation	% deviation	Limit value	Results	Reference	Velocity	Deviation	% deviation	Limit value	Results	Reference	Impact point (mm)	Deviation	% deviation	Limit value	Results	Reference	Impact point (mm)	Deviation	% deviation				
650	HIC	487.8	543.3	556.1	68.3	8.5	650	HIC	487.8	477.33	490	-10.47	2.2	-1.6	0.3	15	15	-1.6	0.3	487.8	477.33	490	-10.47	2.2	-1.6	0.3	
200	$A_{result}$	97.9	107.5	108.3	9.6	10.4	200	$A_{result}$	97.9	97.2	98.5	-0.7	0.6	-0.4	0.3	15	15	-0.4	0.3	97.9	97.2	98.5	-0.7	0.6	-0.4	0.3	
200	$A_z$	86.7	93.3	96.3	6.6	9.6	200	$A_z$	86.7	86.2	87.1	-0.5	0.4	-0.3	0.2	15	15	-0.3	0.2	86.7	86.2	87.1	-0.5	0.4	-0.3	0.2	
2700	$F_{z,frac}$	<b>6385</b>	<b>6745</b>	<b>6563.4</b>	360	178.4	2700	$F_{z,frac}$	<b>6385</b>	<b>5296</b>	<b>6369</b>	-1089	-16	-40.3	-0.6	15	15	-40.3	-0.6	<b>6385</b>	<b>5296</b>	<b>6369</b>	-1089	-16	-40.3	-0.6	
3200	$F_{z,comp}$	1926	2021	2383.4	95	457.4	3200	$F_{z,comp}$	1926	2423	1714	497	-212	15.5	-6.6	15	15	15.5	-6.6	1926	2423	1714	497	-212	15.5	-6.6	
134	$M_{cox}$	79.5	84.7	93.34	5.2	13.84	134	$M_{cox}$	79.5	94.5	59.8	15	-19.7	11.2	-14.7	15	15	11.2	-14.7	79.5	94.5	59.8	15	-19.7	11.2	-14.7	
		Impact angle analysis										Yaw angle analysis															
		Centred post impact					Centred post impact					Centred post impact					Centred post impact										
Limit value	Results	Reference	Impact angle	Deviation	% deviation	Limit value	Results	Reference	Impact angle	Deviation	% deviation	Limit value	Results	Reference	Yaw angle	Deviation	% deviation	Limit value	Results	Reference	Yaw angle	Deviation	% deviation				
650	HIC	498.4	446.5	509.8	-51.9	11.4	650	HIC	498.4	430.7	578.6	-67.7	80.2	-10.4	12.3	2°	2°	-10.4	12.3	498.4	430.7	578.6	-67.7	80.2	-10.4	12.3	
200	$A_{result}$ (g's)	99.4	92.6	104.3	-6.8	4.9	200	$A_{result}$ (g's)	99.4	81.8	120.5	-17.6	21.1	-8.8	10.6	2°	2°	-8.8	10.6	99.4	81.8	120.5	-17.6	21.1	-8.8	10.6	
200	$A_z$ (g's)	87.5	81.2	90.7	-6.3	3.2	200	$A_z$ (g's)	87.5	67.5	102.5	-20	15	-10.0	7.5	2°	2°	-10.0	7.5	87.5	67.5	102.5	-20	15	-10.0	7.5	
2700	$F_{z,frac}$ (N)	<b>5360</b>	<b>5221</b>	<b>5100.5</b>	-139	-259.5	2700	$F_{z,frac}$ (N)	<b>5360</b>	<b>4298</b>	<b>6587.3</b>	-1062	1227.3	-39.3	45.5	2°	2°	-39.3	45.5	<b>5360</b>	<b>4298</b>	<b>6587.3</b>	-1062	1227.3	-39.3	45.5	
3200	$F_{z,comp}$ (N)	1536	1068.7	3050.7	-467.3	1514.7	3200	$F_{z,comp}$ (N)	1536	1481	1919	-55	383	-1.7	12.0	2°	2°	-1.7	12.0	1536	1481	1919	-55	383	-1.7	12.0	
134	$M_{cox}$ (Nm)	74.6	86.3	109.8	11.7	35.2	134	$M_{cox}$ (Nm)	74.6	69.5	92.9	-5.1	18.3	-3.8	13.7	2°	2°	-3.8	13.7	74.6	69.5	92.9	-5.1	18.3	-3.8	13.7	

(b) Continued.

Impact angle analysis														
Limit value	Results	Centred vane impact					Yaw angle analysis							
		Reference	Impact angle	Deviation	% deviation	Limit value	Results	Reference	Yaw angle	Deviation	% deviation			
		87.5 Kg	28°	32°	28°	32°	650	HIC	0°	-2°	2°	-2°	2°	
650	HIC	487.8	438.9	529.1	-48.9	41.3	6.4	487.8	413.2	542.6	-74.6	54.8	-11.5	8.4
200	$A_{result}$	97.9	94.1	107.6	-3.8	9.7	4.8	97.9	83.8	118.9	-14.1	21	-7.1	10.5
200	$A_z$	86.7	80.4	91.6	-6.3	4.9	2.5	86.7	65.9	101.4	-20.8	14.7	-10.4	7.4
2700	$F_{z,trace}$	<b>6385</b>	<b>5485.6</b>	<b>5437.5</b>	-899.4	-947.5	-33.3	<b>6385</b>	<b>4443</b>	<b>7422</b>	-1942	1037	<b>-71.9</b>	<b>38.4</b>
3200	$F_{z,comp}$	1926	2291.2	2519.7	365.2	593.7	11.4	1926	1972	2215	46	289	1.4	9.0
134	$M_{cox}$	79.5	83.8	88.6	4.3	9.1	3.2	79.5	69.6	95.3	-9.9	15.8	-7.4	11.8

(c)

Weight analysis																					
Limit value	Results	Centred post impact					Impact height analysis														
		Reference	Weight (kg)	Deviation	% deviation	Limit value	Results	Reference	Impact height (mm)	Deviation	% deviation										
		87.5 Kg	85	90	-2°	2°	650	HIC	0 mm	-60	-30	30	60	-60	-30	30	60				
650	HIC	498.4	501.5	502.5	3.1	4.1	0.5	498.4	315.5	403.3	617.3	481.7	-182.9	-95.1	118.9	-16.7	-28.1	-14.6	<b>18.3</b>	-2.6	
200	$A_{result}$ (g's)	99.4	100.5	100.6	1.1	1.2	0.5	99.4	78.8	85.4	120.9	81.3	-20.6	-14	21.5	-18.1	-10.3	-7.0	10.8	-9.1	
200	$A_z$ (g's)	87.5	87.8	88.2	0.3	0.7	0.1	87.5	67.5	62.76	105.4	71.2	-20	-24.74	17.9	-16.3	-10.0	-12.4	9.0	-8.2	
2700	$F_{z,trace}$ (N)	<b>5360</b>	<b>5492.3</b>	<b>5483.5</b>	132.5	123.5	4.9	<b>5360</b>	<b>4663</b>	<b>5390</b>	<b>6647.3</b>	<b>5565.4</b>	-697	30	1287.3	205.4	-25.8	-20.5	1.1	<b>47.7</b>	7.6
3200	$F_{z,comp}$ (N)	1536	1234.8	1259.3	-301.2	-276.7	-9.4	1536	881	2237	2874.3	1302.5	-655	701	1338.3	-233.5	-20.5	<b>21.9</b>	<b>41.8</b>	<b>-7.3</b>	
134	$M_{cox}$ (Nm)	74.6	65.5	65.2	-9.1	-9.4	-6.8	74.6	52.7	65.9	108.4	87.1	-21.9	-8.7	33.8	12.5	-16.3	-6.5	<b>25.2</b>	9.3	

Centred vane impact																				
Limit value	Results	Centred vane impact					Impact height analysis													
		Reference	Weight (kg)	Deviation	% deviation	Limit value	Results	Reference	Impact height (mm)	Deviation	% deviation									
		87.5 Kg	85	90	-2°	2°	650	HIC	0 mm	-6	-3	3	6	-60	-30	30	60	-60	-30	30
650	HIC	487.8	481.3	480.4	-6.5	-7.4	-1.0	487.8	318.9	372.9	568.8	390.7	-168.9	-114.9	81	-97.1	-26.0	-17.7	12.5	-14.9
200	$A_{result}$	97.9	99.9	99.7	2	1.8	1.0	97.9	81.7	73.7	120.3	76.1	-16.2	-24.2	22.4	-21.8	-8.1	-12.1	11.2	-10.9
200	$A_z$	86.7	86.6	86.5	-0.1	-0.2	-0.1	86.7	68.2	59.5	103.8	65.9	-18.5	-27.2	17.1	-20.8	-9.3	-13.6	8.6	-10.4
2700	$F_{z,trace}$	<b>6385</b>	<b>5287.4</b>	<b>5314.6</b>	-1097.6	-1070.4	-40.7	<b>6385</b>	<b>4458.3</b>	<b>5956.2</b>	<b>7221.5</b>	<b>4145.2</b>	-1926.7	-428.8	836.5	-2239.8	-71.4	-15.9	<b>31.0</b>	<b>-83.0</b>
3200	$F_{z,comp}$	1926	1401.3	1405.6	-524.7	-520.4	-16.4	1926	1929.2	1590.4	2520.9	1114.3	3.2	-335.6	594.9	-811.7	0.1	-10.5	<b>18.6</b>	-25.4
134	$M_{cox}$	79.5	62.7	61.4	-16.8	-18.1	-12.5	79.5	46.6	62.5	93.4	74.2	-32.9	-17	13.9	-5.3	-24.6	-12.7	10.4	-4.0

“In bold, cells with a result higher than the maximum allowed by the regulation” or similar.

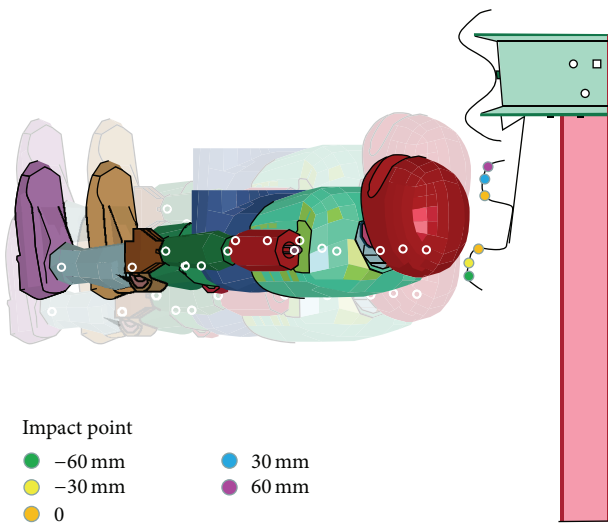

FIGURE 7: Diverse impact points for different impact heights (0  $\pm$  60 mm).

too much effort for the impact test, but not for the road installation. The latter involves other parameters like the cant and the slope of the road. Maintaining the road usually adds asphalt to it, increasing the height of the road and decreasing the installation height.

We can reduce the installation height deviation to  $\pm 5$  mm easily, also reducing height impact tolerances and making the test more repeatable. High-speed video recordings of real tests revealed an important (and nearly random) deviation in the height point of impact. Due to the geometry of the dummy and helmet when the dummy is lying on its back, a clearance appears between helmet and sliding surface (loose gravel). When the dummy is moving towards the MPS, the head is bouncing and rebounding, and the neck changes its angular position. This modifies the height of impact point by up to 45 mm.

Therefore this dummy model can reach tolerances of  $[-5 \text{ mm}, 50 \text{ mm}]$ ; these tolerances reduce the variability of negative height variances but are insufficient for positives. The test should be modified to include any type of additional element that restrains the movement of the head and the neck that should guarantee a tolerance range estimated of  $[-5 \text{ mm}, 15 \text{ mm}]$ .

It is necessary to analyse in detail the most unfavorable case of impact height (+30 mm). Figure 7 of the appendix shows the initial impact point that will determine the stiffness of the MPS. For the 0 mm impact height, the shape of the MPS has two simultaneous points equivalent to impact point in the centre with high local rigidity. On the other hand, the points of impact to  $\pm 60$  mm take place in the ends of the MPS with lower local rigidity, so the MPS will deform more easily, lowering the decelerations and forces of reaction in the head and therefore the risk of injuries.

Diminishing the impact point increases the length between it and the joint between the MPS and the RRS (or lever distance), so the same force produces higher deformation, lower decelerations, and lower injury risk (Table 4). So

the most unfavorable height of impact is +30 mm because the MPS is locally quite rigid and the lever distance is smaller. The most favourable point will be  $-60$  mm (Table 4).

**5.4. Dummy Weight Analysis ( $z$ ).** Three elements determine this parameter: the dummy, the leather motorcyclist suit, and the helmet; of these elements, only the helmet has a standard weight. The suit and dummy's weight deviates up to  $\pm 2,5$  kg (2,8%).

Table 4 shows results for this parameter and its small influence (sometimes less than 1%) except for  $F_{z, \text{comp}}$  and  $M_{\text{cox}}$ , which have high deviations. A modification of the tolerance to  $\pm 0.1$  kg is recommended and is easily achievable with a higher accuracy scale and ballast elements, making the influence of this parameter insignificant to the injury risk.

**5.5. Analysis of the Impact Point Position in XY Plane regarding the Exact Impact Point.** Four factors determine this parameter: the alignment of the centre of the post or the vane in relation to the dummy trajectory during the installation, the mechanical imprecisions of the launch system, the imprecision of the dummy location in the trolley, and the dynamic of the test. Standards define a  $\pm 15$  mm deviation. The above factors make it difficult to reduce.

Modifications of the impact point in the XY plane do not also modify the geometry in the impact point because continuous MPS have longitudinally the same geometry. Only one parameter changes: the distance from the impact point to the joint element, but the width of this element is higher than 30 mm, so the transversal local elasticity does not change significantly. This should create low deviations in the results as in Table 4.

Table 4 shows the small influence (sometimes less than 1%) of this parameter except on  $F_{z, \text{comp}}$  and  $M_{\text{cox}}$ , which have high deviations. But the implied factors make it difficult to reduce the tolerance range.

**5.6. Yaw Angle Analysis.** Some factors that determine this parameter are as follows: correct alignments of MPS with RRS, the leveling of the floor, the mechanical imprecisions of the launch system, the imprecision of the dummy location in the trolley, the leveling of the launching system, and the dynamic of the test. Standards define a  $\pm 2^\circ$  deviation and these factors make it difficult to reduce.

Table 4 shows only deviations lower than the 15% limit, admissible tolerance, so modification of this tolerance range has not been proposed.

## 6. Conclusions and Suggested Modifications of the TS-1317-8

New tolerance ranges have been proposed. Some have been reduced and others have been maintained at regulation levels. Current impact parameters and their tolerance ranges are (Table 5) as follows:

- (i) impact velocity: 60 km/h [ $+0$ ,  $+6\%$ ],
- (ii) impact height ( $z$ ):  $[-5 \text{ mm}, +45 \text{ mm}]$ ,

TABLE 5: Maximum admissible limit for each biomechanical index.

	HIC <sub>36</sub>	A <sub>result</sub> (g's)	A <sub>z</sub> (g's)	F <sub>z, trac</sub> (N)	F <sub>z, comp</sub> (N)	M <sub>cox</sub> (Nm)
Level I limit	650	200	200	2700	3200	134
Admissible deviation	±15%	±15%	±15%	±500	±15%	±15%
Reference value	498.4	99.4	87.5	5360	1536	74.6
Upper limit	595.9	129.4	117.5	5860	2016	94.7
Lower limit	400.9	69.4	57.5	4860	1056	54.5

TABLE 6: Deviation of the biomechanical results for extreme tolerance cases.

Limit value	Results	Reference	Centred post impact					
			Extreme cases		Deviation		% deviation	
			Minimum	Maximum	Minimum	Maximum	Minimum	Maximum
650	HIC	498.4	367.8	629.8	-130.6	131.4	-20.1	20.2
200	A <sub>result</sub> (g's)	99.4	90.6	105.4	-8.8	6	-4.4	3.0
200	A <sub>z</sub> (g's)	87.5	76.4	95.7	-11.1	8.2	-5.6	4.1
2700	F <sub>z, trac</sub> (N)	<b>5360</b>	<b>4393.6</b>	<b>7093</b>	-966.4	1733	-35.8	<b>64.2</b>
3200	F <sub>z, comp</sub> (N)	1536	1428	2369	-108	833	-3.4	<b>26.0</b>
134	M <sub>cox</sub> (Nm)	74.6	41.3	87.6	-33.3	13	-24.9	9.7

Limit value	Results	Reference	Centred vane impact					
			Extreme cases		Deviation		% deviation	
			Minimum	Maximum	Minimum	Maximum	Minimum	Maximum
650	HIC	487.8	387.4	<b>652.1</b>	-100.4	164.3	-15.4	<b>25.3</b>
200	A <sub>result</sub>	97.9	92.5	122.9	-5.4	25	-2.7	12.5
200	A <sub>z</sub>	86.7	78.5	94.4	-8.2	7.7	-4.1	3.9
2700	F <sub>z, trac</sub>	<b>6385</b>	<b>4588</b>	<b>5387</b>	-1797	-998	-66.6	-37.0
3200	F <sub>z, comp</sub>	1926	1334	2437	-592	511	-18.5	<b>16.0</b>
134	M <sub>cox</sub>	79.5	43.7	91.2	-35.8	11.7	-26.7	8.7

"In bold, cells with a result higher than the maximum allowed by the regulation" or similar.

- (iii) impact angle:  $30^\circ \pm 2^\circ$ ,
- (iv) dummy weight:  $87.5 \text{ kg} \pm 0.1 \text{ kg}$ ,
- (v) impact point position in XY plane relative to the exact impact point:  $\pm 15 \text{ mm}$ ,
- (vi) yaw angle of the dummy:  $0^\circ \pm 2^\circ$ .

Point 5 has discussed the way to reduce each range, but we propose further research to reduce impact height deviation to  $[-5 \text{ mm}, +15 \text{ mm}]$  developing new neck restraint system during the launch and the free flight.

The next step is the analysis of the joint influence of tolerance ranges, except impact height, which depends mainly on MPS geometry. The extreme cases have been analysed (Table 6).

The analysis of the extreme tolerance cases reflects high deviation of the results for some injury criteria (Table 7) but for accelerations deviation variance lower than 15% is acceptable. HIC has a better experimental correlation and defines the injuries that appear in the brain and has a maximum deviation of 25%.

Depending on the experimental test, the MPS had a level I or level II of protection because of an excessive range of deviation for the impact variables and HIC variance from 387

to 650. This made the test inadmissible and unrepeatable, so it had to be redesigned and the range of tolerances reduced.

Compliance with the requirements of the standard test does not guarantee that the system is safe under other conditions not exactly those of the test. The test could reject better MPS for having more unfavorable values inside the deviation range than an actually worse one. This calls into question the objectivity of the standard.

An alternative to the real test is "virtual testing." It has guaranteed repeatability and evaluates the performance of an MPS under different impact conditions economically unfeasible using real test, with intrinsic high tolerance ranges and high cost.

The FEM model used has a degree of error for the results that influences the study of tolerances; this model presents a high degree of correlation in the results for many of the injury criteria; there is an error between 2.2% and 14.0%, for the HIC, the most representative parameter. This error of the FEM model is carried to the results of the tolerances analysis, so numerical results will differ from the experimental ones by a certain percentage, but it has been supposed that this variation is always with a similar percentage, making quantitative analysis of it useful. If mistakes are assumed similar for both numerical models compared, then the results' variation would be similar to that of the experimental tests.

TABLE 7: Proposal tolerance range for the impact parameters and higher and lower harmful test parameters.

Impact parameter	Reference	Proposal tolerance range	Higher harmful case	Lower harmful case
Impact velocity (km/h)	60	[0, +6%]	63.6	60
Impact height (z) (mm)	0	[-5, 15]	0	0
Impact angle (°)	30	±2	32	28
Dummy weight	87.5	±0.1	87.6	87.4
Impact point position in plane XY (mm)	0	±15	0	0
Yaw angle of the dummy (°)	0	±2	2	-2

The developed model was validated only for the average values of the parameters of the regulation. The model has been extrapolated out of the validation range so it supposes additional error in the results.

This error has been assumed because it was economically impossible to carry out the necessary minimum of 24 experimental tests.

The experimental tests would be suitable to validate the numerical model in the tolerance range and analyse the influence of the tolerances, so then the numerical analysis would not be necessary. The economic aspect is one of the motives for using a numerical test with an assumed range of validation and low degree of error.

Another weakness of the regulation is the fact that the impact height in a real accident (like other variables) is usually different from that of regulation and depends on variables like the installation process, the cant and the slope of the road, and the maintenance process, and the dynamic of one accident makes it quite possible that the real impact point will vary from the theoretical one. Models should consider more impact points and impact heights. Angle of the neck and contact with the ground can also vary, heightening impact points. In Section 5.3, it is suggested an additional test with an impact point in the upper 1/4 length of the MPS (with high local rigidity and low lever distance) will be more representative and less harmful.

## Conflict of Interests

The author declares that there is no conflict of interests regarding the publication of this paper.

## Acknowledgments

The publication of this research paper has been possible thanks to the funding given by the Industry and Innovation Department of the Government of Aragon as well as by the European Social Funds, the Research Groups GEDiX, according to Regulation (CE) no. 1828/2006 of the 8th of December Commission.

## References

- [1] H.-L. Chang and T.-H. Yeh, "Risk factors to driver fatalities in single-vehicle crashes: comparisons between non-motorcycle drivers and motorcyclists," *Journal of Transportation Engineering*, vol. 132, no. 3, pp. 227–236, 2006.
- [2] A. Daniello and H. C. Gabler, "Fatality risk in motorcycle collisions with roadside objects in the United States," *Accident Analysis and Prevention*, vol. 43, no. 3, pp. 1167–1170, 2011.
- [3] H. Gabler, "The risk of fatality in motorcycle crashes with roadside barriers," in *Proceedings of the 20th International Technical Conference on the Enhanced Safety of Vehicles*, Lyon, France, 2007.
- [4] J. M. Holdridge, V. N. Shankar, and G. F. Ulfarsson, "The crash severity impacts of fixed roadside objects," *Journal of Safety Research*, vol. 36, no. 2, pp. 139–147, 2005.
- [5] H. H. Jama, R. H. Grzebieta, R. Friswell, and A. S. McIntosh, "Characteristics of fatal motorcycle crashes into roadside safety barriers in Australia and New Zealand," *Accident Analysis and Prevention*, vol. 43, no. 3, pp. 652–660, 2011.
- [6] A. B. Ibitoye, A. M. S. Hamouda, S. V. Wong, and R. S. Radin, "Simulation of motorcyclist's kinematics during impact with W-Beam guardrail," *Advances in Engineering Software*, vol. 37, no. 1, pp. 56–61, 2006.
- [7] H. H. Jama, R. H. Grzebieta, R. Friswell, and A. S. McIntosh, "Characteristics of fatal motorcycle crashes into roadside safety barriers in Australia and New Zealand," *Accident Analysis & Prevention*, vol. 43, no. 3, pp. 652–660, 2011.
- [8] ACEM, "MAIDS In depth investigations of accidents involving powered two wheelers," Final Report, 2004, [http://ec.europa.eu/transport/roadsafety\\_library/publications/](http://ec.europa.eu/transport/roadsafety_library/publications/).
- [9] M. R. Bambach, R. H. Grzebieta, and A. S. McIntosh, "Injury typology of fatal motorcycle collisions with roadside barriers in Australia and New Zealand," *Accident Analysis and Prevention*, vol. 49, pp. 253–260, 2012.
- [10] A. Molinero, APROSYS SP 4. Final report for the work on "Motorcyclist Accidents", 2009, [http://www.transportresearch.info/Upload/Documents/201203/20120313\\_144753\\_24930\\_Final%20SP4%20report%20AP-90-0004.pdf](http://www.transportresearch.info/Upload/Documents/201203/20120313_144753_24930_Final%20SP4%20report%20AP-90-0004.pdf).
- [11] S. Peldschus, "Report on accident scenario's for motorcycle motorcyclist-infrastructure interaction. State-of-the-art in order to identify and assess road infrastructure main features," Future research guidelines, 2005.
- [12] D. García, B. P. Magallón, S. Peldschus, E. Schuller, A. M. Gallo, and S. Bidal, "Overview on the development of a test standard for the evaluation of motorcyclists' impacts on road infrastructure elements," *International Journal of Crashworthiness*, vol. 15, no. 1, pp. 1–15, 2010.
- [13] R. Miralbes, "Design of motorcycle rider protection systems using numerical techniques," *Accident Analysis & Prevention*, vol. 59, pp. 94–108, 2013.
- [14] S. Peldschus and E. Schuller, "Simulation of motorcyclists' impacts on roadside barriers using a numerical human model," in *Proceedings of the 6th International Motorcycle Conference*, Cologne, Germany, 2006.



- [15] P. S. Schuller, E. J. Koenig, M. Gaertner, D. García, and A. Mansilla, "Technical bases for the development of a test standard for impacts of powered two-wheelers on roadside barriers," *ESV Paper Number 07-0332*.
- [16] Bundesanstalt fuer Strassenwesen BAST, "Technical Regulations for Delivery of Guardrail-Post Protections," 1993.
- [17] R. Bouquet, M. Ramet, and M. Dejammes, "Protocole d'essais de dispositifs de retenue assurant la securité des motocyclistes," Report LBSU no. 9807, LIER/INRETS, 1998.
- [18] R. Capitani and S. S. Pellari, "Analysis of the behaviour of biker protection devices for roadside barriers," *International Journal of Crashworthiness*, vol. 17, no. 5, pp. 461–478, 2012.
- [19] M. Aiello, U. Galvanetto, and L. Iannucci, "Numerical simulations of motorcycle helmet impact tests," *International Journal of Crashworthiness*, vol. 12, no. 1, pp. 1–7, 2007.
- [20] E. F. Horner, *Head and Neck Injuries in Sports*, 1994.