

1     **Construction, characterization and preclinical evaluation of MTBVAC, the first**  
2             **live-attenuated *M. tuberculosis*-based vaccine to enter clinical trials**

3  
4     Ainhoa Arbues<sup>a,b,1</sup>, Juan I. Aguilo<sup>a,b</sup>, Jesus Gonzalo-Asensio<sup>a,b,c</sup>, Dessislava Marinova<sup>a,b</sup>,  
5     Santiago Uranga<sup>a,b</sup>, Eugenia Puentes<sup>d</sup>, Conchita Fernandez<sup>d</sup>, Alberto Parra<sup>d</sup>, Pere Joan  
6     Cardona<sup>b,e</sup>, Cristina Vilaplana<sup>b,e</sup>, Vicente Ausina<sup>b,f</sup>, Ann Williams<sup>g</sup>, Simon Clark<sup>g</sup>, Wladimir  
7     Malaga<sup>h</sup>, Christophe Guilhot<sup>h</sup>, Brigitte Gicquel<sup>i</sup>, Carlos Martin<sup>a,b,c,\*</sup>

8  
9     <sup>a</sup>Grupo de Genética de Micobacterias, Dpto. Microbiología, Medicina Preventiva y Salud  
10     Pública, Universidad de Zaragoza, C/ Domingo Miral s/n, 50009 Zaragoza, Spain.

11     <sup>b</sup>CIBER Enfermedades Respiratorias, Instituto de Salud Carlos III, Madrid, Spain.

12     <sup>c</sup>Servicio de Microbiología, Hospital Universitario Miguel Servet, ISS Aragón, Paseo Isabel la  
13     Católica 1-3, 50009 Zaragoza, Spain.

14     <sup>d</sup>BIOFABRI S.L., A Selva s/n, 36410 O Porriño (Pontevedra), Spain.

15     <sup>e</sup>Fundació Institut d'Investigació en Ciències de la Salut Germans Trias i Pujol. Universitat  
16     Autònoma de Barcelona. Unitat de Tuberculosi Experimental. Crtra. de Can Ruti, Camí de  
17     les Escoles, s/n, 08916 Badalona (Barcelona), Spain.

18     <sup>f</sup>Hospital Universitari Germans Trias i Pujol. Universitat Autònoma de Barcelona.  
19     Microbiology Department. Crtra. Del Canyet, s/n, 08916, Badalona (Barcelona), Spain.

20     <sup>g</sup>Microbiological Services Division, Public Health England, Porton Down, Salisbury SP4 0JG,  
21     United Kingdom.

22     <sup>h</sup>CNRS, IPBS (Institut de Pharmacologie et de Biologie Structurale), 205 Route de Narbonne,  
23     BP 64182, 31077 Toulouse, France; Université de Toulouse, UPS, IPBS.

24     <sup>i</sup>Institut Pasteur, Mycobacterial Genetics, 25-28 Rue du Docteur Roux, 75015 Paris, France.

25  
26     \* Corresponding author: Mailing address: Dpto. Microbiología, Medicina Preventiva y Salud  
27     Pública, Facultad de Medicina, Universidad de Zaragoza, C/ Domingo Miral s/n, 50009  
28     Zaragoza, Spain. Phone: (+34) 976 76 17 59. Fax: (+34) 976 76 16 64. E-mail:  
29     [carlos@unizar.es](mailto:carlos@unizar.es).

30  
31     <sup>1</sup>Present Address : CNRS, IPBS (Institut de Pharmacologie et de Biologie Structurale), 205  
32     Route de Narbonne, BP 64182, 31077 Toulouse, France; Université de Toulouse, UPS,  
33     IPBS.

34 **ABSTRACT**

35

36 The development of a new tuberculosis vaccine is an urgent need due to the failure of the  
37 current vaccine, BCG, to protect against the respiratory form of the disease. MTBVAC is an  
38 attenuated *Mycobacterium tuberculosis* vaccine candidate genetically engineered to fulfil the  
39 Geneva consensus requirements to enter human clinical trials. We selected a *M.*  
40 *tuberculosis* clinical isolate to generate two independent deletions without antibiotic-  
41 resistance markers in the genes *phoP*, coding for a transcription factor key for the regulation  
42 of *M. tuberculosis* virulence, and *fadD26*, essential for the synthesis of the complex lipids  
43 phthiocerol dimycocerosates (DIM), one of the major mycobacterial virulence factors. The  
44 resultant strain MTBVAC exhibits safety and biodistribution profiles similar to BCG and  
45 confers superior protection in preclinical studies. These features have enabled MTBVAC to  
46 be the first live attenuated *M. tuberculosis* vaccine to enter clinical evaluation.

## 47 **1. Introduction**

48

49 The only vaccine against tuberculosis (TB) in use today, Bacille Calmette-Guerin (BCG), is a  
50 live attenuated strain of *Mycobacterium bovis* effective in reducing the rate of severe forms of  
51 TB (meningitis and miliary TB) in children, but is inconsistent in preventing spread of  
52 pulmonary TB, the most common form of the disease in adolescents and adults, which fuels  
53 the continuing epidemic [1, 2]. Developed a century ago by repeated subculture, the principal  
54 genetic basis for BCG attenuation is the loss of RD1 region, which encodes the machinery  
55 required to synthesize and export the major T-cell antigen/virulence factor ESAT-6/CFP-10  
56 [3, 4]. Subsequent worldwide distribution of BCG and repeated subculture in non-  
57 standardized conditions has led to emergence of a number of daughter BCG sub-strains,  
58 which comprise natural mutants of well-recognized virulence factors, suggesting that some  
59 sub-strains may be more attenuated and otherwise less immunogenic than others [3, 5-7].  
60 New vaccines able to prevent respiratory forms of TB will have a tremendous impact in  
61 preventing transmission and control of the disease [8-10].

62

63 We have previously described the construction of the SO2 strain by insertion of a kanamycin-  
64 resistance cassette in the *phoP* gene of a *M. tuberculosis* clinical isolate [11]. PhoP is a key  
65 transcriptional regulator, which controls approximately 2% of *M. tuberculosis* coding capacity,  
66 including the synthesis of the immunomodulatory trehalose-derived lipids, diacyl- (DAT) and  
67 polyacyl-trehaloses (PAT), and the secretion of the virulence factor ESAT-6 [12-15]. Ten  
68 years of rigorous preclinical testing of SO2 as a vaccine candidate has provided robust data  
69 for its high degree of safety and improved immunogenicity and protective efficacy compared  
70 to BCG in relevant animal models of TB, from mice to non-human primates [16-19]. Despite  
71 the promising results, the establishment of the Geneva consensus for new live mycobacterial  
72 vaccines, demanding the presence of two stable independent mutations without antibiotic-  
73 resistance markers for *M. tuberculosis*-based candidates, in addition to a safety and efficacy

74 profile at least comparable to BCG in the relevant animal models, rendered SO2 unsuitable  
75 for entry into clinical trials [20, 21].

76

77 Here we describe the construction and extensive preclinical characterization of MTBVAC, the  
78 first live-attenuated vaccine based on a *M. tuberculosis* human isolate that entered first-in-  
79 human clinical evaluation in January 2013. This vaccine is based on the prototype SO2 and  
80 is genetically engineered to fulfil the Geneva consensus requirements for progressing new  
81 live mycobacterial vaccines into Phase 1 clinical trials, requiring two non-reverting unmarked  
82 independent mutations [20]. MTBVAC contains two stable deletions in the *phoP* and *fadD26*  
83 genes without antibiotic-resistance markers. FadD26 is essential for the synthesis of  
84 phthiocerol dimycocerosates (DIM), a family of surface lipids involved in *M. tuberculosis*  
85 virulence [22, 23]. MTBVAC is safe in all preclinical studies and confers superior protection in  
86 mice compared to the reference licensed strain BCG Danish 1331 used in the clinic.

87 **2. Materials and Methods**

88

89 *2.1. MTBVAC construction and culture conditions*

90 *M. tuberculosis* Mt103, the parental strain in this study, was isolated from an  
91 immunocompetent TB patient [24]. MTBVAC vaccine candidate was constructed following  
92 standard mycobacterial genetic-engineering protocols [25-27] (for a detailed description of  
93 the process see supplementary methods).

94 Mycobacterial strains were grown at 37°C in Middlebrook 7H9 broth (Difco) supplemented  
95 with albumin, dextrose and catalase (ADC) (Difco) and 0.05% (v/v) Tween-80, or on solid  
96 Middlebrook 7H10 or 7H11 (Difco) supplemented with ADC (Difco). When required,  
97 kanamycin (20 µg/ml) was added to the media. All chemicals were purchased from Sigma-  
98 Aldrich except where indicated.

99

100 *2.2. Protein isolation and western-blot analysis*

101 *Whole-cell proteins.* Mycobacteria from early log-phase liquid cultures of Mt103 or MTBVAC  
102 were pelleted by centrifugation, washed and resuspended in phosphate-buffered saline  
103 (PBS) containing a cocktail of protease inhibitors. Cell suspensions were disrupted by  
104 sonication.

105 *Secreted proteins.* *M. tuberculosis* strains were grown in 7H9 supplemented with dextrose (2  
106 g/l) and supernatants were separated by centrifugation. Secreted proteins were precipitated  
107 by incubation with 10% (v/v) trichloroacetic acid for 30 min on ice and then centrifuged at 4°C  
108 for 30 min. Pelleted proteins were rinsed with cold acetone and resuspended in 150 mM Tris-  
109 HCl pH=8.

110 *Western blot.* Both protein preparations were sterilized using a 0.22-µm low protein-binding  
111 filter (Pall) and quantified using the RC DC protein assay (BioRad). 5 µg of protein were  
112 loaded per well and separated by SDS-PAGE. Immunodetection was carried out using  
113 primary monoclonal mouse antibodies anti-ESAT6 or anti-GroEL (Abcam), followed by

114 incubation with an anti-mouse secondary antibody and developed with a chemiluminiscent  
115 substrate (Immobilon™ western, Millipore).

116

### 117 *2.3. Complex lipids extraction and thin-layer chromatography analysis*

118 Mt103 and MTBVAC strains were grown in 16 ml of liquid medium for 10 days (exponential  
119 phase). Radiolabelling of methyl-branched fatty acids was performed by incubating the  
120 cultures with 7 µCi of <sup>14</sup>C-propionate (specific activity 55 mCi/mmol; MP Biomedicals) for 24h  
121 at 37°C with continuous agitation and mycobacterial lipids were then extracted as previously  
122 described [28]. Lipid profiles were analyzed by spotting equivalent amounts of crude extracts  
123 (resuspended in CHCl<sub>3</sub>) on silica gel G60 plates (Merck), which were then run in various  
124 solvent systems (CHCl<sub>3</sub>/CH<sub>3</sub>OH/H<sub>2</sub>O 60:16:2 (v/v) for DAT; CHCl<sub>3</sub>/CH<sub>3</sub>OH 99:1 (v/v) for PAT;  
125 and petroleum ether/diethyl ether 9:1 (v/v) for DIM). Radiolabeled lipids were visualized with  
126 a Typhoon PhosphorImager (Amersham Biosciences).

127

### 128 *2.4. Animal studies*

129 All the animals were kept under controlled conditions and observed for any sign of disease.  
130 Experimental work was conducted in agreement with European and national directives for  
131 protection of experimental animals and with approval from the competent local ethical  
132 committees.

133

#### 134 *Mouse studies*

135 For immunogenicity studies, BALB/c mice (Charles River) were mock-treated or  
136 subcutaneously inoculated with 5x10<sup>5</sup> colony forming units (CFU) of reconstituted lyophilized  
137 MTBVAC, prototype SO2 or BCG Danish 1331. At 7, 28 and 60 days post-inoculation,  
138 splenocytes were collected from 4 animals per group and stimulated overnight with purified  
139 protein derivative (PPD) [16]. Intracellular staining of IFN $\gamma$  was performed using BD  
140 Cytotfix/Cytoperm Fixation/Permeabilization kit following manufacturer instructions.

141 For biodistribution studies, groups of male or female BALB/c mice (Charles River) received  
142 an intradermal injection of  $5 \times 10^5$  CFU of reconstituted lyophilized MTBVAC or BCG Danish  
143 1331. At weeks 1, 2, 4, 8, 16 and 24 post-inoculation, 4 mice per group were randomly  
144 selected and sacrificed for enumeration of viable bacteria in inguinal and axillary lymph  
145 nodes, spleen, liver, lungs, kidneys, testis, ovaries and brain. Urine and stool samples were  
146 collected at each time point. Organs were homogenized and viable bacteria were counted by  
147 plating onto selective 7H11-ADC supplemented with antibiotics to avoid contamination.

148 For protection studies, groups of 8 C57BL/6 mice (Janvier) were mock-treated or  
149 subcutaneously vaccinated with  $5 \times 10^5$  CFU of reconstituted lyophilized MTBVAC or BCG  
150 Danish 1331. 8 weeks post-vaccination, mice were intranasally challenged with 100 CFU of  
151 virulent *M. tuberculosis* H37Rv. 4 weeks later, mice were humanely sacrificed and CFU  
152 quantified in lungs and spleen.

153 For safety studies, groups of 12 CB-17/lcr Ico SCID mice (Charles River) received a single  
154 subcutaneous administration of  $2.5 \times 10^7$  CFU (equivalent to 50 times the dose recommended  
155 for BCG in humans,  $5 \times 10^5$ ) of vaccine strains MTBVAC, BCG Pasteur or BCG Danish 1331;  
156 a group was inoculated with  $10^5$  CFU of parental *M. tuberculosis* Mt103 as the virulence  
157 control. The endpoint of the experiment was defined as survival up to 13 weeks post-  
158 inoculation and then animals were humanely euthanized and bacterial load in lungs and  
159 spleen was quantified.

160

#### 161 *Guinea pig studies*

162 For protection studies, groups of 8 Dunkin-Hartley guinea pigs (Harlan) were mock-treated or  
163 subcutaneously vaccinated in the nape of the neck with  $5 \times 10^3$ ,  $5 \times 10^4$  and  $5 \times 10^5$  CFU of  
164 reconstituted lyophilized MTBVAC, or  $5 \times 10^4$  CFU of SO2 or BCG Danish 1331. 12 weeks  
165 post-vaccination, animals were subjected to an aerosol challenge of 10-50 CFU per lung of  
166 *M. tuberculosis* H37Rv (NCTC 7416) [29], using a Henderson apparatus [30]. Bacterial  
167 burden in lungs and spleen at 4 weeks post-challenge was quantified. The severity of the

168 microscopic lesions in lungs and spleen was also evaluated by a subjective histopathology  
169 scoring matrix [29].

170 For shedding and excretion experiments, groups of 10 Dunkin-Hartley guinea pigs (5 males  
171 and 5 females) (Harlan), were intradermally vaccinated with  $5 \times 10^5$  CFU of reconstituted  
172 lyophilized MTBVAC or BCG Danish 1331. Animals were observed over a period of 7 weeks  
173 post-vaccination during which samples (injection site swab, urine and stool) were collected at  
174 the selected time points and plated for the detection of possible vaccine shedding or  
175 excretion. Injection site swabs were collected at 0, 3, 7, 14, 21, 28, 35, 42 and 49 days post-  
176 inoculation. In addition, swabs of the vaccine site were collected immediately on observation  
177 of a site 'opening' event. Urine and stool samples were collected at 2, 7, 21 and 49 days  
178 post-inoculation.

179 For safety studies, groups of 8 Dunkin-Hartley guinea pigs (Harlan) were subcutaneously  
180 vaccinated with  $2.5 \times 10^7$  CFU (equivalent to 50 times the dose recommended for BCG in  
181 humans,  $5 \times 10^5$ ) of reconstituted lyophilized MTBVAC or BCG Danish 1331. Animals were  
182 observed daily over a period of 42 days post-administration and body weights of all animals  
183 were recorded weekly. At the end of the experiment, animals were euthanized and examined  
184 for any signs of TB lesions in lungs, spleen, liver and lymph nodes. Any potential lesion was  
185 recovered and submitted for culture and/or fixed and submitted for histological assessment.



### 186 **3. Results**

187

#### 188 *3.1. From SO<sub>2</sub> to MTBVAC: generation of two unmarked deletions in *phoP* and *fadD26** 189 *genes to fulfil the Geneva consensus*

190 Considering that attenuation by two non-reverting independent mutations without antibiotic-  
191 resistance markers is required to fulfil the Geneva consensus criteria, we sought to construct  
192 an SO<sub>2</sub>-based vaccine that accomplished these criteria for progressing this vaccine  
193 candidate into clinical evaluation [20]. We followed a stepwise approach to genetically  
194 engineer two stable deletions in *phoP* and *fadD26* genes in the SO<sub>2</sub> strain, with subsequent  
195 elimination of antibiotic-resistance markers, generating a novel vaccine candidate that was  
196 named MTBVAC (Fig. 1A). No significant differences in growth behaviour were observed  
197 between MTBVAC and SO<sub>2</sub> in axenic culture (Fig. S3).

198 To confirm the biochemical phenotype of MTBVAC, the lipid content of the cell wall envelope  
199 was analysed by thin-layer chromatography. This analysis confirmed that, due to *fadD26*  
200 deletion, the outermost layer of MTBVAC is devoid of DIM [22] (Fig. 1B), and that *phoP*  
201 inactivation renders MTBVAC unable to synthesize trehalose-derived lipids DAT and PAT  
202 [12] (Fig. 1C). In addition to these characteristic lipid deficiencies, the deletion of *phoP* in  
203 MTBVAC reduces the amount of intracellular ESAT-6 and prevents the secretion of this  
204 major virulence factor [14] (Fig. 1D).

205 Once the *in vitro* phenotype provided by the *phoP* and *fadD26* deletions was corroborated,  
206 MTBVAC was subjected to an extensive preclinical characterization to support its progress to  
207 clinical evaluation.

208

#### 209 *3.2. MTBVAC has vaccine properties comparable to SO<sub>2</sub>*

210 To corroborate that the phenotypic equivalence of MTBVAC and SO<sub>2</sub> translates to functional  
211 comparability, bridging studies for vaccine efficacy in guinea pigs and immunogenicity in  
212 mice were conducted.

213 First, mouse immunogenicity studies, using the clinical dose and route of administration,  
214 showed comparable results for MTBVAC and SO2 as measured by the percentage of splenic  
215 IFN $\gamma$ -producing CD4<sup>+</sup> cells, following stimulation with *M. tuberculosis* PPD, at different time  
216 points post-vaccination (Fig. S4).

217 Second, in the guinea-pig short-term protection experiment, MTBVAC conferred statistically  
218 equivalent protection compared to SO2 both in lungs (Fig. 2A) and spleen (Fig. 2B). Similar  
219 protection was provided by all the tested doses of MTBVAC. A comparable protective  
220 efficacy was obtained with BCG (data not shown), as previously described for SO2 [16].

221

### 222 3.3. MTBVAC is as safe as the licensed vaccine BCG Danish 1331

223 To support entry into clinical trials in Europe, a battery of preclinical studies of MTBVAC  
224 freeze-dried preparation, produced in compliance with Good Manufacturing Practices (GMP),  
225 was conducted in mice and guinea pigs, meeting Regulatory requirements in Spain (country  
226 of GMP manufacture) and in Switzerland (country of Phase 1 trial) in accordance with the  
227 European Pharmacopoeia monograph [31] and the WHO Recommendations to Assure the  
228 Quality, Safety and Efficacy of BCG freeze-dried vaccines for human use [32]. As BCG  
229 Danish 1331 is the only licensed TB vaccine in Europe, it was used as the reference  
230 comparator in the preclinical characterization of MTBVAC freeze-dried product.

231 MTBVAC showed a comparable safety profile to BCG Danish 1331 in the survival  
232 experiment using immunocompromised SCID mice inoculated with 50 times the  
233 recommended human dose for BCG (Table 1). All the SCID mice inoculated with the vaccine  
234 strains survived to the end of the experiment. Equivalent bacterial loads both in lungs (Fig.  
235 3A) and spleen (Fig. 3B) were observed for MTBVAC and BCG Danish 1331. In contrast,  
236 mice in the Mt103 group died by week six post-inoculation and a significantly higher bacterial  
237 burden was observed. In the case of the guinea pig study, none of the animals inoculated  
238 with 50 times the BCG dose recommended for humans died or showed signs of TB in-life or  
239 at autopsy (table 1).

240 Vaccine biodistribution in mice was mainly in a localization restricted to lymphoid organs,  
241 especially lymph nodes where a peak of colonies was observed between two and four weeks  
242 post-vaccination, followed by progressive clearance thereafter (Fig. 4). In addition, MTBVAC  
243 and BCG Danish 1331 could not be detected in urine and stool (table 1). In guinea pigs,  
244 viable MTBVAC or BCG were uniquely found in the site of vaccination only immediately after  
245 administration. In the case of BCG, some “opening” events in the site of vaccination were  
246 observed (table 1).

247

#### 248 *3.4. MTBVAC induces improved protection in mice*

249 Having established the comparable safety and biodistribution profile of MTBVAC and BCG  
250 Danish 1331 clinical lots, we conducted a preclinical protection experiment in mice to  
251 compare the efficacy of the two vaccines (table 1). Following a two-month vaccination by the  
252 clinical route and dose of administration, we compared the efficacy of MTBVAC and BCG  
253 Danish 1331 at one month post-challenge with virulent *M. tuberculosis* H37Rv (the reference  
254 laboratory strain) by the natural respiratory route of infection (Fig. 5). Even though both  
255 vaccines conferred significant protection compared to saline controls, a significantly higher  
256 reduction in bacterial burden was observed in MTBVAC group compared to BCG, both in  
257 lungs (Fig. 5A) and spleen (Fig 5B).

#### 258 4. Discussion

259

260 One of the main limitations presented with BCG is the large variability in protective efficacy  
261 afforded in clinic ranging from 0% to 80% [1, 2]. Thus, a better vaccine that can induce  
262 superior protection over BCG and which could last into adolescence and adulthood against  
263 pulmonary disease would have a tremendous impact on TB control programs [10]. MTBVAC  
264 is the first *M. tuberculosis*-based vaccine candidate to fulfil the Geneva consensus  
265 requirements for progressing new live tuberculosis vaccines to clinical trials [20]. Two  
266 unmarked deletions have been engineered in the genes *phoP* and *fadD26* to render the final  
267 vaccine construct phenotypically comparable to the vaccine prototype SO2 (Fig. 1).

268

269 MTBVAC is a derivative of a clinical isolate of *M. tuberculosis*, a classical approach to human  
270 vaccinology. Most of the whole cell live vaccines used in human immunization schedules,  
271 except for small pox, TB and rotavirus infections, are based on the attenuated pathogen from  
272 human origin [33]. MTBVAC is a derivative of a clinical isolate of *M. tuberculosis*, a classical  
273 approach to human vaccinology. The scientific rationale behind an *M. tuberculosis*-based  
274 vaccine that could replace BCG is that the latter is derived from the bovine pathogen *M.*  
275 *bovis*, an animal adapted close relative of *M. tuberculosis* which lost a series of genes in its  
276 genome in the process of its co-evolution with the immune system of its natural host. In  
277 addition, when compared to *M. tuberculosis* clinical isolates, more than one hundred genes  
278 are absent in BCG genome [3, 34]. These *M. tuberculosis*-restricted genes must be  
279 important in the successful interaction with the human immune system. Therefore, a vaccine  
280 based on a human pathogen should be more effective at inducing more specific protective  
281 immunity against TB in the clinic. To demonstrate this rationale it is imperative to go to  
282 human efficacy trials, provided that the current animal models for TB are exhausted.  
283 Remarkably, all the current TB vaccine strategies under clinical evaluation are based on  
284 BCG [35, 36]. Consequently, the use of a vaccine based on the human pathogen as  
285 MTBVAC is a novel strategy.

286

287 Results obtained in immunogenicity (Fig. S4) and protective efficacy (Fig. 2) bridging  
288 experiments provide evidence that MTBVAC is functionally comparable to its prototype SO2  
289 and, therefore, data generated in preclinical studies with SO2 were accepted by the Swiss  
290 Regulatory Authorities as valid to support MTBVAC Phase 1 clinical evaluation. SO2 proved  
291 to be safe in guinea pigs and was more attenuated than BCG Pasteur in severe combined  
292 immunodeficiency (SCID) mice [16, 18]. In addition, SO2 conferred better protection than  
293 BCG Danish 1331 in a high-dose challenge long-term protection model in guinea pigs [16,  
294 29]. SO2 also showed improved reduction of lung bacillary burden in rhesus macaques when  
295 compared to BCG [19]. Finally, immunogenicity data in mice showed that SO2 was able to  
296 induce a higher differentiation of antigen-specific CD4<sup>+</sup> T cells into central memory T cells,  
297 which correlated with longer protective efficacy in this model [37]. This latter result is  
298 especially important because some authors hypothesize that this inconsistent efficacy  
299 conferred by BCG may concern insufficient induction of long-lived memory T-cell responses  
300 [38].

301

302

## 303 **5. Conclusions**

304

305 Data shown provide evidence that MTBVAC is functionally and phenotypically comparable to  
306 its prototype SO2. The results of these studies fulfil the first and second Geneva consensus  
307 safety requirements for entry into clinical trials of live attenuated *M. tuberculosis* vaccines  
308 [20, 21]. The absence of front-line lipids, lack of ESAT-6 secretion and down-expression of  
309 the PhoP regulon, essential for virulence and pathogenesis of *M. tuberculosis*, may explain  
310 the satisfactory safety profile of MTBVAC.

311

312 Altogether, the improved protection levels against TB disease achieved by prototype SO2  
313 and MTBVAC in mice, guinea pigs and non-human primates and the rigorous preclinical

314 safety and biodistribution data presented in this work have satisfied the Regulatory  
315 Authorities and enabled MTBVAC to be the first *M. tuberculosis* vaccine candidate to enter  
316 human clinical evaluation, positioning MTBVAC as a reliable vaccine for human use with  
317 potential to replace BCG.

318

319

320 **Competing interests:** AA, JG, BG and CM are co-inventors on a composition of matter  
321 patent “tuberculosis vaccine” filled by the University of Zaragoza. AP, CF and EP are  
322 employees of Biofabri, the exclusive licensee for MTBVAC. There are no other conflicts of  
323 interest.

324

325

### 326 **Acknowledgements**

327 This work was supported by grant BIO2008-01561 and BIO2011-23555 from Spanish  
328 Ministry of Economy and Competitiveness and European FP7 grant NEWTBVAC 241745.  
329 Ainhoa Arbués was supported by fellowship BES-2006-11950 from Spanish Ministry of  
330 Science and Innovation. Jesus Gonzalo-Asensio was supported by Juan de la Cierva  
331 Programme (reference JCI-2009-03799) from Spanish Ministry of Science and Innovation.  
332 Cristina Vilaplana was supported by the programme CIBER Enfermedades Respiratorias  
333 from Spanish Ministry of Science and Innovation.

334 Authors would like to acknowledge the use of the Scientific and Technical Services at CIBA  
335 (Instituto Aragonés de Ciencias de la Salud-SAI, Universidad de Zaragoza, Spain) and the  
336 support of the staff in the Biological Investigations Group at PHE (Porton Down, UK). The  
337 authors also gratefully acknowledge TBVI Preclinical & Clinical Development Teams for their  
338 expert advice and support.

339 **References**

340

341 [1] WHO. Module 5: Tuberculosis. The immunological basis for immunization series: World Health  
342 Organization; 2011.

343 [2] Fine PE. Variation in protection by BCG: implications of and for heterologous immunity. *Lancet*.  
344 1995;346:1339-45.

345 [3] Brosch R, Gordon SV, Garnier T, Eiglmeier K, Frigui W, Valenti P, et al. Genome plasticity of BCG  
346 and impact on vaccine efficacy. *Proc Natl Acad Sci U S A*. 2007;104:5596-601.

347 [4] Pym AS, Brodin P, Brosch R, Huerre M, Cole ST. Loss of RD1 contributed to the attenuation of the  
348 live tuberculosis vaccines *Mycobacterium bovis* BCG and *Mycobacterium microti*. *Molecular*  
349 *microbiology*. 2002;46:709-17.

350 [5] Leung AS, Tran V, Wu Z, Yu X, Alexander DC, Gao GF, et al. Novel genome polymorphisms in BCG  
351 vaccine strains and impact on efficacy. *BMC Genomics*. 2008;9:413.

352 [6] Liu J, Tran V, Leung AS, Alexander DC, Zhu B. BCG vaccines: their mechanisms of attenuation and  
353 impact on safety and protective efficacy. *Hum Vaccin*. 2009;5:70-8.

354 [7] Behr MA, Small PM. Has BCG attenuated to impotence? *Nature*. 1997;389:133-4.

355 [8] Tseng CL, Oxlade O, Menzies D, Aspler A, Schwartzman K. Cost-effectiveness of novel vaccines for  
356 tuberculosis control: a decision analysis study. *BMC Public Health*. 2011;11:55.

357 [9] Young D, Dye C. The development and impact of tuberculosis vaccines. *Cell*. 2006;124:683-7.

358 [10] Abu-Raddad LJ, Sabatelli L, Achterberg JT, Sugimoto JD, Longini IM, Jr., Dye C, et al.  
359 Epidemiological benefits of more-effective tuberculosis vaccines, drugs, and diagnostics. *Proc Natl*  
360 *Acad Sci U S A*. 2009;106:13980-5.

361 [11] Perez E, Samper S, Bordas Y, Guilhot C, Gicquel B, Martin C. An essential role for phoP in  
362 *Mycobacterium tuberculosis* virulence. *Molecular microbiology*. 2001;41:179-87.

363 [12] Gonzalo Asensio J, Maia C, Ferrer NL, Barilone N, Laval F, Soto CY, et al. The virulence-associated  
364 two-component PhoP-PhoR system controls the biosynthesis of polyketide-derived lipids in  
365 *Mycobacterium tuberculosis*. *The Journal of biological chemistry*. 2006;281:1313-6.

366 [13] Gonzalo-Asensio J, Mostowy S, Harders-Westerveen J, Huygen K, Hernandez-Pando R, Thole J, et  
367 al. PhoP: a missing piece in the intricate puzzle of *Mycobacterium tuberculosis* virulence. *PLoS one*.  
368 2008;3:e3496.

369 [14] Frigui W, Bottai D, Majlessi L, Monot M, Josselin E, Brodin P, et al. Control of *M. tuberculosis*  
370 ESAT-6 secretion and specific T cell recognition by PhoP. *PLoS pathogens*. 2008;4:e33.

371 [15] Walters SB, Dubnau E, Kolesnikova I, Laval F, Daffe M, Smith I. The *Mycobacterium tuberculosis*  
372 PhoPR two-component system regulates genes essential for virulence and complex lipid biosynthesis.  
373 Molecular microbiology. 2006;60:312-30.

374 [16] Martin C, Williams A, Hernandez-Pando R, Cardona PJ, Gormley E, Bordat Y, et al. The live  
375 *Mycobacterium tuberculosis* *phoP* mutant strain is more attenuated than BCG and confers protective  
376 immunity against tuberculosis in mice and guinea pigs. Vaccine. 2006;24:3408-19.

377 [17] Aguilar D, Infante E, Martin C, Gormley E, Gicquel B, Hernandez Pando R. Immunological  
378 responses and protective immunity against tuberculosis conferred by vaccination of Balb/C mice with  
379 the attenuated *Mycobacterium tuberculosis* (*phoP*) SO2 strain. Clinical and experimental  
380 immunology. 2007;147:330-8.

381 [18] Cardona PJ, Asensio JG, Arbues A, Otal I, Lafoz C, Gil O, et al. Extended safety studies of the  
382 attenuated live tuberculosis vaccine SO2 based on *phoP* mutant. Vaccine. 2009;27:2499-505.

383 [19] Verreck FA, Vervenne RA, Kondova I, van Kralingen KW, Remarque EJ, Braskamp G, et al.  
384 MVA.85A boosting of BCG and an attenuated, *phoP* deficient *M. tuberculosis* vaccine both show  
385 protective efficacy against tuberculosis in rhesus macaques. PloS one. 2009;4:e5264.

386 [20] Kamath AT, Fruth U, Brennan MJ, Dobbelaer R, Hubrechts P, Ho MM, et al. New live  
387 mycobacterial vaccines: the Geneva consensus on essential steps towards clinical development.  
388 Vaccine. 2005;23:3753-61.

389 [21] Walker KB, Brennan MJ, Ho MM, Eskola J, Thiry G, Sadoff J, et al. The second Geneva Consensus:  
390 Recommendations for novel live TB vaccines. Vaccine. 2010;28:2259-70.

391 [22] Camacho LR, Ensergueix D, Perez E, Gicquel B, Guilhot C. Identification of a virulence gene  
392 cluster of *Mycobacterium tuberculosis* by signature-tagged transposon mutagenesis. Molecular  
393 microbiology. 1999;34:257-67.

394 [23] Cox JS, Chen B, McNeil M, Jacobs WR, Jr. Complex lipid determines tissue-specific replication of  
395 *Mycobacterium tuberculosis* in mice. Nature. 1999;402:79-83.

396 [24] Jackson M, Raynaud C, Laneelle MA, Guilhot C, Laurent-Winter C, Ensergueix D, et al.  
397 Inactivation of the antigen 85C gene profoundly affects the mycolate content and alters the  
398 permeability of the *Mycobacterium tuberculosis* cell envelope. Molecular microbiology.  
399 1999;31:1573-87.

400 [25] Malaga W, Perez E, Guilhot C. Production of unmarked mutations in mycobacteria using site-  
401 specific recombination. FEMS microbiology letters. 2003;219:261-8.

402 [26] Jackson M, Camacho LR, Gicquel B, Guilhot C. *Mycobacterium tuberculosis* protocols. In: Parish T,  
403 Stocker NG, editors. Gene replacement and transposon delivery using the negative selection marker  
404 *sacB*. Totowa: Humana Press; 2001. p. 59-75.



405 [27] Pelicic V, Jackson M, Reyrat JM, Jacobs WR, Jr., Gicquel B, Guilhot C. Efficient allelic exchange  
406 and transposon mutagenesis in *Mycobacterium tuberculosis*. Proceedings of the National Academy of  
407 Sciences of the United States of America. 1997;94:10955-60.

408 [28] Constant P, Perez E, Malaga W, Laneelle MA, Saurel O, Daffe M, et al. Role of the pks15/1 gene  
409 in the biosynthesis of phenolglycolipids in the *Mycobacterium tuberculosis* complex. Evidence that all  
410 strains synthesize glycosylated p-hydroxybenzoic methyl esters and that strains devoid of  
411 phenolglycolipids harbor a frameshift mutation in the pks15/1 gene. J Biol Chem. 2002;277:38148-  
412 58.

413 [29] Williams A, Hatch GJ, Clark SO, Gooch KE, Hatch KA, Hall GA, et al. Evaluation of vaccines in the  
414 EU TB Vaccine Cluster using a guinea pig aerosol infection model of tuberculosis. Tuberculosis  
415 (Edinb). 2005;85:29-38.

416 [30] Williams A, Davies A, Marsh PD, Chambers MA, Hewinson RG. Comparison of the protective  
417 efficacy of bacille calmette-Guerin vaccination against aerosol challenge with *Mycobacterium*  
418 *tuberculosis* and *Mycobacterium bovis*. Clinical infectious diseases : an official publication of the  
419 Infectious Diseases Society of America. 2000;30 Suppl 3:S299-301.

420 [31] Commission EP. Freeze-dried BCG vaccine. European Pharmacopoeia, 6th edn Strasbourg:  
421 Council of Europe; 2008.

422 [32] Donikian R, Gheorghiu M, Jablokova TB. Requirements for dried BCG vaccine. WHO Tech Rep  
423 Ser. 1987;745:60-92.

424 [33] Mahmoud A. The future of vaccine discovery and development. Vaccines: A biography: Springer  
425 New York; 2010. p. 375-85.

426 [34] Brosch R, Gordon SV, Marmiesse M, Brodin P, Buchrieser C, Eiglmeier K, et al. A new  
427 evolutionary scenario for the *Mycobacterium tuberculosis* complex. Proc Natl Acad Sci U S A.  
428 2002;99:3684-9.

429 [35] Grode L, Ganoza CA, Brohm C, Weiner J, 3rd, Eisele B, Kaufmann SH. Safety and immunogenicity  
430 of the recombinant BCG vaccine VPM1002 in a phase 1 open-label randomized clinical trial. Vaccine.  
431 2013;31:1340-8.

432 [36] Tameris MD, Hatherill M, Landry BS, Scriba TJ, Snowden MA, Lockhart S, et al. Safety and efficacy  
433 of MVA85A, a new tuberculosis vaccine, in infants previously vaccinated with BCG: a randomised,  
434 placebo-controlled phase 2b trial. Lancet. 2013.

435 [37] Nambiar JK, Pinto R, Aguilo JI, Takatsu K, Martin C, Britton WJ, et al. Protective immunity  
436 afforded by attenuated, PhoP-deficient *Mycobacterium tuberculosis* is associated with sustained  
437 generation of CD4(+) T-cell memory. Eur J Immunol. 2012;42:385-92.

438 [38] Orme IM. The Achilles heel of BCG. Tuberculosis (Edinb). 2010;90:329-32.

439

440 **Figure legends**

441

442 **Figure 1. From SO2 to MTBVAC: step-by-step construction (A) and biochemical**  
443 **characterization of MTBVAC (B-D).** (A) Deletions in *fadD26* and *phoP* genes were  
444 genetically engineered in SO2 strain. The final strain MTBVAC is a DIM-deficient *phoP*  
445 mutant which provides better assurance of genetic stability and has no antibiotic-resistance  
446 markers, fulfilling the Geneva consensus requirements. *phoP* and *fadD26* genes are  
447 represented as grey arrows, white rectangles illustrate antibiotic-resistance markers and  
448 black arrow-heads depicts *res* sites. Vertical discontinuous lines indicate the position of  
449 restriction sites used for strain construction and horizontal discontinuous lines depict DNA  
450 regions that are not to scale. (B-C) Thin-layer chromatography analysis showing that  
451 MTBVAC is devoid of cell-wall lipids DIM (B) and DAT/PAT (C), as direct consequence of  
452 *fadD26* and *phoP* deletions, respectively. Compounds of interest are indicated by arrow-  
453 heads. (D) The absence of ESAT-6 secretion, characteristic of *M. tuberculosis phoP*  
454 mutants, was tested by Western blot.

455

456 **Figure 2. Bridging efficacy studies of MTBVAC and SO2 in Guinea Pigs.** Guinea pigs  
457 received a subcutaneous administration of the indicated doses of MTBVAC (white, grey and  
458 black diamonds) or SO2 (black circles), or not vaccinated (white squares), followed by an  
459 aerosol challenge with virulent H37Rv. At 4 weeks post-challenge, bacterial burden was  
460 assessed in lungs (A) and spleen (B). Comparable CFU reduction was observed with SO2  
461 and the three tested doses of MTBVAC. Data are expressed as Mean  $\pm$  SEM and compared  
462 by non-parametric Mann-Whitney test. \*\*\*,  $P < 0.001$ .

463

464 **Figure 3. MTBVAC safety in SCID mice.** SCID mice received a single subcutaneous  
465 administration of MTBVAC (black), BCG Danish 1331 (dark grey) or BCG Pasteur (light grey)  
466 equivalent to 50 times the dose recommended for BCG in humans. A group inoculated with  
467 one single dose of virulent Mt103 was used as control (white). CFU in lungs (A) and spleen

468 **(B)** were determined at the endpoint of the experiment (13 weeks), except for Mt103-infected  
469 animals which died by week 6. All the animals inoculated with the vaccine strains survived  
470 until the end of the experiment and presented comparable bacterial burden. Data are  
471 expressed as Mean  $\pm$  SEM and compared using unpaired Student's *t* test. \*\*\*,  $P < 0.001$ .

472

473 **Figure 4. MTBVAC biodistribution profile.** BALB/c mice were intradermally inoculated with  
474 MTBVAC (black diamonds) or BCG Danish 1331 (white circles) and bacterial load in lymph  
475 nodes was determined. A similar clearance profile was obtained for both strains. Data are  
476 expressed as Mean  $\pm$  SEM and compared using unpaired Student's *t* test. \*,  $P < 0.05$ ; \*\*,  $P <$   
477 0.01.

478

479 **Figure 5. Protective efficacy of MTBVAC in mice.** C57BL/6 mice received a subcutaneous  
480 administration of MTBVAC (black diamonds) or BCG Danish 1331 (white circles), or were not  
481 vaccinated (white squares), followed by an intranasal challenge with virulent H37Rv. At 4  
482 weeks post-challenge, bacterial burden was assessed in lungs **(A)** and spleen **(B)**.  
483 Significant CFU reduction was observed in MTBVAC vaccinated animals compared to BCG.  
484 Data are expressed as Mean  $\pm$  SEM and compared using unpaired Student's *t* test. \*,  $P <$   
485 0.05; \*\*,  $P < 0.01$ ; \*\*\*,  $P < 0.001$ .

486

487 **Supplementary figure 1. Verification of *fadD26* deletion and subsequent elimination of**  
488 **the antibiotic-resistance marker. (A, C)** Schematic representation of *fadD26* genomic  
489 region in Mt103 **(A, C)**, SO2 $\Delta$ *fadD26::hyg* **(A)** and SO2 $\Delta$ *fadD26* **(C)**. Location of specific  
490 primers is represented above by arrow-heads and approximated expected sizes for the PCR  
491 products are indicated below. **(B, D)** PCR analysis of the strains using the primer  
492 combinations indicated in left panels (A, C).

493

494 **Supplementary figure 2. Verification of *phoP* deletion and subsequent elimination of**  
495 **the antibiotic-resistance marker. (A, C)** Schematic representation of *phoP* genomic region

496 in Mt103 (**A, C**), SO2 $\Delta$ fadD26 $\Delta$ phoP::hyg (**A**) and MTBVAC (**C**). Location of specific primers  
497 is represented above by arrow-heads and approximated expected sizes for the PCR  
498 products are indicated below. (**B, D**) PCR analysis of the strains using the primer  
499 combinations indicated in left panels (A, C).

500

501 **Supplementary figure 3. *In vitro* growth characterization of MTBVAC.** (**A**) Growth  
502 kinetics of Mt103 (squares), SO2 (circles) and MTBVAC (diamonds) was studied in 7H9  
503 liquid medium by measuring the optical density at 600 nm (OD<sub>600nm</sub>) (filled symbols) and CFU  
504 counts (open symbols). (**B**) Colony morphology of the strains on solid 7H10 medium. No  
505 major differences in the growth rate of the three strains were observed in liquid broth, while  
506 colonies were smaller for both vaccine candidates on solid medium.

507

508 **Supplementary figure 4. Bridging immunogenicity study of MTBVAC and SO2.** BALB/c  
509 mice were inoculated with MTBVAC (black), SO2 (dark grey) or BCG Danish 1331 (light  
510 grey), or not vaccinated (white), and immunogenicity was measured as the percentage of  
511 IFN $\gamma$ <sup>+</sup> CD4<sup>+</sup> splenocytes. MTBVAC and SO2 induce equivalent T-cell responses at all the  
512 studied post-inoculation time-points. Data are expressed as Mean  $\pm$  SEM.

## 513 **Supplementary methods**

514

### 515 *1. Construction of plasmids*

516 *E. coli* strains, used for cloning processes, were grown at 37°C in LB broth or agar plates.  
517 Media were supplemented with ampicillin (100 µg/ml), gentamicin (Gm) (15 µg/ml),  
518 kanamycin (Km) (20 µg/ml) or hygromycin (Hyg) (50 µg/ml), when necessary. The same  
519 strategy was used for the construction of the plasmids for *fadD26* (pAZ5) and *phoP* (pAZ18)  
520 inactivation (table S1). DNA fragments containing the *fadD26* or *phoP* genes were amplified  
521 from *M. tuberculosis* H37Rv genomic DNA using primers *fadD26F* and *fadD26R* or *phoPF*  
522 and *phoPR* [12] (table S1), respectively, and cloned in pGEM-T Easy (Promega). An *EcoRV*-  
523 *BamHI* fragment from pWM27 [25], containing a *res-Ωhyg-res* cassette, was inserted  
524 between either *BamHI* and *EcoRV* sites in *fadD26* (1,511-bp deletion) or *EcoRV* and *BclI* in  
525 *phoP* (94-bp deletion). The fragments containing the deleted *fadD26* or *phoP* genes, and  
526 their flanking regions, were then released by digestion with *XhoI* and subsequently inserted  
527 in pJQ200-*xylE* [26] (table S1), a mycobacterial suicide plasmid containing the counter-  
528 selectable marker *sacB* and the reporter gene *xylE*.

529 A resolvase expression plasmid carrying a Km-resistance cassette, pAZ20 (table S1), was  
530 constructed by inserting the *BsaBI-SphI* fragment from plasmid pPR23 [27] containing the  
531 *sacB* gene and a Gm-resistance cassette, between *SphI* and *SfoI* sites in pCG124 [25].

532

### 533 *2 Construction of MTBVAC vaccine candidate*

534 Except where indicated, mycobacterial strains were grown at 37°C in Middlebrook 7H9 broth  
535 (Difco) supplemented with ADC (Difco) and 0.05% Tween-80, or on solid Middlebrook 7H10  
536 (Difco) supplemented with OADC (ADC plus oleic acid) (Difco). When required, Km, Hyg (20  
537 µg/ml), Gm (10 µg/ml) or 2% (w/v) sucrose (Suc) were added to the media.

538 SO2 strain was electrotransformed with pAZ5 (table S1) and allelic exchange events were  
539 selected in two steps. Transformants were selected on Hyg-containing plates and single

540 colonies were assayed for Suc sensitivity. In the second step, two Hyg<sup>R</sup> Suc<sup>S</sup> colonies were  
541 propagated in liquid medium to allow a second recombination event to occur, and serial  
542 dilutions were plated on Suc-containing plates to select bacteria that had lost the *sacB* gene.  
543 To discard false-positives due to mutations in *sacB* gene, a XylE activity assay (by spreading  
544 a catechol solution) was performed. Hyg<sup>R</sup> Suc<sup>R</sup> clones were tested by PCR using various  
545 combinations of primers located either in the *fadD26* deleted region (*fadD26I1*, *fadD26I2*;  
546 table 1) or hybridizing in the *res* site (*res1*, *res2*; table S1) [25] and outside the *fadD26*-  
547 flanking regions cloned in pAZ5 (*fadD26up*, *fadD26down*; table S1 & Fig. S1A). One clone  
548 giving the pattern corresponding to allelic exchange was retained to continue the  
549 construction and named SO2Δ*fadD26::hyg* (Fig 1A & Fig. S1B). Then, to eliminate the Hyg-  
550 resistance marker, pWM19 [25] (table S1) was introduced in SO2Δ*fadD26::hyg* strain and  
551 transformants were selected at 30°C on Gm-containing plates. Two transformants were  
552 grown until saturation in liquid broth at 30°C to allow resolvase expression, and serial  
553 dilutions were plated on Suc-supplemented plates and incubated at 39°C forcing loss of  
554 pWM19. Several clones were tested for Hyg and Gm sensitivity and by PCR using primers  
555 *fadD26F* and *fadD26R* (table S1 & Fig S1C). Sequencing of the PCR product obtained from  
556 the selected clone SO2Δ*fadD26* confirmed the presence of one copy of *res* site as “scar” of  
557 the resolution process (Fig 1A & Fig. S1D).

558 Next step was the replacement of the Km-resistance cassette inserted in *phoP* gene in SO2  
559 strain by a deletion containing a *res*-flanked cassette. SO2Δ*fadD26* was electrotransformed  
560 with pAZ18 (table S1) and allelic exchange events were selected as described above to  
561 obtain the strain SO2Δ*fadD26ΔphoP::hyg* (Fig. 1A) and PCR analysis was performed using  
562 various combinations of specific primers (*res1*, *res2*, *phoPF*, *phoPR*; table S1 & Fig S2A-B)  
563 to confirm homologous recombination. Finally, plasmid pAZ20 (table S1) was introduced in  
564 SO2Δ*fadD26ΔphoP::hyg* to generate the *phoP* unmarked mutant. Transformants were  
565 selected on Km-containing plates, grown until saturation in liquid medium and plated on Suc-  
566 supplemented plates. Clones obtained were tested by PCR using primers *phoRF* and *phoPR*

567 (table S1 & Fig. S2C) and one clone giving the appropriate PCR product was selected and  
568 named MTBVAC (Fig. 1A & Fig. S2D).

569  
570  
571

**Table 1. Summary of the preclinical studies conducted with final MTBVAC product to support entry into clinical trials**

Study	Description	Animal species	Duration (weeks)	Laboratory	Results
<b>Safety 50 human doses</b>	Survival; CFU in lungs and spleen	SCID mice	13	Germans Trias I Pujol	Survival & CFU recovered equivalent to BCG
	Survival; histopathology	Guinea pigs	6	Biofabri	Survival & absence of TB lesions
<b>Biodistribution, Excretion &amp; Shedding</b>	CFU in lungs, liver, kidneys, spleen, local lymph nodes, brain and gonads	BALB/c mice	22-24	University of Zaragoza	Biodistribution equivalent to BCG
	Excretion in urine and stool				Absence of excretion
	Excretion in urine and stool & Shedding at vaccination site	Guinea pigs	7	PHE	Absence of excretion
<b>Protection</b>	CFU in lungs and spleen	C57BL/6 mice	4 post-vaccination	University of Zaragoza	Protection superior to BCG

572



573 **Table S1. Bacterial strains, plasmids and primers used in this study**

<b>Mycobacterial strains</b>	<b>Description</b>	<b>Reference</b>
Mt103	Parental <i>M. tuberculosis</i> clinical isolate	[24]
SO2	<i>phoP</i> insertion mutant in Mt103 (Km <sup>R</sup> )	[11]
MTBVAC	Double unmarked <i>phoP</i> and <i>fadD26</i> deletion mutant in Mt103 (constructed from SO2)	This work
BCG Pasteur	Laboratory reference BCG strain	Our laboratory collection
BCG Danish 1331	Only licensed BCG vaccine in Europe	Our laboratory collection
<b>Plasmids</b>	<b>Description</b>	<b>Reference</b>
pJQ200- <i>xyIE</i>	Mycobacterial suicide plasmid carrying the counterselectable marker <i>sacB</i> and the reporter gene <i>xyIE</i> ( <i>gm</i> <sup>R</sup> )	[26]
pWM27	Plasmid harboring the <i>res-Ωhyg</i> <sup>R</sup> - <i>res</i> cassette ( <i>hyg</i> <sup>R</sup> )	[25]
pAZ5	pJQ200- <i>xyIE</i> derivative containing a deleted copy of <i>M. tuberculosis fadD26</i> gene ( <i>hyg</i> <sup>R</sup> , <i>gm</i> <sup>R</sup> )	This work
pAZ18	pJQ200- <i>xyIE</i> derivative containing a deleted copy of <i>M. tuberculosis phoP</i> gene ( <i>hyg</i> <sup>R</sup> , <i>gm</i> <sup>R</sup> )	This work
pWM19	Mycobacterial thermo-sensitive plasmid for resolvase $\gamma\delta$ expression, harboring the counterselectable marker <i>sacB</i> ( <i>hyg</i> <sup>R</sup> , <i>gm</i> <sup>R</sup> )	[25]
pCG124	Mycobacterial plasmid for resolvase $\gamma\delta$ expression ( <i>km</i> <sup>R</sup> )	[25]
pPR23	Mycobacterial thermo-sensitive plasmid carrying the counterselectable marker <i>sacB</i> ( <i>hyg</i> <sup>R</sup> , <i>gm</i> <sup>R</sup> )	[27]
pAZ20	Mycobacterial plasmid for resolvase $\gamma\delta$ expression, harboring the counterselectable marker <i>sacB</i> ( <i>km</i> <sup>R</sup> , <i>gm</i> <sup>R</sup> )	This work
<b>Primers</b>	<b>Nucleotide sequence</b>	<b>Reference</b>
<i>fadD26F</i>	5'-CTCGAGTTCTCTATCCGTGTATTC-3'	This work
<i>fadD26R</i>	5'-CTCGAGGTTGGTCTTGACAG-3'	This work
<i>phoPF</i>	5'-AATCTAGATCAAGCATCAGCCGAGGTAC-3'	[12]
<i>phoPR</i>	5'-AATCTAGAGATCACCCGAACGTAGAACC-3'	[12]
<i>fadD26I1</i>	5'-CACGAATGTCATTGCCAATG-3'	This work
<i>fadD26I2</i>	5'-GCTTGAGCATGACCTCTTCG-3'	This work
<i>fadD26up</i>	5'-CAACGCAAGACGACATGG-3'	This work
<i>fadD26down</i>	5'-GCACCGTCTTGATGAAGC-3'	This work
<i>res1</i>	5'-CTAGAGCAACCGTCCGAAATATTATAA-3'	[25]
<i>res2</i>	5'-GATCTCATAAAAATGTATCCTAAATCAAATATC-3'	[25]
<i>phoRF</i>	5'- AATCTAGAGGGCAAGGGCAACAAGGAAC-3'	This work

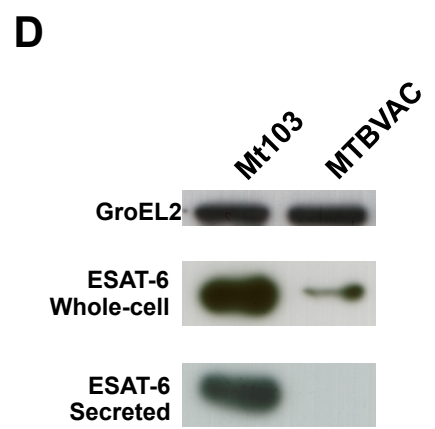
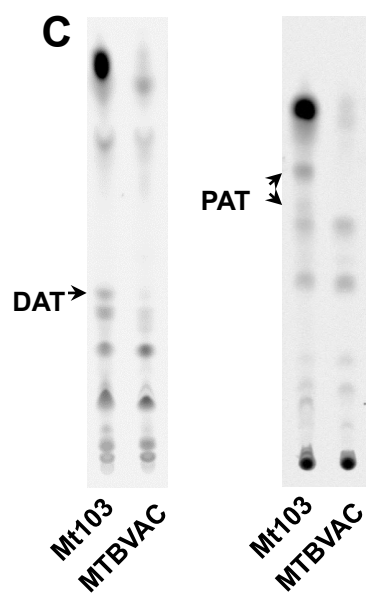
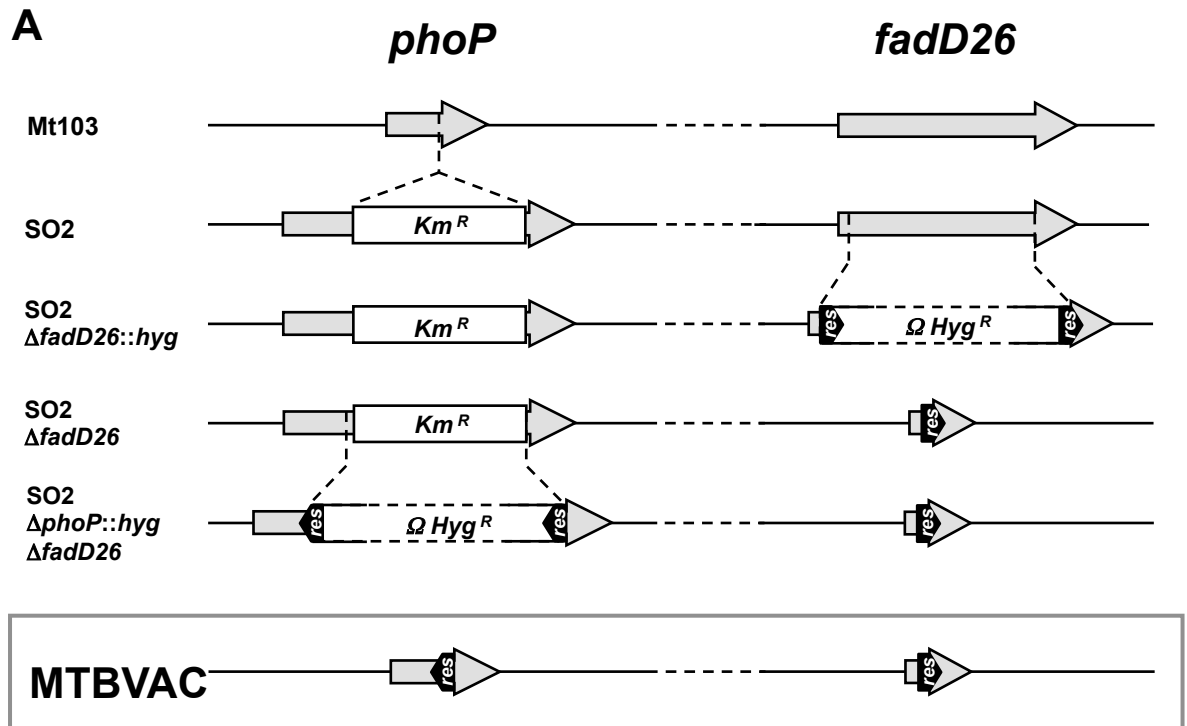

Figure 1

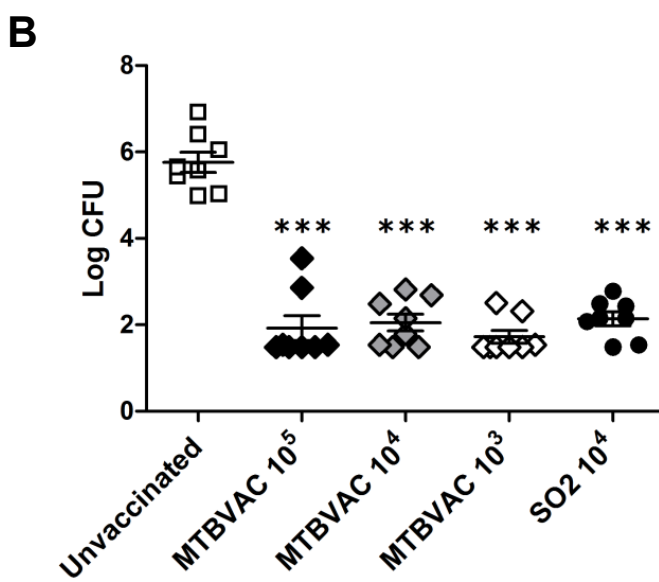
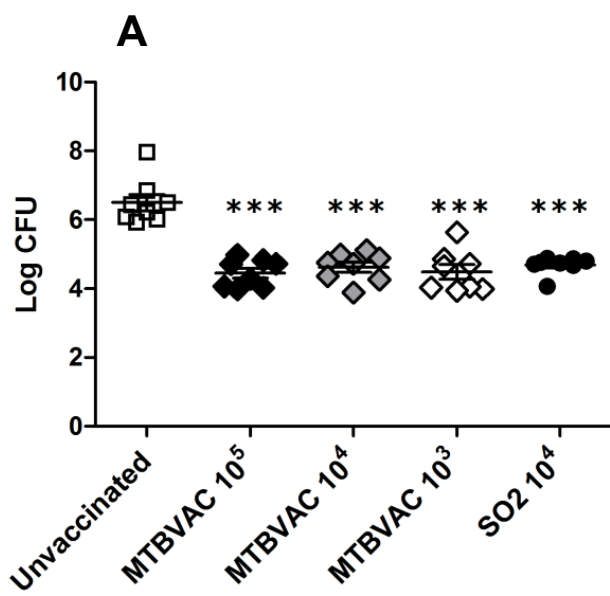
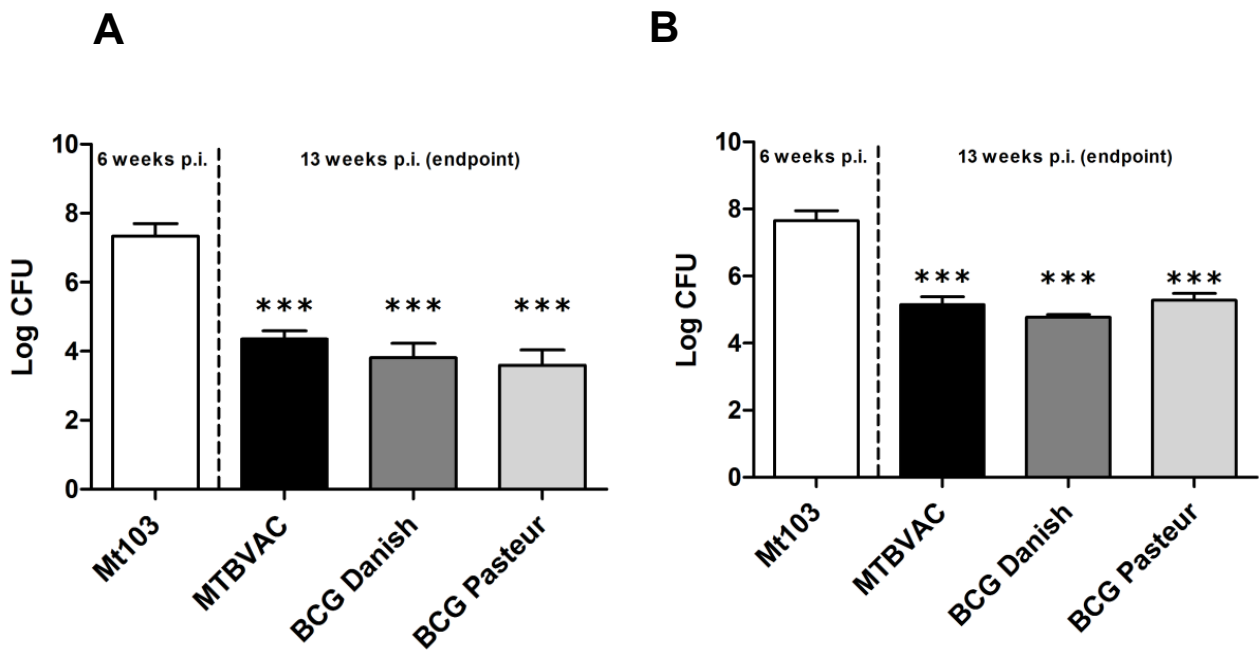

Figure 2



**Figure 3**

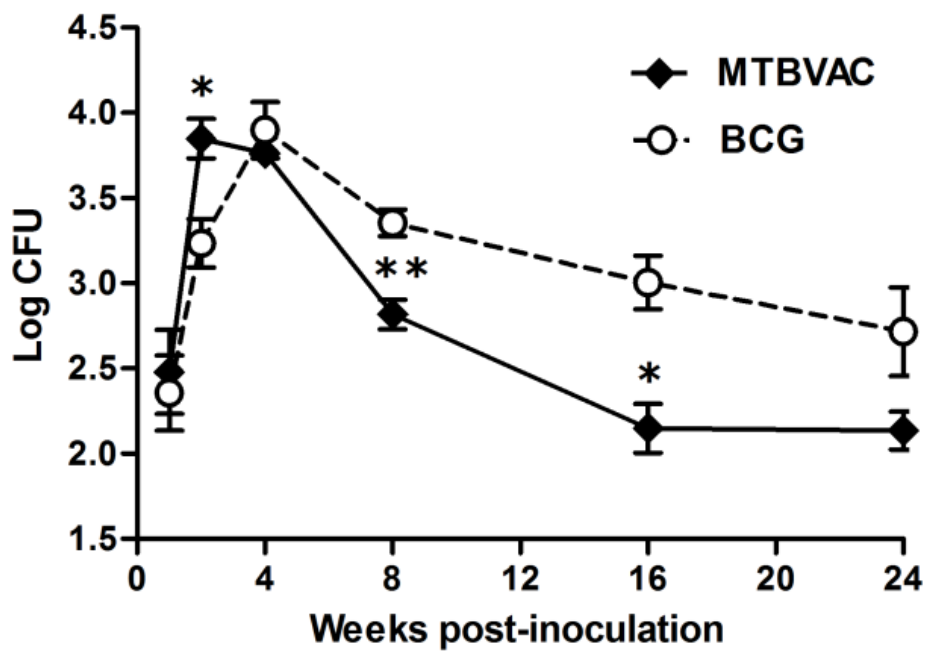

Figure 4

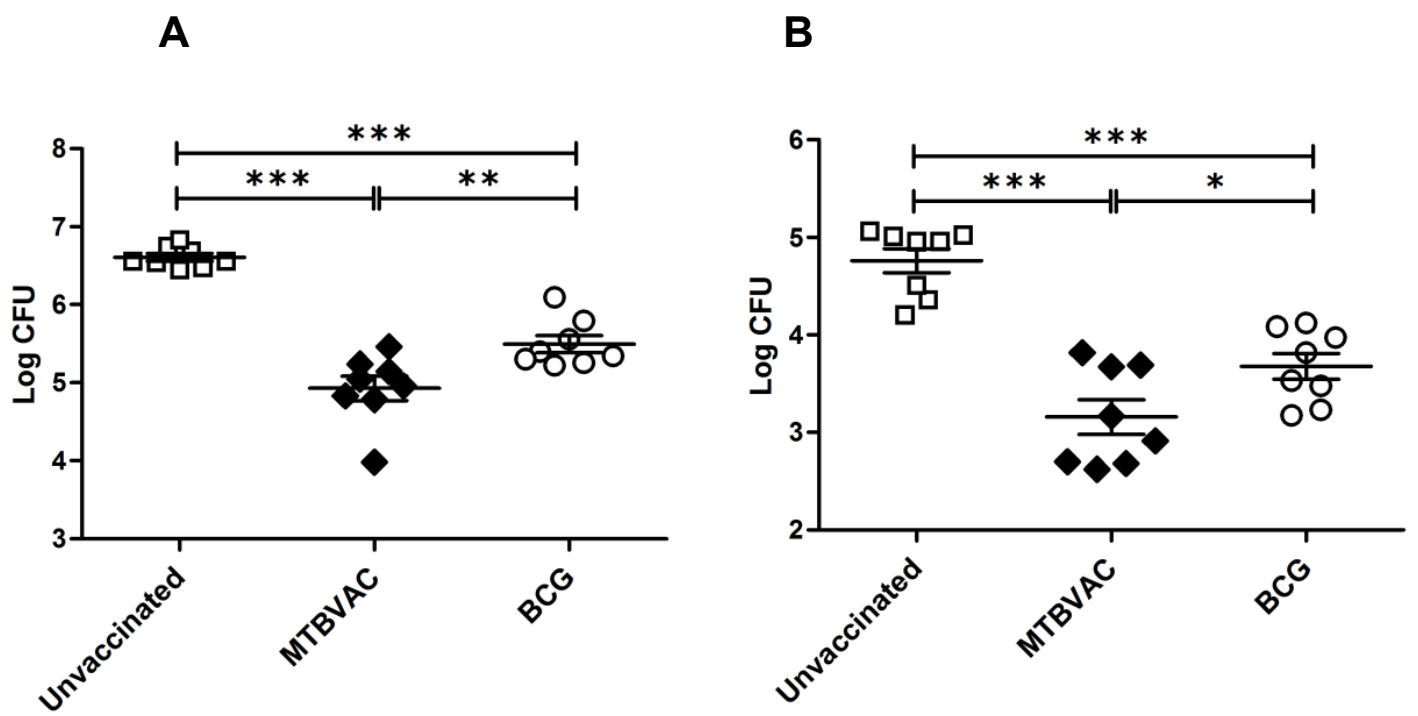

Figure 5

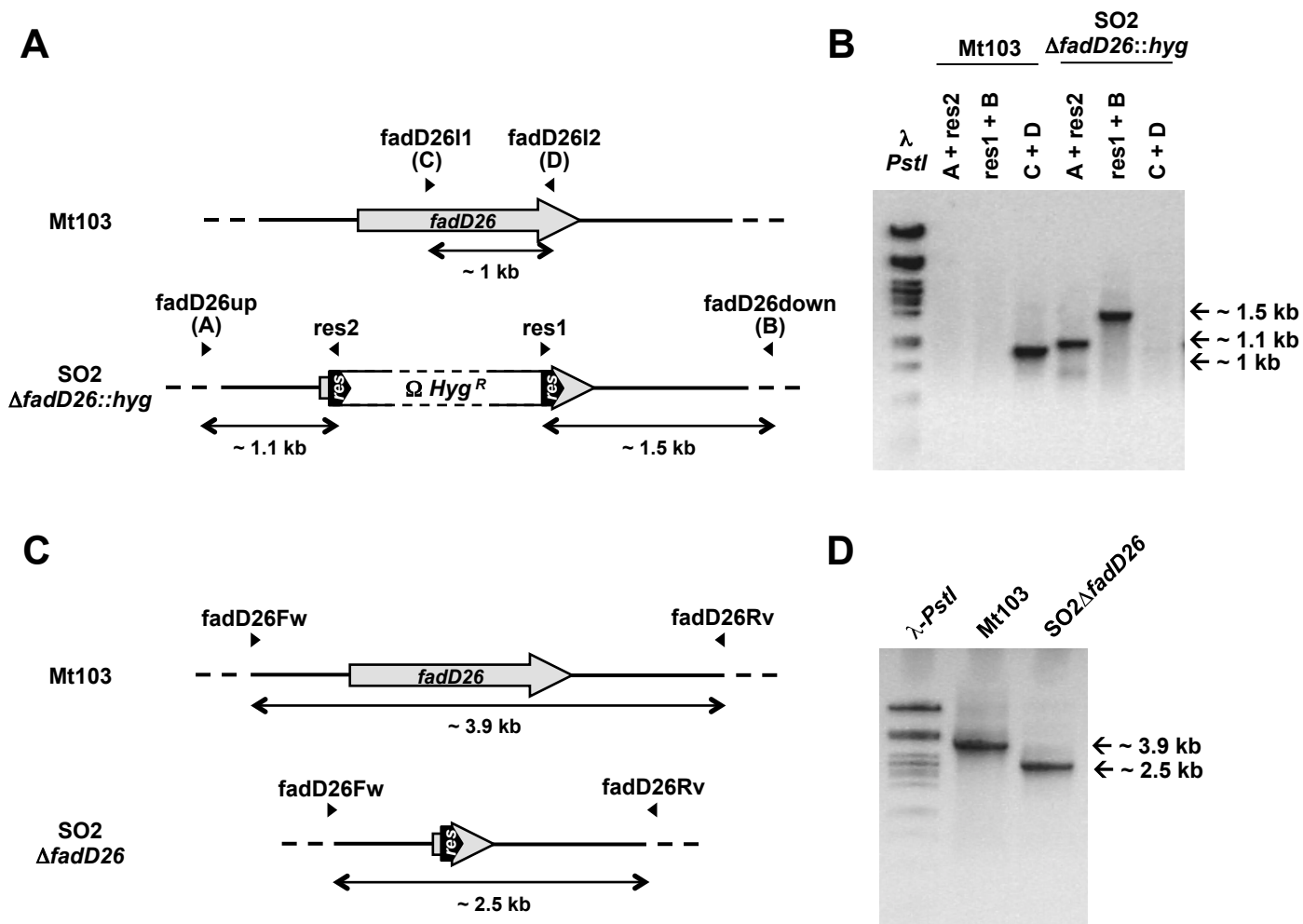

Figure s1

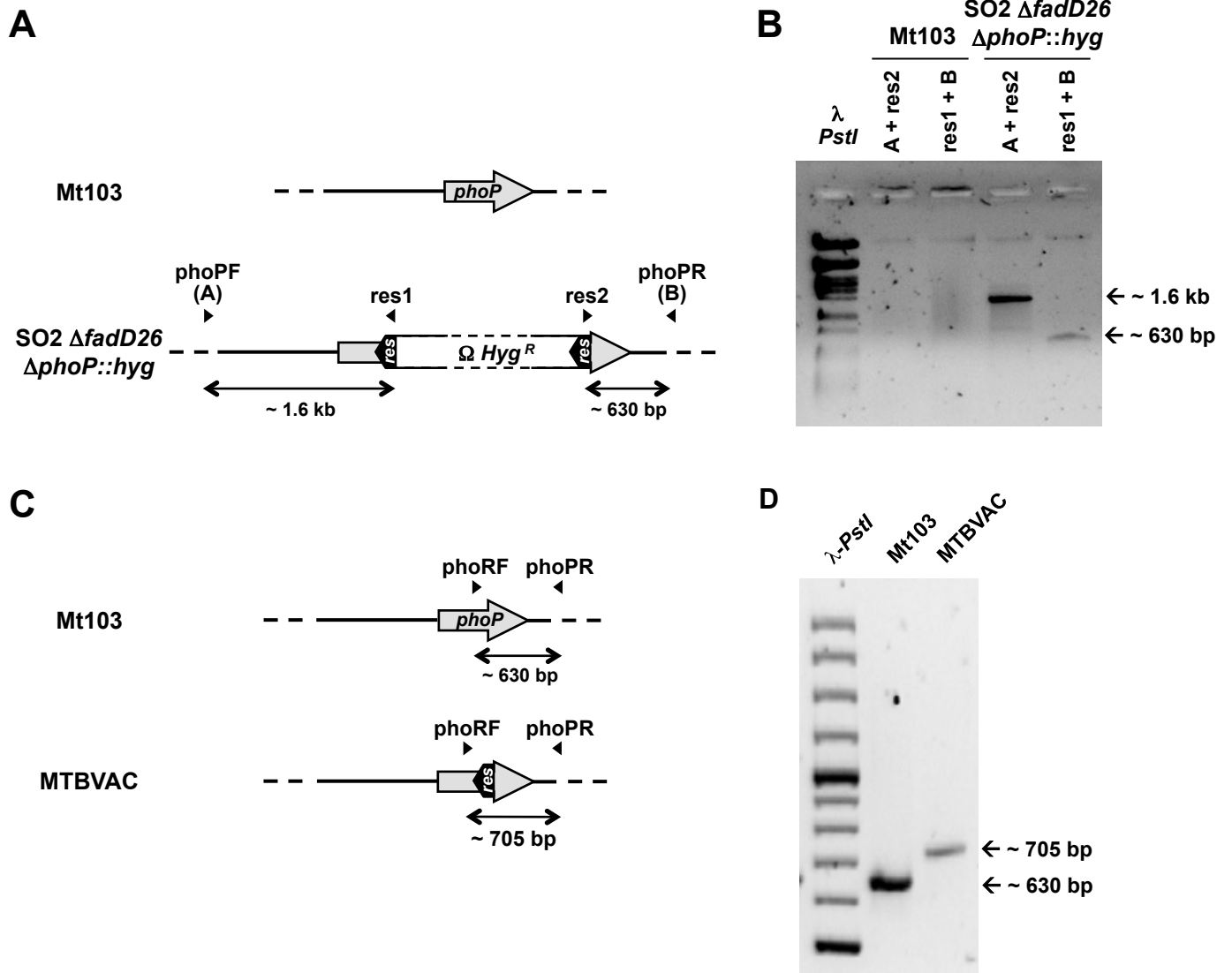
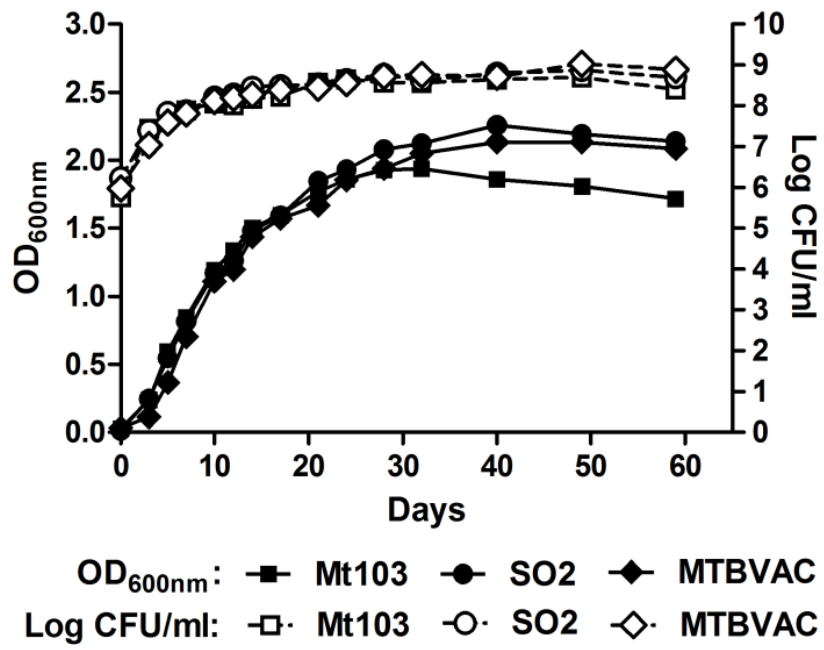

Figure S2



**A**



**B**

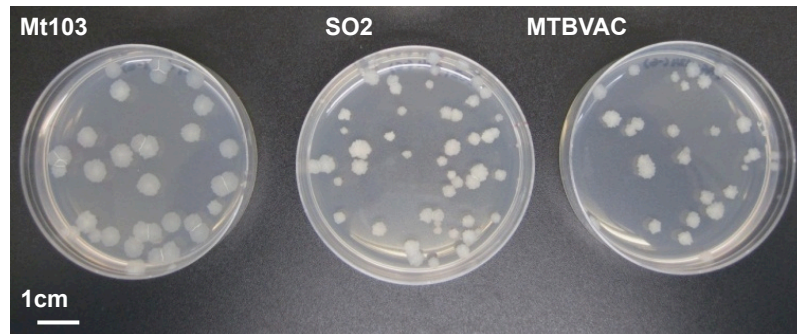

**Figure S3**

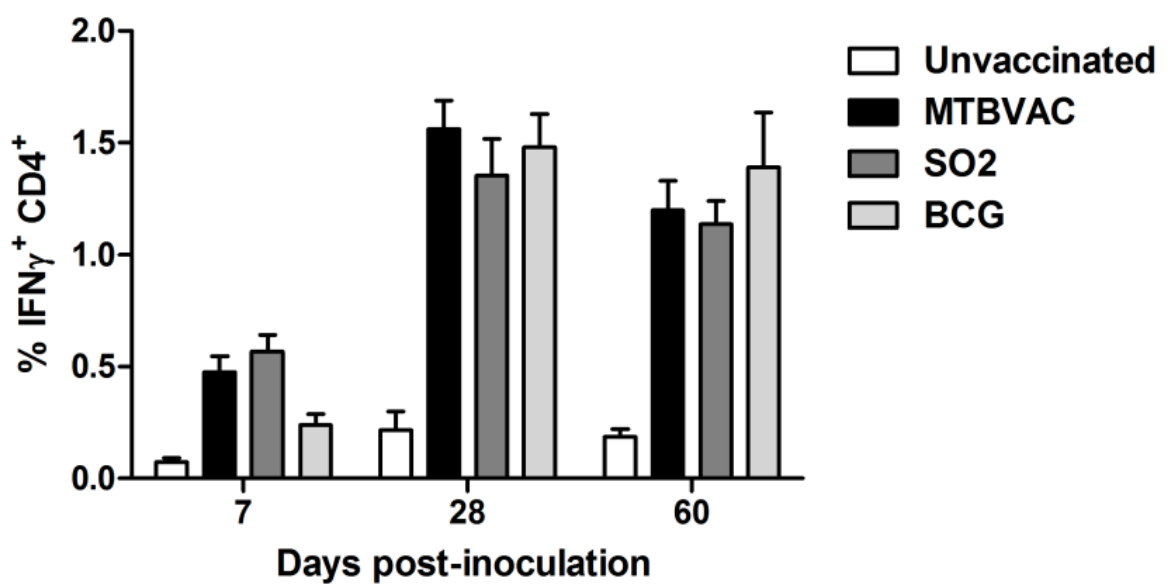

**Figure S4**